

TRES



IT CZ ENG

LISTINO PREZZI / CENÍK / PRICE LIST 2013

TRES

www.tresgriferia.com

Indice generale / Obecný seznam / Main index

SELEZIONE VÝBĚR SELECTION



Cuadro Exclusive **17**



Loft Colors **32**

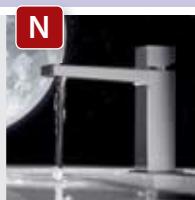

Slim-Tres **44**



Cuadro-Tres **65**



Max-Tres **100**



Loft-Tres **132**

MONO-TERM®



249

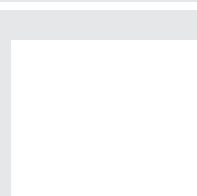

TRESMOSTATIC



Incassati
Vestavné
Built-in **260**



Termostatiche
doccia
Termostatické
baterie sprchy
Thermostatically-
controlled shower **266**



Termostatiche
vasca
Termostatické
baterie vany
Thermostatically-
controlled bathtub **274**



Gruppi
termostatici doccia
Termostatická
souprava sprchy
Thermostatically-
controlled shower sets **278**

CUCINA KUCHYNĚ KITCHEN



Cucina **336**
monocomando
Dřezové baterie s jedno-
pákovým
mechanismem
Kitchen mixer taps



Cucina con
manico estraibile **346**
Dřezová baterie
s výsuvnou sprškou
Kitchen taps with
detachable spray nozzle



Cucina due vie per
sistema di
trattamento acqua **350**
Dřezová baterie k úpravě vody
Kitchen taps for water
treatment



Cucina reclinabile **354**
Dřezová
baterie sklopná
Folding kitchen taps

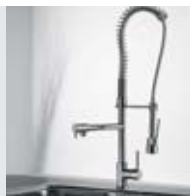

Cucina **356**
industriale
Dřezová baterie
průmyslová
Industrial kitchen taps



Cucina **360**
elettronica
Dřezové
elektronické baterie
Electronic kitchen taps

DOCCIA SPRCHY SHOWERS

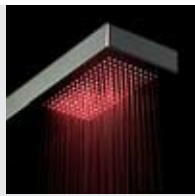

Chromotherapy **374**
Chromotherapy
Chromotherapy



Docce con luce **379**
Sprchy s
osvětlením
Showers with light



Docce da soffitto **380**
Stropní sprchy
Showers head



Docce a soffitto /
a parete **390**
Stropní sprchy /
Nástěnné sprchy
Showers head / Wall
showers



Asta antiscivolo **395**
Posuvná tyč
Sliding bar



Kit per doccia **403**
Sprchové soupravy
Shower kits

DISTRIBUZIONE DISTRIBUTIE DISTRIBUTION



Tempo-Tres **437**



K-Tres **444**



Prima **451**



Star-Tres **456**



Monotres 2000 **461**



Eco-Tres **467**

COMPLEMENTI PŘÍSLUŠENSTVÍ ACCESSORIES



Valvola **521**
Ventil
Valve



Scarico vasca **527**
Vanový sifon
Bath drain



Sifone **530**
Sifon
Siphon



Rosone **532**
Krycí rozeta
Cover plate



Erogatore Vasca **533**
Výtoková hubice
Spout



Chiave di **534**
regolazione
Uzavírací ventil
Adjustment key



Cub-Tres **152**



Lex-Tres **163**



Alplus **182**



Monoclastic 1900 **200**



Clasic-Tres **209**



Retro-Tres **220**



Bimax-Tres **237**



Gruppi termostatici vasca **292**
Termostatická souprava vany
Thermostatically-controlled bathtub sets



Gruppi termostatici classici **293**
Klasická termostatická souprava
Classic thermostatic control sets



Kit Sady **296**
Kits



Gruppi ad incasso **298**
Vestavěné soupravy
Built-in sets

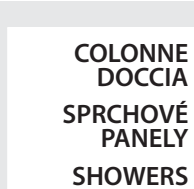

COLONNE DOCCIA
SPRCHOVÉ PANELY
SHOWERS COLUMNS



321



Cucina doppio comando **362**
Dřezová baterie kohoutková
Dual-control kitchen taps

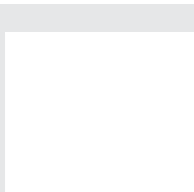

TRESTRONIC



RUBINETTERIA SPECIALE
SPECIÁLNÍ BATERIE
SPECIAL TAPWARE

495



ACCESSORI
VYBAVENÍ
ACCESORIES

502



509



Doccia **416**
Sprchy
Showers



Flessibili **430**
Hádice
Hoses



Supporti **432**
Podstavce
Supports



Portasapone **434**
Ostatní
Other



BM-Tres **473**



Ese-23 **480**

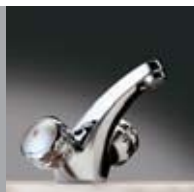

Ordal **487**



Altri **536**
Ostatní
Other



Limitatori di flusso **540**
Omezovače průtoku
Flow restrictors



Ariatore **540**
Perlátör
Aerator

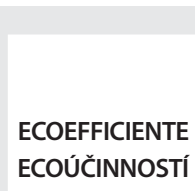

ECOEFFICIENTE
ECOÚČINNOSTÍ
EcoeffICIENT

542



BOX



552



LOFT COLORS



LOFT COLORS



SLIM-TRES



SLIM-TRES



DOCCIA / SPRCHY / SHOWERS



DOCCIA / SPRCHY / SHOWERS



MAX-TRES



MAX-TRES



MONO-TERM



MONO-TERM



ACCESSORI / VYBAVENÍ / ACCESORIES



ALPLUS



Ogni invenzione ha la sua origine...

Anno 1968. TRES rivoluziona il settore vinicolo con un nuovo rubinetto per vino dalla migliore chiusura ermetica. Questo nuovo rubinetto evita perdite di vino ed entrate di aria superflua, eliminando la schiuma durante la mescita.

Con la creazione di rubinetti per barrique di vino nasce lo spirito industriale di TRES.

Jakýkoli vynález má někde svůj původ...

Rok 1968. Společnost TRES uvádí na trh své revoluční výpustné kohoutky pro sektor vinařství, které zlepšují hermetické uzavření. Tyto nové kohoutky zabraňují ztrátám vína a nepotřebnému vstupu vzduchu, přičemž při výtoku se nevytváří pěna.

Vznikem výpustných kohoutků pro vinné sudy se tak rodí průmyslový duch společnosti TRES.

Every invention has its origin...

1968. TRES revolutionises the wine sector with a new wine tap with an improved hermetic seal. This new tap prevents wine loss and the entrance of unnecessary air, eliminating foam when dispensed.

From the creation of taps for wine casks emerges the industrial spirit of TRES.



Produciamo comfort da più di 40 anni...

TRES è un'azienda familiare che, nei suoi più di 40 anni di esperienza, si è dedicata alla fabbricazione integrale e commercializzazione di rubinetteria di prima qualità sia per bagni che per cucine.

La sua vasta gamma si adatta alle necessità del consumatore più esigente. L'alto grado tecnologico, insieme alla grande varietà estetica e al comfort, permettono qualsiasi soluzione per le nuove tendenze in arredamento di interni.

La fabbricazione integrale dei prodotti nei suoi moderni impianti ne permette la qualità e il controllo costante durante tutto il processo. Inoltre, il suo sistema di gestione che assicura le consegne e minimizza gli stock dei clienti fa di TRES un'azienda leader nel mercato europeo.

Více než 40 let vyrábíme komfort...

Společnost TRES je rodinný podnik, který se již po více než 40 let věnuje kompletní výrobě a prodeji baterií prvotřídní kvality pro koupelny i kuchyně.

Široký sortiment nabídky uspokojí potřeby i těch nejnáročnějších spotřebitelů. Špičková technologie a široká estetická paleta nabízejí jakékoli komfortní řešení pro nové tendence dekorace interiéru.

Kompletní výroba výrobků v moderních instalacích zaručuje kvalitu a neustálou kontrolu během celého procesu. Navíc, díky svému systému řízení, který zajišťuje dodávky a minimalizuje zásoby na skladě, je společnost TRES lídrem na evropském trhu.

Over 40 years manufacturing comfort...

TRES is a family company with more than 40 years of experience dedicated to the complete manufacture and marketing of top quality tapware for bathrooms and kitchens.

Its wide range of products meets the needs of even the most demanding consumer. Its state-of-the-art technology, along with a wide variety of styles and comfort, offer the right solution for new trends in interior design.

All its products are manufactured under one roof, in modern facilities capable of ensuring consistent quality and control throughout the production process. Its management system also guarantees deliveries and minimises client stocks, making TRES the leading company in the European market.





TRES • TRAINING • CENTER Vallirana (Barcelona)



TRES Grifería Vallirana (Barcelona)



TRES Portugal Cacém (Polonia)



TRES Polska Łódź (Portugal)

L'ampia gamma e l'alta qualità dei prodotti TRES sono riuscite a espandere il marchio nel mondo.

Le filiali in Germania, Portogallo e Polonia sono il frutto di molti anni di produzione di qualità, con un buon servizio e a un prezzo molto competitivo.

Díky široké paletě výrobků a jejich vysoké kvalitě jsou tak výrobky značky TRES známé po celém světě.

Dceřiné společnosti v Německu, Portugalsku a Polsku jsou výsledkem mnohaleté práce, kvalitních služeb a velmi příznivých cen.

The wide range and high quality of TRES products have led the brand to expand around the world. Subsidiaries in Germany, Portugal and Poland are the result of many years of commitment to quality products and good service at a very competitive price.



ISPIRAZIONE PER I TUOI SOGNI

INSPIRACE PRO VAŠE SNY

INSPIRATION FOR YOUR DREAMS



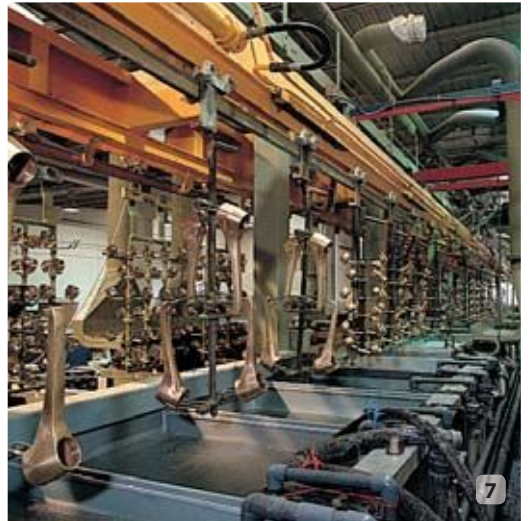
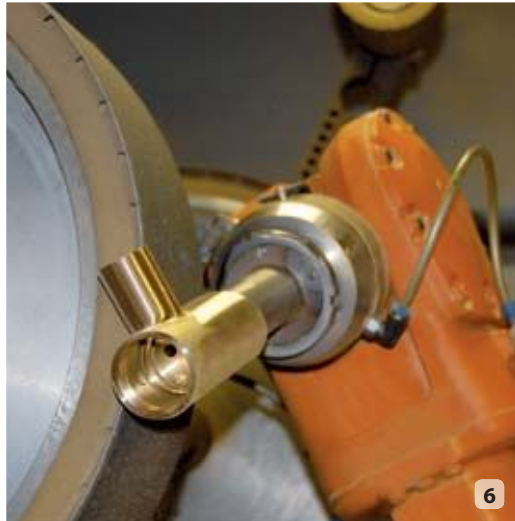
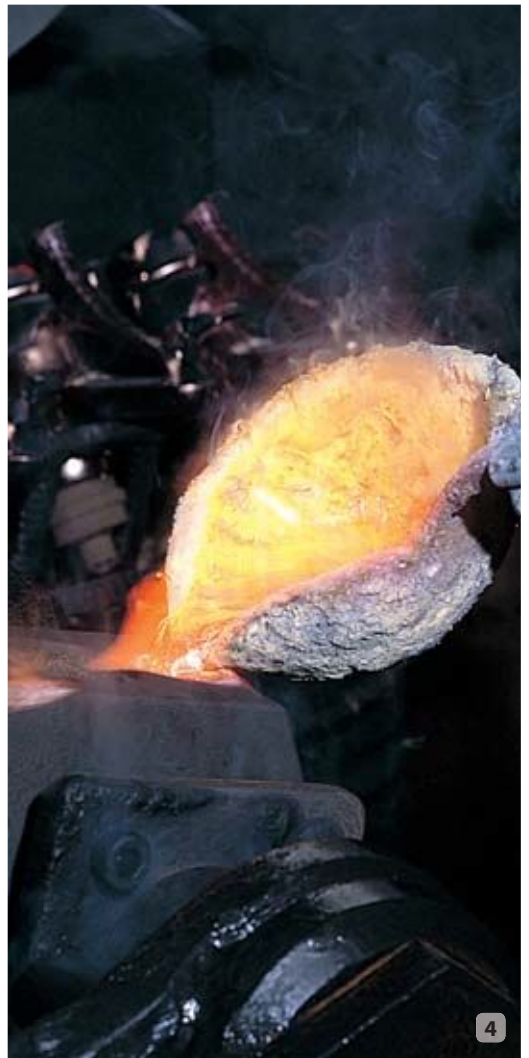



ACS



Pensato qui, progettato qui, fabbricato qui, per i consumatori di qui.... e anche per quelli all'estero...

In TRES estendiamo il controllo di qualità a tutti i processi di produzione, assicurando in tal modo un alto livello di qualità per tutti i nostri prodotti. L'uso di materie di prima qualità e un completo controllo dei processi di lavorazione dei materiali garantiscono al consumatore l'alta qualità del prodotto. Questo efficace metodo di controllo è possibile garantirlo soltanto se si producono i rubinetti dalla a alla z.

Vymyšlen zde, navržen zde, vyroben zde, pro zákazníky odsud... i odjinud...

Ve společnosti TRES provádíme kontrolu kvality ve všech výrobních procesech a zajišťujeme tím vysokou kvalitu veškerých našich výrobků. Využití prvotřídních materiálů a detailní kontrola manipulace s materiály zajišťuje spotřebitelům jedinečnou kvalitu produktů. Tuto efektivní kontrolní metodu lze garantovat pouze u výroby komplexního sortimentu baterií.

Devised here, designed here, manufactured here, for those here....and there...

At TRES, all production processes undergo quality control, ensuring a high level of quality for all the products we manufacture. The use of first-rate materials and exhaustive control over the material handling processes guarantee a high-quality product reaches the consumer. This effective control method can only be guaranteed by the start-to-finish production of our taps.

Laboratorio di ultima generazione, attrezzato per prove acustiche secondo la norma Europea EN 200-2008.

Laboratoř nejnovější generace vybavená pro akustické zkoušky dle evropské normy EN 200-2008.

State-of-the-art laboratory, equipped for noise testing according to European standard EN 200-2008.

Lingotto di ottone in lega CB7555 raffinato in Europa, con basso contenuto di piombo, conforme ai requisiti della norma Europea (UNE-EN1982)



Ingot z mosazi zušlechťené v Evropě ze slitiny CB7555 s nízkým obsahem olova, který splňuje požadavky evropské normy (UNE-EN1982)

Brass ingots refined in Europe from CB7555 alloys, with low lead levels, in compliance with the requirements of European standard UNE-EN1982.

Le barre di ottone provenienti dalla Germania, insieme ai controlli rigorosi a cui sono soggette al loro ricevimento, garantiscono indiscutibilmente la qualità che perseguiamo.



Mosazné tyče německého původu spolu s přísnými kontrolami při přebírání jsou nespornou zárukou kvality, o níž usilujeme.

Brass bars from Germany, in addition to strict receiving controls, are an irrefutable guarantee of the quality we're after.

Il procedimento galvanico TRES-MICRON®, frutto di 40 anni di esperienza e che assicura un perfetto livellamento dello spessore per le irregolarità superficiali dei pezzi, insieme a uno spessore medio molto regolare di 10-12 micron per il Nichel e di 0,25-0,35 micron per il Cromo, garantiscono un'elevatissima resistenza all'usura con una brillantezza duratura e inalterabile



Galvanický proces TRES-MICRON®, jenž je výsledkem čtyřicetiletých zkušeností, zaručuje dokonalé vyrovnání šířek na nepravidelném povrchu kusů a navíc velmi pravidelný průměr mikráže: 10-12 mikronů u niklu a 0,25-0,35 mikronů u chromu. To zajišťuje velmi vysokou odolnost vůči opotřebení a trvalý, neměnný lesk.

The TRES-MICRON® galvanic process, the product of 40 years of experience, ensures the perfect evening of thicknesses on irregular part surfaces, in addition to a very regular layer of 10-12 microns of nickel and 0.25-0.35 microns of chromium, guaranteeing extremely high resistance to wear with a long-lasting, persistent shine.

La verifica visuale e funzionale del 100% dei pezzi fa sì che i nostri prodotti superino con successo tutti i controlli che organismi ufficiali europei eseguono costantemente nei nostri impianti.

Díky vizuální a funkční kontrole všech součástí naše výrobky splňují požadavky všech neustálých auditů a kontrol našich závodů ze strany oficiálních evropských orgánů.

The visual and functional inspection of 100% of the parts contribute to our products consistently passing all audits carried out by official European entities at our facilities.



1 Design
Projekt
Design



2 Ingegneria
Inženýrství
Engineering



3 laboratorio
laboratoř
laboratory



4 Fusione
Tavba
Fusion



5 Meccanizzazione
Mechanické opracování
Mechanization



6 Pulitura
Hlazení
Polishing



7 Cromo
Chrom
Chrome



8 Montaggio
Montáž
Montage



9 Spedizione
Sklad
Expedition



10 Attenzione al cliente
Obsluha klienta
Customer service



TRES · TRAINING · CENTER

Uno spazio per sognare | Prostor pro snění | A space in which to dream

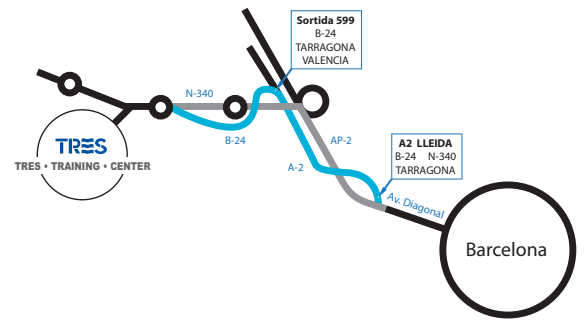

Dopo più di 40 anni dedicati alla qualità nell'ambito della rubinetteria, il marchio TRES ha ampliato di recente uno spettacolare showroom in cui presenta tutte le ultime novità.

Situato nel cuore delle vaste strutture di Vallirana, il TRES TRAINING CENTER è lo scenario ideale in cui conoscere in prima persona le novità e le proposte più innovative dell'azienda. Si tratta in totale di oltre 1000 mq trasformati in un'incredibile sala esposizioni che aspira a diventare il punto di incontro e di riferimento per tutti i professionisti del settore, dagli architetti e arredatori agli installatori professionisti fino ai responsabili dei punti vendita. Qui non solo è possibile scoprire l'ampia gamma di prodotti TRES, ma è stato inoltre abilitato uno spazio in cui poter impartire corsi di formazione ad agenti commerciali, distributori, ecc.

Společnost TRES se po více než 40 let věnuje rozvíjení kvality svých výrobků a nedávno rozšířila svůj velkolepý showroom, kde představuje všechny své novinky.

TRES TRAINING CENTER se nachází v srdci rozsáhlého areálu společnosti TRES ve městě Vallirana. Slouží jako ideální prostředí, v němž se můžete přímo seznámit s novinkami a nejdůležitějšími inovacemi firmy. Plocha o rozloze přes 1000 m² přebudovaná v ohromnou výstavní halu si klade za cíl stát se místem setkání a referenčním bodem pro všechny profesionály z odvětví, od architektů či dekorátérů až po profesionální instalatéry či pracovníky prodejen. Nejenže zde naleznete široký sortiment výrobků firmy TRES, ale i prostor, kde je možné pořádat školení pro obchodníky, distributory...

After more than 40 years dedicated to quality in the field of tapware, the TRES brand has recently expanded its spectacular showroom where it introduces all its new products.

Located in the heart of the company's vast facilities in Vallirana, the TRES TRAINING CENTER is the perfect setting to find out first hand about its new products and most innovative suggestions. An area of more than 1000 m² has been transformed into an impressive exhibition room, intended as a meeting place and a point of reference for all professionals in the sector, from architects and decorators to professional installers and those responsible for the points of sale. Here not only can you discover the wide range of TRES products, but there is also a space available to provide training courses for sales representatives, distributors, etc.





www.tresgriferia.com



Tutti i PRODOTTI TRES classificati in modo agile e intuitivo. Integriamo la ricerca con tutte le informazioni sul prodotto selezionato: manuale tecnico, caratteristiche, video, prodotti simili, ecc.

Všechny kódy VÝROBKŮ TRES, uspořádané přehledně a k rychlé orientaci. Vyhledávání doplňujeme veškerými informacemi o zvoleném výrobku: technickou příručkou, vlastnostmi, videi, podobnými výrobky atd.

All the TRES PRODUCTS, classified intuitively for quick retrieval. We complement this search with all the information about the chosen product: technical manual, characteristics, videos, similar products, etc.



Conoscete il lavoro che TRES svolge da più di 40 anni, il processo di fabbricazione, l'impegno esclusivo nel mondo della rubinetteria e l'incredibile possibilità di visitare il nostro TRES TRAINING CENTER.

Seznamte se s prací společnosti TRES, již se věnuje po více než 40 let, s procesem výroby a exkluzivním zaměřením na svět vodovodních baterií. Využijte skvělou příležitost a navštivte naše TRES TRAINING CENTER.

Come see the work that TRES has been carrying out for more than 40 years, its manufacturing process, and its exclusive dedication to the world of tapware and take advantage of the incredible opportunity to visit our TRES TRAINING CENTER.

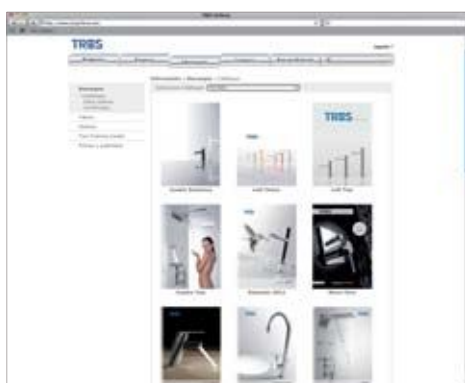

Tutte le INFORMAZIONI in un clic. Video esplicativi, cataloghi, fotografie, tariffe, ultime notizie,... tutto ciò di cui avete bisogno per lavorare e consultarvi rapidamente.

Stačí kliknout a získáte veškeré INFORMACE. Vysvětlující videa, katalogy, fotografie, ceníky, nejnovější zprávy – vše co potřebujete, abyste mohli pracovat a snadno a rychle získávat informace.

All the INFORMATION at a click of the mouse. Explanatory videos, catalogues, photographs, rates, news and more...just what you need to get advice and start work right away.

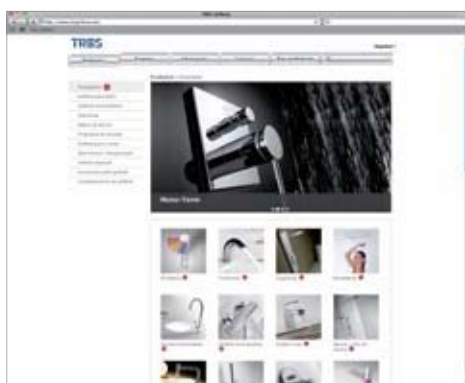

Cliccate di frequente nella finestra NOVITÀ e vedrete le ultime novità in rubinetteria, conoscerete meglio il marchio e sarete i primi a scoprire le novità dell'azienda di riferimento del settore.

Často si prohlížejte kartu NOVINKY – uvidíte ty nejnovější vodovodní baterie, blíže se seznámíte s naší značkou a jako první objevíte novinky firmy, která je v tomto sektoru pojmem.

Visit the LATEST DEVELOPMENTS section often to see the latest in tapware, learn more about the brand and be the first to discover the latest developments from the leading company in the sector.

NUOVO SITO WEB
NOVÁ WEBOVÁ STRÁNKA
NEW WEBSITE



ACCESSO PER I CLIENTI

VSTUP PRO KLIENTY

CUSTOMER ACCESS

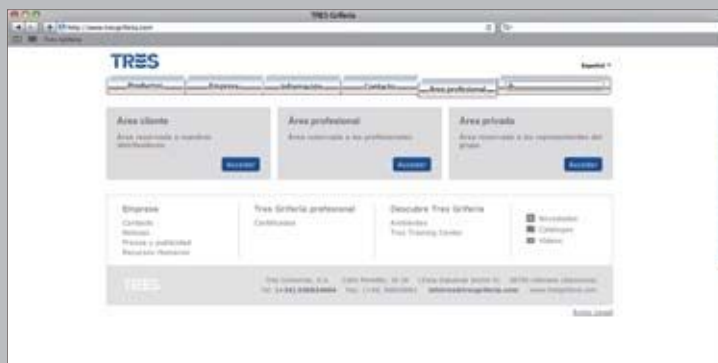

Approfitta dei vantaggi dei nostri servizi di e-commerce.

Využijte výhod naší služby elektronického obchodu.

Take advantage of the benefits of our e-commerce service.

PIÙ AGILE,
PIÙ INTUITIVA,
PIÙ PRATICA

RYCHLEJŠÍ,
INTUITIVNĚJŠÍ,
PRAKTIČTĚJŠÍ

FASTER,
MORE INTUITIVE,
MORE PRACTICAL

Registrandoti come cliente TRES, potrai accedere alla nostra area riservata e godere di numerosi vantaggi. Essendo più veloce, l'inserimento degli ordini online consente di risparmiare tempo e denaro e di avvalersi, inoltre, delle promozioni e degli sconti periodici riservati esclusivamente ai clienti del sito. Senza dimenticare la possibilità di conoscere lo stato di consegna del prodotto, visualizzare la situazione e lo storico degli ordini, stamparli, fare preventivi, consultare lo stock... Solo vantaggi, in modo rapido, facile e comodo.

Zaregistrujte se jako klient společnosti TRES a získáte přístup do její vyhrazené sekce, kde můžete využít nabízených výhod. Zadávaní objednávek je rychlejší, protože je můžete dělat online. Ušetříte tak čas i peníze, budete totiž moci využít pravidelných promočních nabídek a slev určených pouze pro webové stránky. Kromě toho můžete výrobek sledovat, zobrazit stav a vývoj svých objednávek, vytisknout si je a dělat kalkulace, nahlédnout do našich zásob atd.

Jen výhody: rychle, snadno a pohodlně.

By registering as a TRES customer, you can access our private area where you can enjoy special benefits. Orders are placed faster since you can enter them online, saving time and money while also benefiting from regular promotions and discounts offered exclusively on our website. In addition, you can track products, see the status and history of your orders, print them and create quotes, consult our stock, etc.

These are just some of the advantages of a faster, easier and more convenient way to shop.

Informatevi e iscrivetevi a:

Informace získáte a zaregistrovat se můžete na:
For more information or to register, please go to:

usuariostres@tresgriferia.com | +34 93 683 40 04



Cuadro Exclusive **17**



Loft Colors **32**



Slim-Tres **44**



Cuadro-Tres **65**

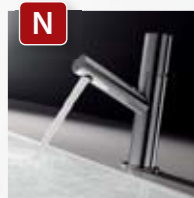

Max-Tres **100**



Loft-Tres **132**



Cub-Tres **152**



Lex-Tres **163**



Alplus **182**



Monoclastic 1900 **200**



Clasic-Tres **209**



Retro-Tres **220**



Bimax-Tres **237**



Mono-Term® **249**

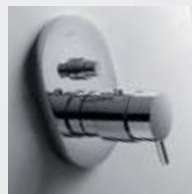

Termostatica incassata **260**
Vestavěné
Termostatické baterie
Built-in Thermostatic taps



Termostatica di superficie **266**
Povrchové
termostatické baterie
Surface thermostatic taps



Gruppi termostatici **278**
Soupravy termostatických
baterií
Thermostatic tap sets



Gruppi incassati **298**
Soupravy
Vestavěných baterií
Built-in sets



Colonne doccia **321**
Sprchové panely
Shower columns



Cucina **331**
Kuchyně
Kitchen



CUADRO EXCLUSIVE



LOFT COLORS



SLIM-TRES



CUADRO-TRES



MAX-TRES



LOFT-TRES



CUB-TRES



LEX-TRES



ALPLUS



MONOCLASIC 1900



CLASIC-TRES



RETRO-TRES



BIMAX-TRES



MONO-TERM®



TERMOSTATICA INCASSATA
VESTAVĚNÉ TERMOSTATICKÉ BATERIE
BUILT-IN THERMOSTATIC TAPS



TERMOSTATICA DI SUPERFICIE
POVRCHOVÉ TERMOSTATICKÉ BATERIE
SURFACE THERMOSTATIC TAPS



GRUPPI TERMOSTATICI
SOUPRAVY TERMOSTATICKÝCH BATERIÍ
THERMOSTATIC TAP SETS



GRUPPI INCASSATI
SOUPRAVY VESTAVĚNÝCH BATERIÍ
BUILT-IN SETS



COLONNE DOCCIA
SPRCHOVÉ PANELY
SHOWER COLUMNS



CUCINA
KUCHYNĚ
KITCHEN



NERO-CROMO/ČERNÁ-CHROM/
BLACK-CHROME
BIANCO-CROMO/BÍLA-CHROM/
WHITE-CHROME



4.07.103.03

CUADRO EXCLUSIVE



CUADRO EXCLUSIVE





6.06.161.02 + 1.06.245



CUADRO EXCLUSIVE





6.07.174.9



4.07.170.02

CUADRO EXCLUSIVE



6.07.103.03

4.06.107.02



6.06.980

CUADRO EXCLUSIVE





NERO-CROMO/ČERNÁ-CHROM/
BLACK-CHROME
BIANCO-CROMO/BILÁ-CHROM/
WHITE-CHROME

6.07.170.02



4.07.164.9

CUADRO EXCLUSIVE



NERO-CROMO/ČERNÁ-CHROM/
BLACK-CHROME
BIANCO-CROMO/BÍLÁ-CHROM/
WHITE-CHROME

CUADRO EXCLUSIVE

Vernici ecologiche senza solventi / Ekologické barvy, bez rozpouštědel / Eco-friendly solvent-free paints



Lavabi / Umyvadla / Basins Ref. / Kód / Nr.:



Monocomando lavabo con bocca a cascata
Umyvadlová baterie s přívalovým přítokem
Single lever washbasin mixer with cascade cast spout

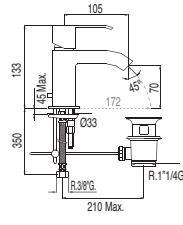

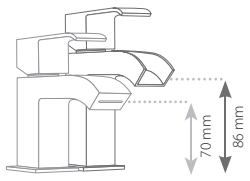

91.30.190	6.06.103.02	4.06.103.02
91.30.190	6.06.103.02.DA	4.06.103.02.DA

*** NOTA:** La rubinetteria con canna a cascata è accompagnata da 2 rubinetti di regolazione con filtro (Ref: 91.34.525)

*** POZNÁMKA:** Baterie typu vodopádu je doplněna dvěma regulačními kohouty s filtrem (Kód: 91.34.525)

*** NOTE:** Taps with a cascade spout come with 2 regulation valves and a filter (Nr.: 91.34.525)



Monocomando lavabo con prolunga inferiore con bocca a cascata
Umyvadlová baterie s prodlužkou s přívalovým přítokem
Single lever washbasin mixer with cascade cast spout

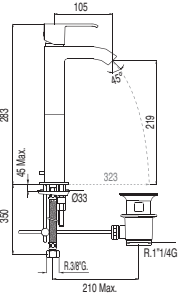

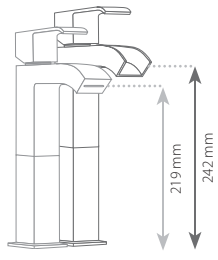

91.30.190	6.06.107.02	4.06.107.02
91.30.190	6.06.107.02.DA	4.06.107.02.DA

*** NOTA:** La rubinetteria con canna a cascata è accompagnata da 2 rubinetti di regolazione con filtro (Ref: 91.34.525)

*** POZNÁMKA:** Baterie typu vodopádu je doplněna dvěma regulačními kohouty s filtrem (Kód: 91.34.525)

*** NOTE:** Taps with a cascade spout come with 2 regulation valves and a filter (Nr.: 91.34.525)

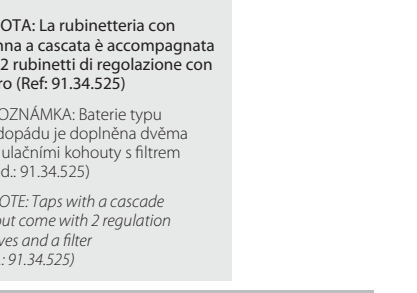

Monocomando lavabo con prolunga inferiore con bocca a cascata
Umyvadlová baterie s prodlužkou s přívalovým přítokem
Single lever washbasin mixer with cascade cast spout

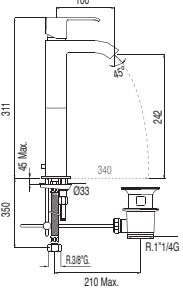



91.30.190	6.06.107.03	4.06.107.03
91.30.190	6.06.107.03.DA	4.06.107.03.DA

● = Nero-Cromo/Černá-Chrom/Black-Chrome ○ = Bianco-Cromo/Bílá-Chrom/White-Chrome

Ordine speciale - Tempi di consegna di 4 Settimane /
Zvláštní objednávka - Dodací lhůta 4 týdny /
Special order - Delivery time of 4 weeks

Raccomandabile installare la valvola SIMPLE RAPID (non inclusa)
Doporučuje se použít ventil Simple Rapid (není v ceně)
Ideal assembly with SIMPLE RAPID valve (This is not included)

CUADRO EXCLUSIVE

Ref. / Kód / Nr.:



Monocomando lavabo con bocca a cascata

Umyvadlová baterie s přivalovým přítokem

Single lever washbasin mixer with cascade cast spout

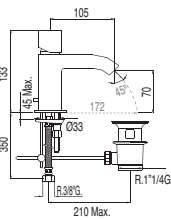
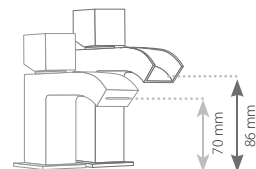

6.07.103.02
4.07.103.02



6.07.103.02.DA
4.07.103.02.DA

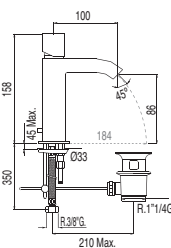

6.07.103.03
4.07.103.03



6.07.103.03.DA
4.07.103.03.DA

* NOTA: La rubinetteria con canna a cascata è accompagnata da 2 rubinetti di regolazione con filtro (Ref: 91.34.525)

* POZNÁMKA: Baterie typu vodopádu je doplněna dvěma regulačními kohouty s filtrem (Kód: 91.34.525)

* NOTE: Taps with a cascade spout come with 2 regulation valves and a filter (Nr.: 91.34.525)



Monocomando lavabo con prolunga inferiore con bocca a cascata

Umyvadlová baterie s prodlužkou s přivalovým přítokem

Single lever washbasin mixer with cascade cast spout

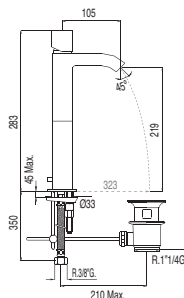
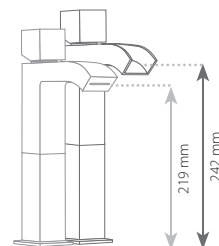

6.07.107.02
4.07.107.02



6.07.107.02.DA
4.07.107.02.DA

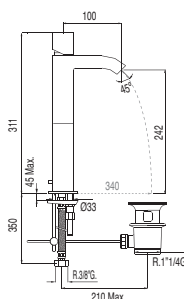

6.07.107.03
4.07.107.03



6.07.107.03.DA
4.07.107.03.DA

* NOTA: La rubinetteria con canna a cascata è accompagnata da 2 rubinetti di regolazione con filtro (Ref: 91.34.525)

* POZNÁMKA: Baterie typu vodopádu je doplněna dvěma regulačními kohouty s filtrem (Kód: 91.34.525)

* NOTE: Taps with a cascade spout come with 2 regulation valves and a filter (Nr.: 91.34.525)

● = Nero-Cromo/Černá-Chrom/Black-Chrome

○ = Bianco-Cromo/Bílá-Chrom/White-Chrome

Raccomandabile installare la valvola SIMPLE RAPID (non inclusa)
Doporučuje se použít ventil Simple Rapid (není v ceně)
Ideal assembly with SIMPLE RAPID valve (This is not included)

NERO-CROMO/ČERNÁ-CHROM/
BLACK-CHROME
BIANCO-CROMO/BÍLÁ-CHROM/
WHITE-CHROME

Vernici ecologiche senza solventi / Ekologické barvy, bez rozpouštědel / Eco-friendly solvent-free paints



Bidet / Bidety / Bidets Ref. / Kód / Nr.:

Monocomando bidet

Bidetová baterie

Single lever bidet mixer

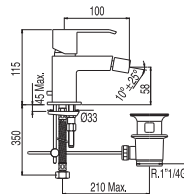

6.06.120
4.06.120



6.06.120.DA
4.06.120.DA

Monocomando bidet

Bidetová baterie

Single lever bidet mixer

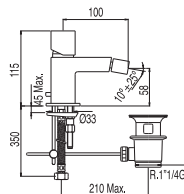

6.07.120
4.07.120



6.07.120.DA
4.07.120.DA

Monocomandi bagno / Jednopákový mechanismus vany / Bathtub mixer taps Ref. / Kód / Nr.:

Monocomando doccia

Doccia anticalcarea. Flessibile satin (91.34.609.15).

Sprchová baterie

Sprchová hadice satin (91.34.609.15).

Single lever shower mixer

Shower Antilime. Shower hose satin (91.34.609.15).

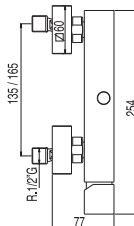

OTTONE
MOSAZ
BRASS



6.07.167
4.07.167

Monocomando vasca

Con bocca a cascata. Doccia anticalcarea. Flessibile satin (91.34.609).

Vanová baterie

S kaskádou, sprchová koncovka se systémem proti tvorbě vodního kamene. Sprchová hadice satin (91.34.609).

Single lever bath and shower mixer

with cascade. Shower Antilime. Shower hose satin (91.34.609).

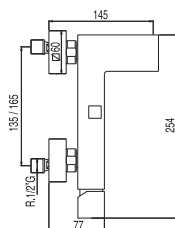

OTTONE
MOSAZ
BRASS



6.07.170.02
4.07.170.02

● = Nero-Cromo/Černá-Chrom/Black-Chrome ○ = Bianco-Cromo/Bílá-Chrom/White-Chrome

Ordine speciale - Tempi di consegna di 4 Settimane /
Zvláštní objednávka - Dodací lhůta 4 týdny /
Special order - Delivery time of 4 weeks



Raccomandabile installare la valvola SIMPLE RAPID (non inclusa)
Doporučuje se použít ventil Simple Rapid (není v ceně)
Ideal assembly with SIMPLE RAPID valve (This is not included)

NERO-CROMO/ČERNÁ-CHROM/
BLACK-CHROME

BIANCO-CROMO/BÍLÁ-CHROM/
WHITE-CHROME

CUADRO EXCLUSIVE

Bordovasca / Vany s prodlouženým pultem / Deck-mounted bathtubs

Ref. / Kód / Nr.:



Monocomando bordo vasca

Con bocca a cascata, doccia anticalcarea

Vanová 3-otvorová stojánková baterie s progresivním regulátorem

S přívalovým vtokem, sprchová koncovka se systémem proti tvorbě vodního kamene

Bath-shower single lever tap for bracket shelf with cascade cast spout and shower antilime

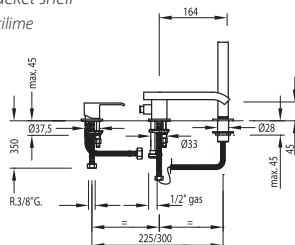

OTTONE
MOSAZ
BRASS



6.06.161.02

4.06.161.02



Kit bordo vasca

Facile montaggio superiore. Senza registro

Montážní sada k 3-otvorové baterii s odtokem zbytků vody

Snadná montáž/demontáž seshora. Není nutné montovat dodatečné revizní prvky u vany

Bath-shower kit cistern

easy upper assembly, without installation

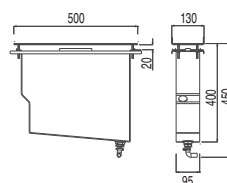

Brevettato®

Patentovaný®

Patented®

Cr

1.06.245



Valvola vasca con presa drenaggio

Vanový sifon typu click-clack s přípojkou k odtokovému systému 3-otvorové baterie

Bath valve with drainage point

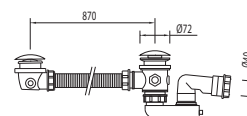

Cr

1.34.445

Ad incasso / Vestavěné / Built-in

Ref. / Kód / Nr.:



Monocomando ad incasso doccia

Podomítková sprchová baterie

Single lever concealed shower mixer

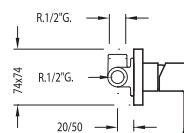

6.06.177

4.06.177



Monocomando incasso bagno doccia con deviatore

Podomítková vanová baterie s ruční sprchou

Single lever concealed bath and shower mixer

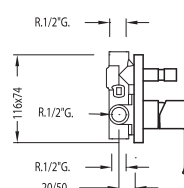

6.06.180

4.06.180

● = Nero-Cromo/Černá-Chrom/Black-Chrome

○ = Bianco-Cromo/Bílá-Chrom/White-Chrome

Cr = Cromo/Chrom/Chrome

Ordine speciale - Tempi di consegna di 4 Settimane /
Zvláštní objednávka - Dodací lhůta 4 týdny /
Special order - Delivery time of 4 weeks



Gruppi ad incasso / Vestavěné soupravy / Built-in sets

Ref. / Kód / Nr.:

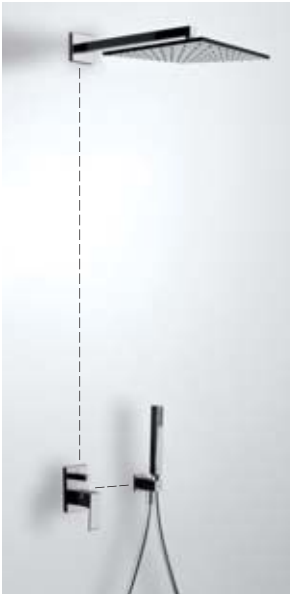

Kit doccia ad incasso CUADRO EXCLUSIVE

Con chiusura e regolazione di portata. Doccia fissa da 300x300 mm. Supporto per doccia. Doccia anticalcarea. Flessibile satin (91.34.609.15).

Podomítkový set se sprchou CUADRO EXCLUSIVE

S uzávěrem a regulací průtoku. Hlavová sprcha 300x300 mm. Pevný držák s vodní přípojkou pro hadic. Sprchová koncovka se systémem proti tvorbě vodního kamene. Hadice satin (91.34.609.15).

Concealed shower set CUADRO EXCLUSIVE

with water shut off and flow control. Fixed shower head 300x300 mm. Brass. Elbow wall. Antilime hand shower. Satin hose (91.34.609.15).

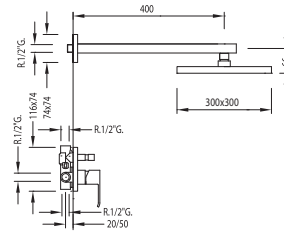

OTTONE
MOSAZ
BRASS



OTTONE
MOSAZ
BRASS



91.30.190



6.06.980

4.06.980



Kit doccia ad incasso CUADRO EXCLUSIVE

Con chiusura e regolazione di portata. Doccia fissa da 300x300 mm. Supporto per doccia. Doccia anticalcarea. Flessibile satin (91.34.609.15).

Podomítkový set se sprchou CUADRO EXCLUSIVE

S uzávěrem a regulací průtoku. Hlavová sprcha 300x300 mm. Pevný držák s vodní přípojkou pro hadic. Sprchová koncovka se systémem proti tvorbě vodního kamene. Hadice satin (91.34.609.15).

Concealed shower set CUADRO EXCLUSIVE

with water shut off and flow control. Fixed shower head 300x300 mm. Brass. Elbow wall. Antilime hand shower. Satin hose (91.34.609.15).

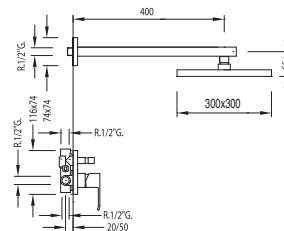

OTTONE
MOSAZ
BRASS



OTTONE
MOSAZ
BRASS



91.30.190



6.06.985

4.06.985

NERO-CROMO/ČERNÁ-CHROM/
BLACK-CHROME

BIANCO-CROMO/BÍLÁ-CHROM/
WHITE-CHROME

CUADRO EXCLUSIVE

Termostatiche / Termostatické / Thermostatically-controlled

Ref. / Kód / Nr.:



Doccia CUADRO EXCLUSIVE termostatica
Doccia anticalcarea. Flessibile satin (91.34.609.15).

Termostatická sprchová baterie
CUADRO EXCLUSIVE

Sprchová hadice satin (91.34.609.15).

Wall thermostatic shower mixer
CUADRO EXCLUSIVE

Shower Antilime. Shower hose satin (91.34.609.15).

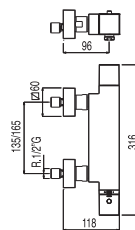

OTTONE
MOSAZ
BRASS



TRES TOUCH-COOL®



6.07.164.9

4.07.164.9



Vasca-Doccia CUADRO EXCLUSIVE
termostatica

Con bocca a cascata. Doccia anticalcarea.
Flessibile satin (91.34.609).

Termostatická vanová a sprchová baterie
CUADRO EXCLUSIVE

S kaskádou, sprchová hadice satin (91.34.609).

Wall thermostatic bath and shower mixer
CUADRO EXCLUSIVE

with cascade. Shower Antilime and Satin hose
(91.34.609).

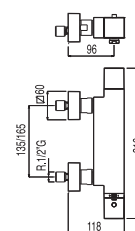

OTTONE
MOSAZ
BRASS



TRES TOUCH-COOL®



6.07.174.9

4.07.174.9

Gruppi termostatici / Termostatické soupravy / Thermostatically-controlled sets

Ref. / Kód / Nr.:



Set doccia CUADRO EXCLUSIVE termostatica
doccia fissa da 300x300 mm. Ottone. Doccia anticalcarea.
Flessibile satin (91.34.609.15). Invertitore integrato nel
regolatore di portata (si veda pagina 576)

Termostatický sprchový set CUADRO EXCLUSIVE

Hlavová sprcha 300x300 mm. Mosaz. Ruční sprchy se systémem proti
vzniku vodního kamene (91.34.609.15). Přepínač proudů integrovaný s
regulátorem tlaku (viz str. 576)

Wall thermostatic shower mixer CUADRO EXCLUSIVE

fixed shower head 300x300 mm. Brass. Antilime hand shower. Satin hose
(91.34.609.15). Diverter integrated in the flow control (see page 576)

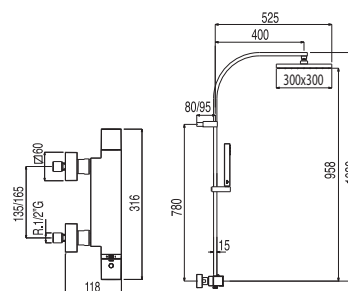

OTTONE
MOSAZ
BRASS



OTTONE
MOSAZ
BRASS



TRES TOUCH-COOL®



6.07.395

4.07.395

● = Nero-Cromo/Černá-Chrom/Black-Chrome

○ = Bianco-Cromo/Bílá-Chrom/White-Chrome

Ordine speciale - Tempi di consegna di 4 Settimane /
Zvláštní objednávka - Dodací lhůta 4 týdny /
Special order - Delivery time of 4 weeks

NERO-CROMO/ČERNÁ-CHROM/
BLACK-CHROME
BIANCO-CROMO/BÍLÁ-CHROM/
WHITE-CHROME

Vernici ecologiche senza solventi / Ekologické barvy, bez rozpouštědel / Eco-friendly solvent-free paints



Ref. / Kód / Nr.:



Kit doccia termostatica CUADRO EXCLUSIVE

Con chiusura e regolazione di portata. (2 vie) Doccia fissa da 300x300 mm. Ottone. Supporto per doccia. Doccia anticalcare. Flessibile satin (91.34.609.15).

Termostatický sprchový set CUADRO EXCLUSIVE

S uzávěrem a regulací průtoku. (Dvoucestný) Hlavová sprcha 300x300 mm. Mosaz. Pevný držák s vodní přípojkou pro hadic. Sprchová koncovka se systémem proti tvorbě vodního kamene. Hadice satin (91.34.609.15).

Thermostatic bar-shower CUADRO EXCLUSIVE

*with water shut off and flow control. (2 ways)
Fixed shower head 300x300 mm. Brass. Elbow wall.
Antilime hand shower. Satin hose (91.34.609.15).*

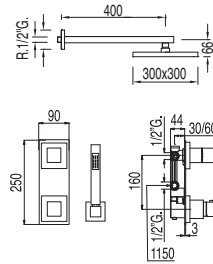

OTTONE
MOSAZ
BRASS



OTTONE
MOSAZ
BRASS



6.07.175

4.07.175

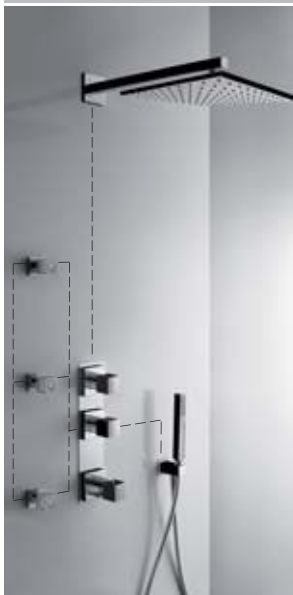

Kit doccia termostatica CUADRO EXCLUSIVE

Con chiusura e regolazione di portata. (3 vie) Doccia fissa da 300x300 mm. Ottone. Supporto per doccia. Doccia anticalcare. Flessibile satin (91.34.609.15).

Termostatický sprchový set CUADRO EXCLUSIVE

S uzávěrem a regulací průtoku. (Trojcestný) Hlavová sprcha 300x300 mm. Mosaz. Pevný držák s vodní přípojkou pro hadic. Sprchová koncovka se systémem proti tvorbě vodního kamene. Hadice satin (91.34.609.15).

Thermostatic bar-shower CUADRO EXCLUSIVE

*with water shut off and flow control. (3 ways)
Fixed shower head 300x300 mm. Brass. Elbow wall.
Antilime hand shower. Satin hose (91.34.609.15).*

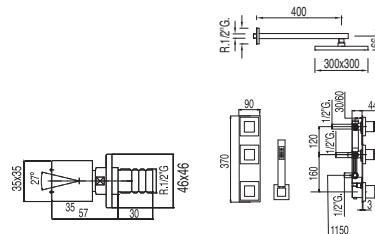

OTTONE
MOSAZ
BRASS



OTTONE
MOSAZ
BRASS



6.07.178

4.07.178

● = Nero-Cromo/Černá-Chrom/Black-Chrome ● = Bianco-Cromo/Bílá-Chrom/White-Chrome

Ordine speciale - Tempi di consegna di 4 Settimane /

Zvláštní objednávka - Dodací lhůta 4 týdny /

Special order - Delivery time of 4 weeks

CUADRO EXCLUSIVE

Ref. / Kód / Nr.:



Batteria vasca termostatica
Con bocca a cascata, doccia anticalcearia.
Flessibile satin (91.34.609).

Termostatická podomítková vanová baterie
se sprchou
S přívalovým vtokem, sprchová koncovka se systémem
proti tvorbě vodního kamene. Hadice satin (91.34.609).

Thermostatic bath
with cascade cast spout. Antilime hand shower.
Satin hose (91.34.609).



TRES BLOCK-SYSTEM

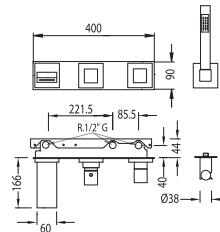

OTTONE
MOSAZ
BRASS



6.07.192



4.07.192



Bocca a cascata set doccia
Přívalovým přítokem vanový set
Cascade cast spout bath mixer

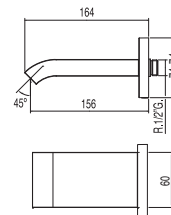









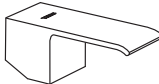

6.07.181

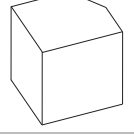
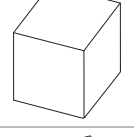
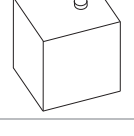
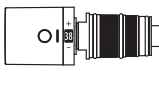
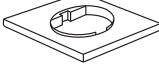

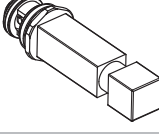
4.07.181

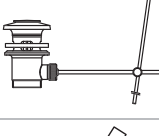
Ricambi / Náhradní díly / Spare parts

	Manopola Úchyt <i>Lever</i>		91.06.020.6 91.06.020.4	
	Volano Otočný ovladač <i>Handle</i>		91.07.030.6 91.07.030.4	
	Volano Lato portata Otočný ovladač na straně regulace proudu vody <i>Handle Flow side</i>	(per ref. / Kód / for Nr.: 07.164, 07.164.9, 07.174, 07.174.9)	91.94.006.6 91.94.006.4	
	Volano Lato portata Otočný ovladač na straně regulace proudu vody <i>Handle Flow side</i>	(per ref. / Kód / for Nr.: 07.395)	91.94.006.26 91.94.006.24	
	Manopola lato temperatura Kohoutek na straně s regulací teploty <i>Temperature side handle</i>	(per ref. / Kód / for Nr.: 07.164, 07.164.9, 07.174, 07.174.9, 07.395)	91.07.030.26 91.07.030.24	
	Cartuccia termostatica + volano Termostatická vložka s otočným ovladačem <i>Thermostatic cartridge stem + Handle</i>	(per ref. / Kód / for Nr.: 07.164, 07.174, 07.395)	91.06.161.16 91.06.161.14	
	Base lavabo Ozdobný kroužek pod umyvadlovou baterií <i>Mixer base</i>			Cr 91.06.100.01
	Rotula Bidetové klouby <i>Ball-and-sucket joint bidet mixer</i>			Cr 91.07.672
	Invertitore Přepínač <i>Diverter</i>	(per ref. / Kód / for Nr.: 06.180)		91.06.180.26 91.06.180.24
	Aeratore a scomparsa e chiusura Vnitřní perlátor + klíč <i>Aerator + key</i>			Cr 91.34.665
	Scarico automatico Automatický odtok <i>Pup-up waste</i>	1,1/4"		Cr 91.34.375.10
	Set asta e pulsante Sada přepínače s vedením a úchytem <i>Button and rod set</i>			Cr 91.34.375

LOFT COLORS



200.205.01.BLD

LOFT COLORS





200.164.09.VE



200.170.01.FU



200.205.06.AM.D

LOFT COLORS

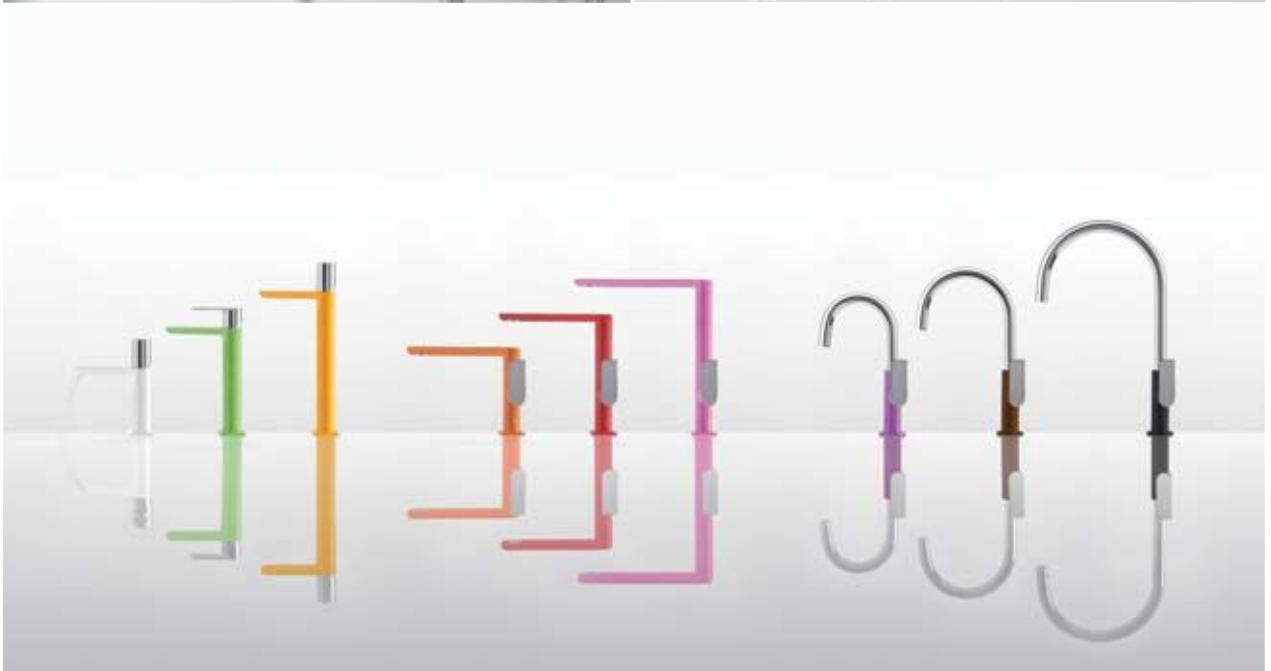



200.110.02.FU.D



200.180.02.AM

LOFT COLORS





200.250.07.VE

LOFT COLORS



I colori sono orientativi, dipendendo dal supporto di riproduzione
 Odstíny barev jsou orientační, závisí na možnostech prostředků, pomocí nichž jsou zobrazeny
 Colours are for reference purposes only, and are subject to the limitations of the medium used to display them

LOFT COLORS

Vernici ecologiche senza solventi / Ekologické barvy, bez rozpouštědel / Eco-friendly solvent-free paints



Lavabi / Umyvadla / Basins

Ref. / Kód / Nr.:

N

Monocomando lavabo
 Umyvadlová baterie
 Single lever washbasin mixer

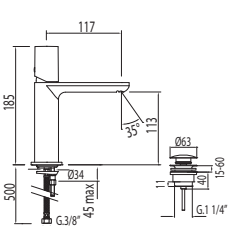

	200.103.02.AM.D
	200.103.02.NA.D
	200.103.02.RO.D
	200.103.02.VI.D
	200.103.02.FU.D
	200.103.02.VE.D
	200.103.02.MA.D
	200.103.02.NE.D
	200.103.02.BL.D

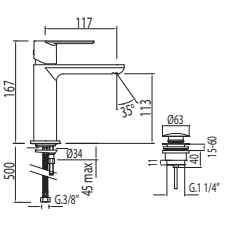

	200.103.01.AM.D
	200.103.01.NA.D
	200.103.01.RO.D
	200.103.01.VI.D
	200.103.01.FU.D
	200.103.01.VE.D
	200.103.01.MA.D
	200.103.01.NE.D
	200.103.01.BL.D

N

Monocomando lavabo
 con bocca a cascata aperta
 Umyvadlová baterie
 výtok otevřená kaskáda
 Single lever washbasin mixer
 with open cascade spout

* NOTA: La rubinetteria con canna a cascata è accompagnata da 2 rubinetti di regolazione con filtro (Ref: 91.34.525)
 * POZNÁMKA: Baterie typu vodopádu je doplněna dvěma regulačními kohouty s filtrem (Kód: 91.34.525)
 * NOTE: Taps with a cascade spout come with 2 regulation valves and a filter (Nr.: 91.34.525)

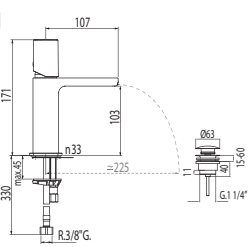

	200.110.02.AM.D
	200.110.02.NA.D
	200.110.02.RO.D
	200.110.02.VI.D
	200.110.02.FU.D
	200.110.02.VE.D
	200.110.02.MA.D
	200.110.02.NE.D
	200.110.02.BL.D

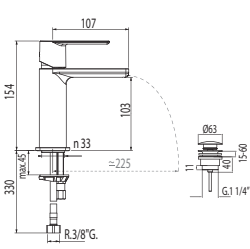

	200.110.01.AM.D
	200.110.01.NA.D
	200.110.01.RO.D
	200.110.01.VI.D
	200.110.01.FU.D
	200.110.01.VE.D
	200.110.01.MA.D
	200.110.01.NE.D
	200.110.01.BL.D

Ordine speciale - Tempi di consegna di 4 Settimane /
 Zvláštní objednávka - Dodací lhůta 4 týdny /
 Special order - Delivery time of 4 weeks

= si veda pagina/viz ste/see page 598

Valvola SIMPLE RAPID (Allegata)
 Ventil Simple Rapid (Zahrnutý)
 SIMPLE RAPID valve (Included)

N



**Monocomando lavabo
con prolunga inferiore**

Umyvadlová baterie

S prodlužkou

Single lever washbasin mixer

with base extension

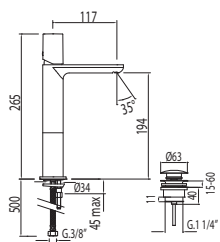

- 200.103.04.AM.D
- 200.103.04.NA.D
- 200.103.04.RO.D
- 200.103.04.VI.D
- 200.103.04.FU.D
- 200.103.04.VE.D
- 200.103.04.MA.D
- 200.103.04.NE.D
- 200.103.04.BL.D

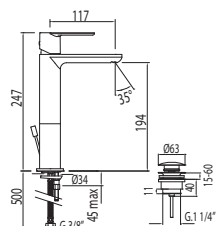

- 200.103.03.AM.D
- 200.103.03.NA.D
- 200.103.03.RO.D
- 200.103.03.VI.D
- 200.103.03.FU.D
- 200.103.03.VE.D
- 200.103.03.MA.D
- 200.103.03.NE.D
- 200.103.03.BL.D

N



**Monocomando lavabo
con prolunga inferiore**

Umyvadlová baterie

S prodlužkou

Single lever washbasin mixer

with base extension

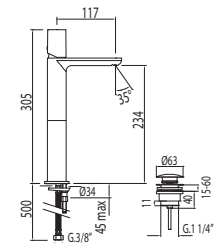

- 200.103.06.AM.D
- 200.103.06.NA.D
- 200.103.06.RO.D
- 200.103.06.VI.D
- 200.103.06.FU.D
- 200.103.06.VE.D
- 200.103.06.MA.D
- 200.103.06.NE.D
- 200.103.06.BL.D

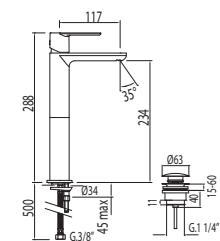

- 200.103.05.AM.D
- 200.103.05.NA.D
- 200.103.05.RO.D
- 200.103.05.VI.D
- 200.103.05.FU.D
- 200.103.05.VE.D
- 200.103.05.MA.D
- 200.103.05.NE.D
- 200.103.05.BL.D

= si veda pagina/viz ste/see page 598



Valvola SIMPLE RAPID (Allegata)
Ventil Simple Rapid (Zahrnutý)
SIMPLE RAPID valve (Included)



N

Monocomando lavabo
Umyvadlová baterie
Single lever washbasin mixer

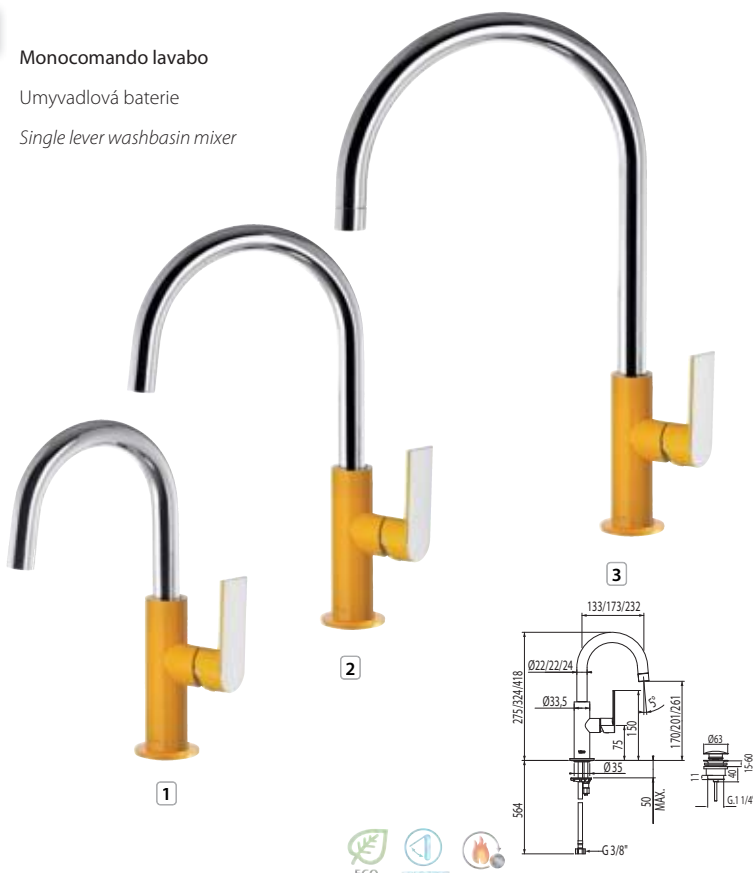

91.30.190



Ref. / Kód / Nr.:

200.205.04.AM.D
200.205.04.NA.D
200.205.04.RO.D
200.205.04.VI.D
200.205.04.FU.D
200.205.04.VE.D
200.205.04.MA.D
200.205.04.NE.D
200.205.04.BLD



91.30.190



200.205.05.AM.D
200.205.05.NA.D
200.205.05.RO.D
200.205.05.VI.D
200.205.05.FU.D
200.205.05.VE.D
200.205.05.MA.D
200.205.05.NE.D
200.205.05.BLD



91.30.190



200.205.06.AM.D
200.205.06.NA.D
200.205.06.RO.D
200.205.06.VI.D
200.205.06.FU.D
200.205.06.VE.D
200.205.06.MA.D
200.205.06.NE.D
200.205.06.BLD

N

Monocomando lavabo
canna 35x15 mm.
Umyvadlová baterie
Výtoková hubice 35x15 mm.
Single lever washbasin mixer
spout 35x15 mm.



91.30.190



200.205.01.AM.D
200.205.01.NA.D
200.205.01.RO.D
200.205.01.VI.D
200.205.01.FU.D
200.205.01.VE.D
200.205.01.MA.D
200.205.01.NE.D
200.205.01.BLD



91.30.190



200.205.02.AM.D
200.205.02.NA.D
200.205.02.RO.D
200.205.02.VI.D
200.205.02.FU.D
200.205.02.VE.D
200.205.02.MA.D
200.205.02.NE.D
200.205.02.BLD



91.30.190

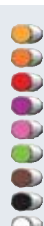

200.205.03.AM.D
200.205.03.NA.D
200.205.03.RO.D
200.205.03.VI.D
200.205.03.FU.D
200.205.03.VE.D
200.205.03.MA.D
200.205.03.NE.D
200.205.03.BLD

Ordine speciale - Tempi di consegna di 4 Settimane /
Zvláštní objednávka - Dodací lhůta 4 týdny /
Special order - Delivery time of 4 weeks

= si veda pagina/viz ste/see page 598

Valvola SIMPLE RAPID (Allegata)
Ventil Simple Rapid (Zahrnutý)
SIMPLE RAPID valve (Included)

LOFT COLORS

Bidet / Bidety / Bidets

Ref. / Kód / Nr.:

N

Monocomando bidet

Bidetová baterie

Single lever bidet mixer

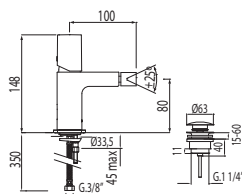

91.30.190

	200.120.02.AM.D
	200.120.02.NA.D
	200.120.02.RO.D
	200.120.02.VI.D
	200.120.02.FU.D
	200.120.02.VE.D
	200.120.02.MA.D
	200.120.02.NE.D
	200.120.02.BL.D

N

Monocomando bidet

Bidetová baterie

Single lever bidet mixer

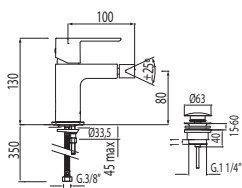

91.30.190

	200.120.01.AM.D
	200.120.01.NA.D
	200.120.01.RO.D
	200.120.01.VI.D
	200.120.01.FU.D
	200.120.01.VE.D
	200.120.01.MA.D
	200.120.01.NE.D
	200.120.01.BL.D

N

Monocomando bidet

Bidetová baterie

Single lever bidet mixer

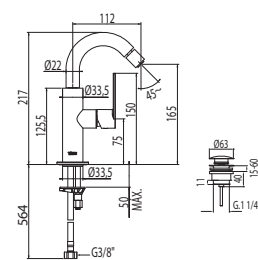

91.30.190

	200.224.01.AM.D
	200.224.01.NA.D
	200.224.01.RO.D
	200.224.01.VI.D
	200.224.01.FU.D
	200.224.01.VE.D
	200.224.01.MA.D
	200.224.01.NE.D
	200.224.01.BL.D

= si veda pagina/viz ste/see page 598



Valvola SIMPLE RAPID (Allegata)
Ventil Simple Rapid (Zahrnutý)
SIMPLE RAPID valve (Included)



Monocomandi bagno / Jednopákový mechanismus vany / Bathtub mixer taps

Ref. / Kód / Nr.:

N



Monocomando doccia
Doccia anticalcare. Flessibile satin (91.34.609.15).

Sprchová baterie

Sprchová hadice satin (91.34.609.15).

Single lever shower mixer

Shower Antilime. Shower hose satin (91.34.609.15).

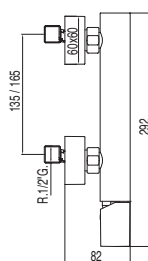

- 200.167.01.AM
- 200.167.01.NA
- 200.167.01.RO
- 200.167.01.VI
- 200.167.01.FU
- 200.167.01.VE
- 200.167.01.MA
- 200.167.01.NE
- 200.167.01.BL

N



Monocomando vasca
Con bocca a cascata. Doccia anticalcare. Flessibile satin (91.34.609.15).

Vanová baterie

S kaskádou, sprchová koncovka se systémem proti tvorbě vodního kamene. Hadice satin (91.34.609.15).

Single lever bath and shower mixer with cascade. Shower Antilime. Shower hose satin (91.34.609.15).

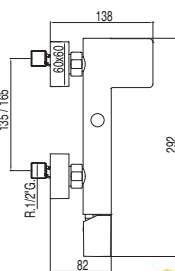

- 200.170.01.AM
- 200.170.01.NA
- 200.170.01.RO
- 200.170.01.VI
- 200.170.01.FU
- 200.170.01.VE
- 200.170.01.MA
- 200.170.01.NE
- 200.170.01.BL

Termostatiche / Termostatické / Thermostatically-controlled

Ref. / Kód / Nr.:

N



Doccia LOFT-COLORS termostatica
Doccia anticalcare. Flessibile satin (91.34.609.15).

Termostatická sprchová baterie LOFT-COLORS

Sprchová hadice satin (91.34.609.15).

Wall thermostatic shower mixer LOFT-COLORS

Shower Antilime. Shower hose satin (91.34.609.15).

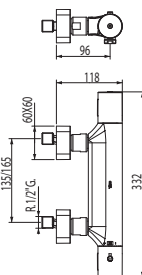

- 200.164.09.AM
- 200.164.09.NA
- 200.164.09.RO
- 200.164.09.VI
- 200.164.09.FU
- 200.164.09.VE
- 200.164.09.MA
- 200.164.09.NE
- 200.164.09.BL

N



Bagno doccia LOFT-COLORS termostatica
Con bocca a cascata. Doccia anticalcare. Flessibile satin (91.34.609.15).

Termostatická vanová a sprchová baterie LOFT-COLORS

S kaskádou, sprchová koncovka se systémem proti tvorbě vodního kamene. Hadice satin (91.34.609.15).

Wall thermostatic bath and shower mixer LOFT-COLORS with cascade. Shower Antilime. Shower hose satin (91.34.609.15).

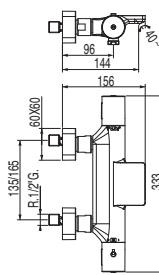

- 200.174.09.AM
- 200.174.09.NA
- 200.174.09.RO
- 200.174.09.VI
- 200.174.09.FU
- 200.174.09.VE
- 200.174.09.MA
- 200.174.09.NE
- 200.174.09.BL

Ordine speciale - Tempi di consegna di 4 Settimane /
Zvláštní objednávka - Dodací lhůta 4 týdny /
Special order - Delivery time of 4 weeks

= si veda pagina/viz ste/see page 598

LOFT COLORS

Gruppi ad incasso / Vestavěné soupravy / Built-in sets

Ref. / Kód / Nr.:

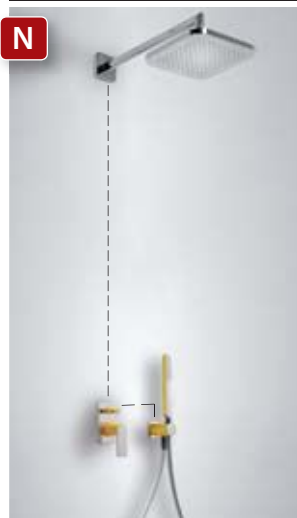

N

Kit doccia ad incasso LOFT-COLORS

Con chiusura e regolazione di portata. Doccia fissa da 220x220 mm. (299.632.06).
Supporto per doccia. Doccia anticalcarea. Flessibile satin (91.34.609.15).

Podomítkový set se sprchou LOFT-COLORS

S uzávěrem a regulací průtoku. Hlavová sprcha 220x220 mm. (299.632.06). Pevný držák s vodní přípojkou pro hadic. Sprchová koncovka se systémem proti tvorbě vodního kamene. Hadice satin (91.34.609.15).

Concealed shower set LOFT-COLORS

with water shut off and flow control. Fixed shower head 220x220 mm. (299.632.06).
Elbow wall. Antilime hand shower. Satin hose (91.34.609.15).

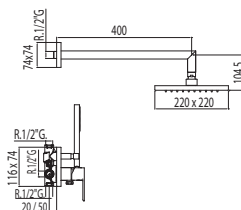

91.30.190



200.180.02.AM
200.180.02.NA
200.180.02.RO
200.180.02.VI
200.180.02.FU
200.180.02.VE
200.180.02.MA
200.180.02.NE
200.180.02.BL

Gruppi termostatici / Termostatické soupravy / Thermostatically-controlled sets

Ref. / Kód / Nr.:



N

Kit doccia termostatica LOFT-COLORS

Con chiusura e regolazione di portata. (2 vie) Doccia fissa da 220x220 mm. (299.632.06).
Supporto per doccia. Doccia anticalcarea. Flessibile satin (91.34.609.15).

Termostatický sprchový set LOFT-COLORS

S uzávěrem a regulací průtoku. (Dvoucestný) Hlavová sprcha 220x220 mm. (299.632.06).
Pevný držák s vodní přípojkou pro hadic. Sprchová koncovka se systémem proti tvorbě vodního kamene. Hadice satin (91.34.609.15).

Thermostatic bar-shower LOFT-COLORS

with water shut off and flow control. (2 ways)
Fixed shower head 220x220 mm. (299.632.06).
Elbow wall. Antilime hand shower. Satin hose (91.34.609.15).

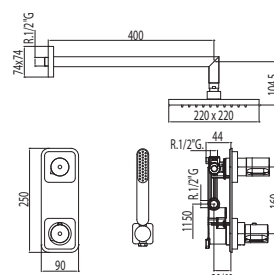

200.250.05.AM
200.250.05.NA
200.250.05.RO
200.250.05.VI
200.250.05.FU
200.250.05.VE
200.250.05.MA
200.250.05.NE
200.250.05.BL

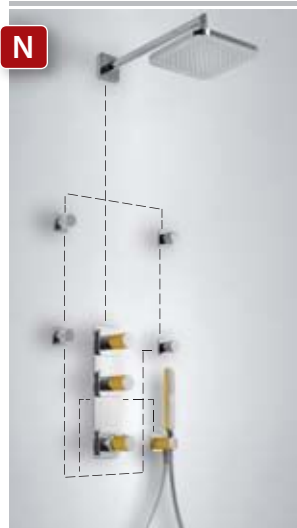

N

Kit doccia termostatica LOFT-COLORS

Con chiusura e regolazione di portata. (3 vie) Doccia fissa da 220x220 mm. (299.632.06).
Supporto per doccia. Doccia anticalcarea. Flessibile satin (91.34.609.15).

Termostatický sprchový set LOFT-COLORS

S uzávěrem a regulací průtoku. (Trojcestný)
Hlavová sprcha 220x220 mm. (299.632.06).
Pevný držák s vodní přípojkou pro hadic.
Sprchová koncovka se systémem proti tvorbě vodního kamene. Hadice satin (91.34.609.15).

Thermostatic bar-shower LOFT-COLORS

with water shut off and flow control. (3 ways)
Fixed shower head 220x220 mm. (299.632.06).
Elbow wall. Antilime hand shower. Satin hose (91.34.609.15).

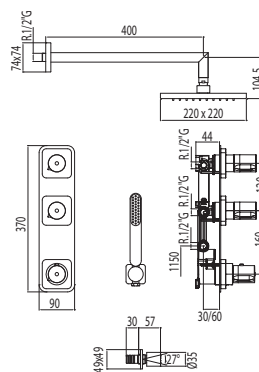

200.250.07.AM
200.250.07.NA
200.250.07.RO
200.250.07.VI
200.250.07.FU
200.250.07.VE
200.250.07.MA
200.250.07.NE
200.250.07.BL

= si veda pagina/viz ste/see page 598

Ordine speciale - Tempi di consegna di 4 Settimane /
Zvláštní objednávka - Dodací lhůta 4 týdny /
Special order - Delivery time of 4 weeks



Ref. / Kód / Nr.:

N



Set doccia LOFT-COLORS termostatica

Doccia fissa da 220x220 mm. (299.632.06). Douchette anticalcearia. Flessibile satin (91.34.609.15). Asta telescopica. Invertitore integrato nel regolatore di portata (si veda pagina 576)

Termostatický sprchový set LOFT-COLORS

Hlavová sprcha 220x220 mm. (299.632.06). Sprchová koncovka se systémem proti tvorbě vodního kamene. Hadice satin (91.34.609.15). Tyč s teleskopickou regulací výšky. Přepínač proudů integrovaný s regulátorem tlaku (viz str. 576)

Wall thermostatic shower mixer LOFT-COLORS

Fixed shower head 220x220 mm. (299.632.06). Antilime hand shower. Satin hose (91.34.609.15). Telescopic bar. Diverter integrated in the flow control (see page 576)

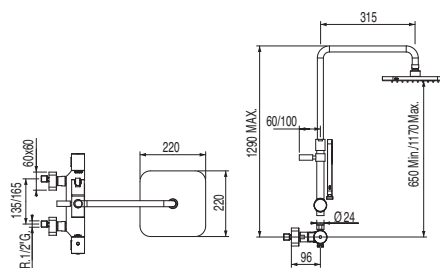

TRES TOUCH-COOL®

	200.195.01.AM
	200.195.01.NA
	200.195.01.RO
	200.195.01.VI
	200.195.01.FU
	200.195.01.VE
	200.195.01.MA
	200.195.01.NE
	200.195.01.BL



□ SLIM-TRES

202.103.01

□ SLIM-TRES



□ SLIM-TRES



202.170.01



SLIM-TRES





202.195.01

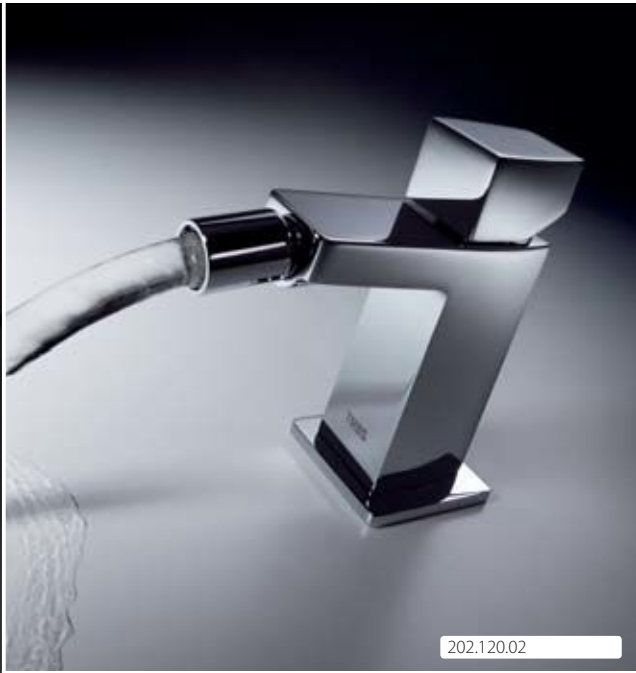

202.120.02



202.180.03



202.200.01

SLIM-TRES



202.161.01



202.250.09



202.110.02



202.167.01

SLIM-TRES



SLIM-TRES

SLIM-TRES

Lavabi monocomando / Umyvadlové baterie s jednopákovým mechanismem / Basin mixer taps

Ref. / Kód / Nr.:

N

Monocomando lavabo

Umyvadlová baterie

Single lever washbasin mixer

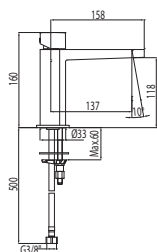
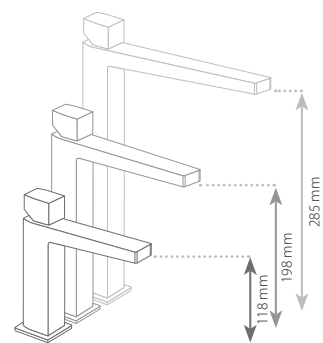

91.30.190



Cr

202.103.02

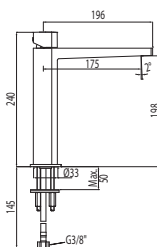

91.30.190



Cr

202.103.02.D

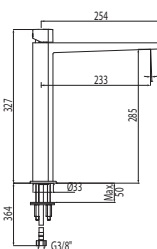

91.30.190



Cr

202.103.06



Cr = Cromo/Chrom/Chrome

Raccomandabile installare la valvola SIMPLE RAPID (non inclusa)
Doporučuje se použít ventil Simple Rapid (není v ceně)
Ideal assembly with SIMPLE RAPID valve (This is not included)

N

Monocomando lavabo

Umyvadlová baterie

Single lever washbasin mixer

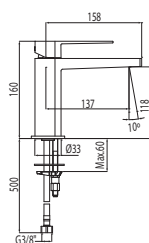

91.30.190

Cr

202.103.01



91.30.190

Cr

202.103.01.D

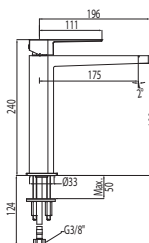

91.30.190

Cr

202.103.03

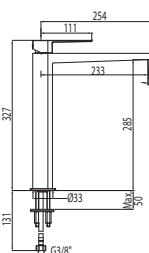

91.30.190

Cr

202.103.05



Cr = Cromo/Chrom/Chrome



Raccomandabile installare la valvola SIMPLE RAPID (non inclusa)
Doporučuje se použít ventil Simple Rapid (není v ceně)
Ideal assembly with SIMPLE RAPID valve (This is not included)

SLIM-TRES

Ref. / Kód / Nr.:

N

Monocomando lavabo con bocca a cascata aperta

Umyvadlová baterie
výtok otevřená kaskáda

Single lever washbasin mixer
with open cascade spout

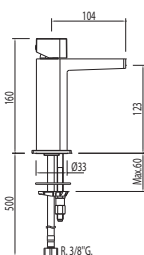

91.30.190

Cr

202.110.02

* NOTA: La rubinetteria con canna a cascata è accompagnata da 2 rubinetti di regolazione con filtro (Ref: 91.34.525)

* POZNÁMKA: Baterie typu vodopádu je doplněna dvěma regulačními kohouty s filtrem (Kód.: 91.34.525)

* NOTE: Taps with a cascade spout come with 2 regulation valves and a filter (Nr.: 91.34.525)

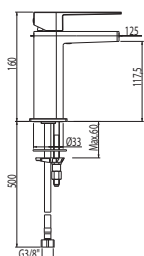

91.30.190

Cr

202.110.01

N

Monomando a muro

Nastěnná směšovací baterie

Single lever wall washbasin mixer

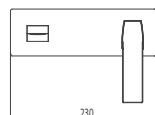
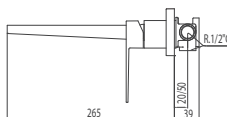

91.30.190

Cr

202.200.01



Rubinetto lavabo 1 acqua

Umyvadlová baterie pro studenou nebo smíšenou vodu

Basin pillar tap only cold water

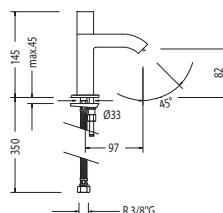

91.08.295.10

Cr

1.07.503

Bidet / Bidety / Bidets

Ref. / Kód / Nr.:



Monocomando bidet
Bidetová baterie
Single lever bidet mixer

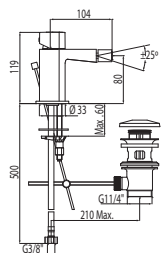

91.30.190

Cr

202.120.02



91.30.190

Cr

202.120.02.D



Monocomando bidet
Bidetová baterie
Single lever bidet mixer

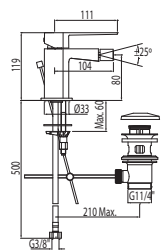

91.30.190

Cr

202.120.01



91.30.190

Cr

202.120.01.D



Monocomando bidet
Bidetová baterie
Single lever bidet mixer

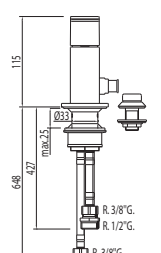

91.30.190

Cr

006.130.01



Monocomando ad incasso
per bidé WC
Záchodová baterie se
směšovačem teplot
Concealed single lever bidet/toilets

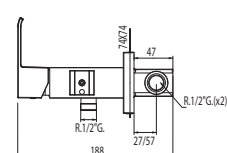

OTTONE
MOSAZ
BRASS



91.30.190

Cr

006.123.01

Cr

006.123.02 *

* Opzione Cartongesso
Možnosť pro sádkartonové panely
Optie gips

SLIM-TRES

Monocomandi bagno / Jednopákový mechanismus vany / Bathtub mixer taps

Ref. / Kód / Nr.:

N



Monocomando doccia
(Doccia anticalcarea (202.639.01). Flessibile satin (91.34.609.15)).

Sprchová baterie
(Sprchová koncovka se systémem proti tvorbě vodního kamene (202.639.01), hadice satin (91.34.609.15)).

Single lever shower mixer
(Shower Antilime (202.639.01). Shower hose satin (91.34.609.15)).

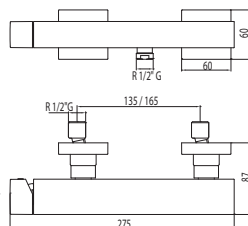

OTTONE
MOSAZ
BRASS

Cr

202.167.01

N



Monocomando vasca
(Doccia anticalcarea (202.639.01). Flessibile satin (91.34.609)).

Vanová baterie
(Sprchová koncovka se systémem proti tvorbě vodního kamene (202.639.01), hadice satin (91.34.609)).

Single lever bath and shower mixer
(Shower Antilime (202.639.01). Shower hose satin (91.34.609)).

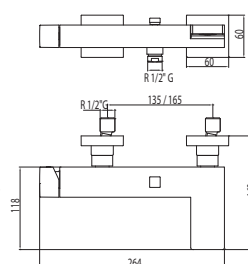

OTTONE
MOSAZ
BRASS

Cr

202.170.01

Ad incasso / Vestavěné / Built-in

Ref. / Kód / Nr.:

N



Monocomando ad incasso doccia

Podomítková sprchová baterie

Single lever concealed shower mixer

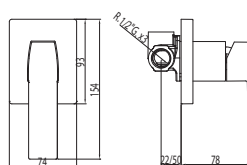

91.30.190

Cr

202.177.02



91.30.190

Cr

202.177.01

N



Monocomando incasso bagno doccia con deviatore

Podomítková vanová baterie s ruční sprchou

Single lever concealed bath and shower mixer

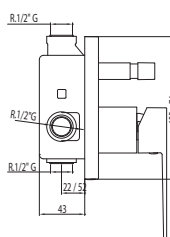

91.30.190

Cr

202.180.02



91.30.190

Cr

202.180.01

Cr = Cromo/Chrom/Chrome

N
Kit doccia ad incasso SLIM

Con chiusura e regolazione di portata. Doccia fissa da 320x220 mm. (299.632.02). Supporto per doccia. (91.06.182). Doccia anticalcarea. (202.639.01). Flessibile satin (91.34.609.15).

Podomítkový set se sprchou SLIM

S uzávěrem a regulací průtoku. Hlavová sprcha 320x220 mm. (299.632.02). Pevný držák s vodní přípojkou pro hadic. (91.06.182). Sprchová koncovka se systémem proti tvorbě vodního kamene. (202.639.01). Hadice satin (91.34.609.15).

Concealed shower set SLIM

with water shut off and flow control. Fixed shower head 320x220 mm. (299.632.02). Elbow wall. (91.06.182). Antilime hand shower. (202.639.01). Satin hose (91.34.609.15).

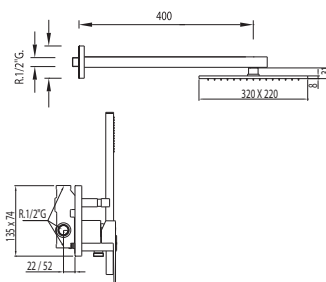
 OTTONE
MOSAZ
BRASS

 OTTONE
MOSAZ
BRASS

91.30.190

Cr

202.180.06

N
Kit doccia ad incasso SLIM

Con chiusura e regolazione di portata. Doccia acciaio inossidabile da 160x550 mm. (299.903.03). Supporto per doccia. (91.06.182). Doccia anticalcarea. (202.639.01). Flessibile satin (91.34.609.15).

Podomítkový set se sprchou SLIM

S uzávěrem a regulací průtoku. Hlavová sprcha nerezová ocel 160x550 mm. (299.903.03). Pevný držák s vodní přípojkou pro hadic. (91.06.182). Sprchová koncovka se systémem proti tvorbě vodního kamene. (202.639.01). Hadice satin (91.34.609.15).

Concealed shower set SLIM

with water shut off and flow control. Stainless steel shower 160x550 mm. (299.903.03). Elbow wall. (91.06.182). Antilime hand shower. (202.639.01). Satin hose (91.34.609.15).

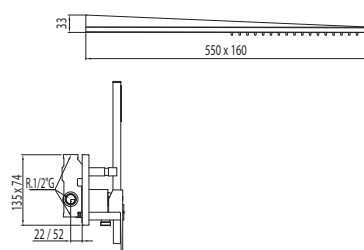
 OTTONE
MOSAZ
BRASS

91.30.190

Cr

202.180.03

N
Kit doccia ad incasso SLIM

Con chiusura e regolazione di portata. Doccia acciaio inossidabile con cascata da 140x203 mm. (299.903.04). Supporto per doccia. (91.06.182). Doccia anticalcarea. (202.639.01). Flessibile satin (91.34.609.15).

Podomítkový set se sprchou SLIM

S uzávěrem a regulací průtoku. Hlavová sprcha nerezová ocel s kaskádou 140x203 mm. (299.903.04). Pevný držák s vodní přípojkou pro hadic. (91.06.182). Sprchová koncovka se systémem proti tvorbě vodního kamene. (202.639.01). Hadice satin (91.34.609.15).

Concealed shower set SLIM

with water shut off and flow control. Stainless steel shower with cascade 140x203 mm. (299.903.04). Elbow wall. (91.06.182). Antilime hand shower. (202.639.01). Satin hose (91.34.609.15).

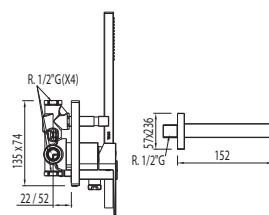
 OTTONE
MOSAZ
BRASS

91.30.190

Cr

202.180.05

SLIM-TRES

Ref. / Kód / Nr.:



N

Kit doccia ad incasso SLIM

Con chiusura e regolazione di portata. Doccia fissa 320x220 mm. (299.632.02). Asta antiscivolo lunga 900 mm. (1.34.520). Presa a parete (91.06.182). Doccia anticalcarea. (202.639.01). Flessibile satin (91.34.609.15).

Podomítkový set se sprchou SLIM

S uzávěrem a regulací průtoku. Hlavová sprcha 320x220 mm. (299.632.02). Posuvná tyč long. 900 mm. (1.34.520). Pevný držák s vodní přípojkou pro hadici (91.06.182). Sprchová koncovka se systémem proti tvorbě vodního kamene. (202.639.01). Hadice satin (91.34.609.15).

Concealed shower set SLIM

with water shut off and flow control. Fixed shower head 320x220 mm. (299.632.02). Sliding bar long. 900 mm. (1.34.520). Elbow wall (91.06.182). Antilime hand shower. (202.639.01). Satin hose (91.34.609.15).

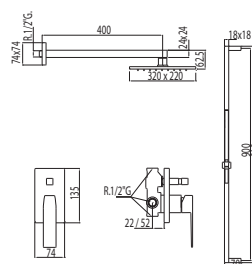

OTTONE
MOSAZ
BRASS



OTTONE
MOSAZ
BRASS



91.30.190

Cr

202.180.07



N

Kit doccia ad incasso SLIM

Con chiusura e regolazione di portata. Doccia acciaio inossidabile con cascata 280x550 mm. 2 funzioni. (299.903.01).

Podomítkový set se sprchou SLIM

S uzávěrem a regulací průtoku. Hlavová sprcha nerezová ocel S kaskádou 280x550 mm. 2 proudy. (299.903.01).

Concealed shower set SLIM

with water shut off and flow control. Stainless steel shower with cascade 280x550 mm. 2 positions (299.903.01).

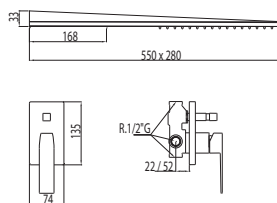

91.30.190

Cr

202.180.08

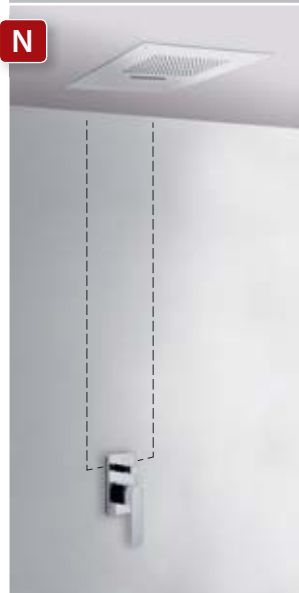

N

Kit doccia acciaio inossidabile ad incasso SLIM

Con chiusura e regolazione di portata. Doccia con cascata 500x500 mm. 2 funzioni (299.516.02)

Podomítkový set Kartáčovaná ocel sprchou SLIM

S uzávěrem a regulací průtoku. Hlavová sprcha S kaskádou 500x500 mm. 2 proudy (299.516.02)

Concealed shower set SLIM

with water shut off and flow control. Stainless steel shower with cascade 500x500 mm. 2 positions (299.516.02)

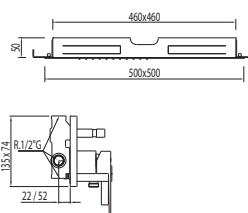

91.30.190

Cr

202.180.09

Cr = Cromo/Chrom/Chrome

Bordovasca / Vany s prodlouženým pultem / Deck-mounted bathtubs

Ref. / Kód / Nr.:

N
**Monocomando bordo vasca
con doccia anticalcarea (202.639.01)**

Vanová 3-otvorová stojánková baterie s progresivním regulátorem

S sprchová koncovka se systémem proti tvorbě vodního kamene (202.639.01)

*Bath-shower single lever tap for bracket shelf
with shower antilime (202.639.01)*

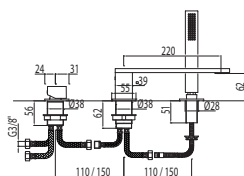
 °C
3 bar
13 l/m

91.30.190

Cr

202.161.02

 OTTONE
MOSAZ
BRASS

91.30.190

Cr

202.161.01

 OTTONE
MOSAZ
BRASS

N
**Monocomando bordo vasca
Con bocca a cascata, doccia anticalcare (202.639.01).**

Vanová 3-otvorová stojánková baterie s progresivním regulátorem

S přívalovým vtokem, ruční sprchy se systémem proti vzniku vodního kamene (202.639.01).

*Bath-shower single lever tap for bracket shelf
with cascade cast spout and antilime
hand shower (202.639.01).*

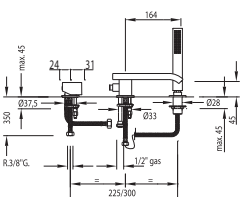
 °C
3 bar
13 l/m

91.30.190

Cr

202.661.02

 OTTONE
MOSAZ
BRASS

91.30.190

Cr

202.661.01

 OTTONE
MOSAZ
BRASS

N
**Kit bordo vasca
Facile montaggio superiore. Senza registro**

Montážní sada k 3-otvorové baterii s odtokem zbytků vody

Snadná montáž/demontáž seshora. Není nutné montovat dodatečné revizní prvky u vany

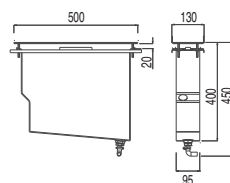
*Bath-shower kit cistern
easy upper assembly, without installation*

 Brevettato®
Patentovaný®
Patented®

Cr

202.245.01
Valvola vasca con presa drenaggio

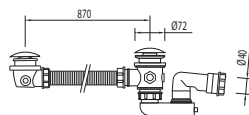
Vanový sifon typu click-clack s přípojkou k odtokovému systému 3-otvorové baterie

Bath valve with drainage point

Cr

1.34.445

SLIM-TRES

Termostatiche / Termostatické / Thermostatically-controlled

Ref. / Kód / Nr.:



Doccia SLIM termostatica
 Doccia anticalcarea. Flessibile satin (91.34.609.15).

Termostatická sprchová baterie SLIM
 Sprchová hadice satin (91.34.609.15).

Wall thermostatic shower mixer SLIM

Shower Antilime. Shower hose satin (91.34.609.15).



TRES TOUCH-COOL®

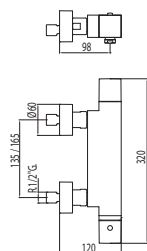

Cr

1.07.164



N

Cr

202.164.09



OTTONE
 MOSAZ
 BRASS



Vasca-Doccia SLIM termostatica
 Con bocca a cascata. Doccia anticalcarea. Flessibile satin (91.34.609).

Termostatická vanová a sprchová baterie SLIM
 S kaskádou, sprchová hadice satin (91.34.609).

Wall thermostatic bath and shower mixer SLIM

with cascade. Shower Antilime. Satin hose (91.34.609).



TRES TOUCH-COOL®

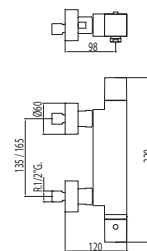

Cr

1.07.174



N

Cr

202.174.09



OTTONE
 MOSAZ
 BRASS

N



Gomito adattore bagno-doccia

Koleno k vanové baterii

Bath and shower adaptable column

con silenziatore
 do zdi s gumovými tlumiči
 with silencer

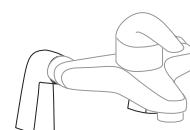
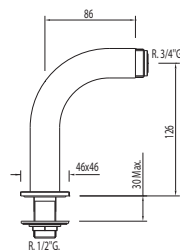

Cr

299.870.02

Gruppi termostatici / Termostatické soupravy / Thermostatically-controlled sets

Ref. / Kód / Nr.:

N



Set doccia SLIM termostatica

Doccia fissa da 320x220 mm. Ottone (299.632.02). Doccia anticalcare (202.639.01). Flessibile satin (91.34.609.15). Invertitore integrato nel regolatore di portata (si veda pagina 576)

Termostatický sprchový set SLIM

Hlavová sprcha 320x220 mm. Mosaz (299.632.02). Sprchová koncovka se systémem proti tvorbě vodního kamene (202.639.01), hadice satin (91.34.609.15). Přepínač proudů integrovaný s regulátorem tlaku (viz str. 576)

Wall thermostatic shower mixer SLIM

Fixed shower head 320x220 mm. Brass (299.632.02). Antilime hand shower (202.639.01) and satin hose (91.34.609.15). Diverter integrated in the flow control (see page 576)



TRES TOUCH-COOL®

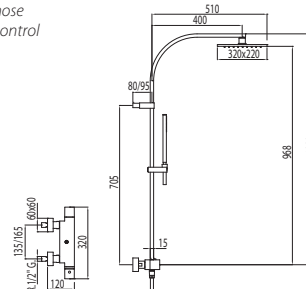

OTTONE
 MOSAZ
 BRASS



OTTONE
 MOSAZ
 BRASS

Cr

202.195.01

Cr = Cromo/Chrom/Chrome



N

Kit doccia termostatica SLIM-CUADRO

Con chiusura e regolazione di portata. (2 vie) Doccia acciaio inossidabile con cascata 280x550 mm. 2 funzioni (299.903.01)

Termostatický sprchový set SLIM-CUADRO

S uzávěrem a regulací průtoku. (Dvoucestný) Hlavová sprcha nerezová ocel S kaskádou 280x550 mm. 2 proudy (299.903.01)

Thermostatic bar-shower SLIM-CUADRO

with water shut off and flow control. (2 ways) Stainless steel shower with cascade 280x550 mm. 2 positions (299.903.01)

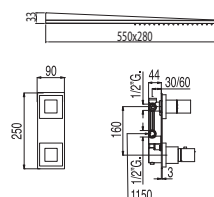

Cr 202.865.01



Kit doccia termostatica SLIM-CUADRO

Con chiusura e regolazione di portata. (2 vie) Doccia acciaio inossidabile con cascata 500x500 mm. 2 funzioni (299.516.02)

Termostatický sprchový set SLIM-CUADRO

S uzávěrem a regulací průtoku. (Dvoucestný) Hlavová sprcha nerezová ocel S kaskádou 500x500 mm. 2 proudy (299.516.02)

Thermostatic bar-shower SLIM-CUADRO

with water shut off and flow control. (2 ways) Stainless steel shower with cascade 500x500 mm. 2 positions (299.516.02)

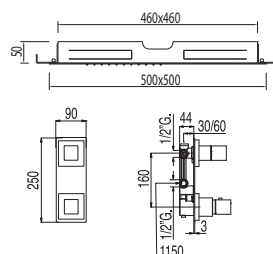

Cr 007.865.01



N

Kit doccia termostatica SLIM

Con chiusura e regolazione di portata. (2 vie) Doccia fissa da 320x220 mm. (299.632.02). Ottone. Supporto per doccia. (91.06.182). Doccia anticalcarea. (202.639.01). Flessibile satin (91.34.609.15).

Termostatický sprchový set SLIM

S uzávěrem a regulací průtoku. (Dvoucestný) Hlavová sprcha 320x220 mm. (299.632.02).

Mosaz. Pevný držák s vodní přípojkou pro hadic. (91.06.182). Sprchová koncovka se systémem proti tvorbě vodního kamene. (202.639.01). Hadice satin (91.34.609.15).

Thermostatic bar-shower SLIM

with water shut off and flow control. (2 ways) Fixed shower head 320x220 mm. (299.632.02). Brass. Elbow wall. (91.06.182). Antilime hand shower. (202.639.01). Satin hose (91.34.609.15).

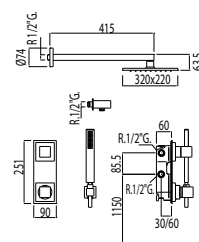

Cr 202.175.01



OTTONE
MOSAZ
BRASS



OTTONE
MOSAZ
BRASS



N

Kit doccia termostatica SLIM

Con chiusura e regolazione di portata. (3 vie) Doccia acciaio inossidabile da 210x550 mm. (299.903.02). Supporto per doccia. (91.06.182). Doccia anticalcarea. (202.639.01). Flessibile satin (91.34.609.15).

Termostatický sprchový set SLIM

S uzávěrem a regulací průtoku. (Trojcestný) Hlavová sprcha nerezová ocel 210x550 mm. (299.903.02). Pevný držák s vodní přípojkou pro hadic. (91.06.182). Sprchová koncovka se systémem proti tvorbě vodního kamene. (202.639.01). Hadice satin (91.34.609.15).

Thermostatic bar-shower SLIM

with water shut off and flow control. (3 ways) Stainless steel shower 210x550 mm. (299.903.02). Elbow wall. (91.06.182). Antilime hand shower. (202.639.01). Satin hose (91.34.609.15).

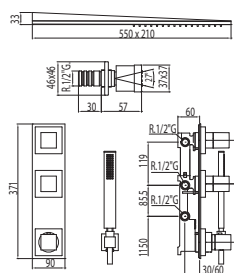

OTTONE
MOSAZ
BRASS

Cr 202.867.01



N

Kit doccia termostatica SLIM

Con chiusura e regolazione di portata. (4 vie) Doccia acciaio inossidabile con cascata 280x550 mm. 2 funzioni (299.903.01). Supporto per doccia. (91.06.182). Doccia anticalcarea. (202.639.01). Flessibile satin (91.34.609.15).

Termostatický sprchový set SLIM

S uzávěrem a regulací průtoku. (Čtyřcestný) Hlavová sprcha nerezová ocel S kaskádou 280x550 mm. 2 proudy (299.903.01). Pevný držák s vodní přípojkou pro hadic. (91.06.182). Sprchová koncovka se systémem proti tvorbě vodního kamene. (202.639.01). Hadice satin (91.34.609.15).

Thermostatic bar-shower SLIM

with water shut off and flow control. (3 ways) Stainless steel shower with cascade 280x550 mm. 2 positions (299.903.01). Elbow wall. (91.06.182). Antilime hand shower. (202.639.01). Satin hose (91.34.609.15).

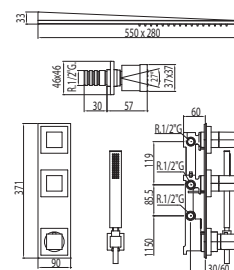

OTTONE
MOSAZ
BRASS

Cr 202.250.09



N

Kit doccia termostatica SLIM

Con chiusura e regolazione di portata. (3 vie) Doccia acciaio inossidabile con cascata 500x500 mm. 2 funzioni (299.516.02). Supporto per doccia. (91.06.182). Doccia anticalcarea. (202.639.01). Flessibile satin (91.34.609.15).

Termostatický sprchový set SLIM

S uzávěrem a regulací průtoku. (Trojcestný) Hlavová sprcha nerezová ocel S kaskádou 500x500 mm. 2 proudy (299.516.02). Pevný držák s vodní přípojkou pro hadic. (91.06.182). Sprchová koncovka se systémem proti tvorbě vodního kamene. (202.639.01). Hadice satin (91.34.609.15).

Thermostatic bar-shower SLIM

with water shut off and flow control. (3 ways) Stainless steel shower with cascade 500x500 mm. 2 positions (299.516.02). Elbow wall. (91.06.182). Antilime hand shower. (202.639.01). Satin hose (91.34.609.15).

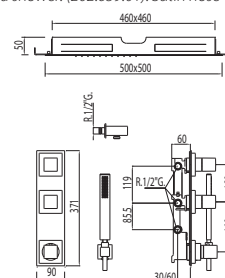

OTTONE
MOSAZ
BRASS

Cr 202.866.02

SLIM-TRES

Ref. / Kód / Nr.:

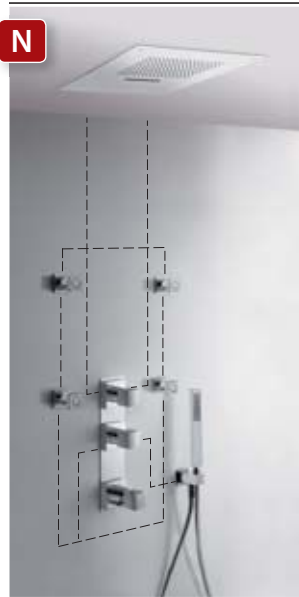

N

Kit doccia termostatica SLIM

Con chiusura e regolazione di portata. (4 vie) Doccia acciaio inossidabile con cascata 500x500 mm. 2 funzioni (299.516.02). Supporto per doccia. (91.06.182). Doccia anticalcarea. (202.639.01). Flessibile satin (91.34.609.15).

Termostatický sprchový set SLIM

S uzavěrem a regulací průtoku. (Čtyřcestný) Hlavová sprcha nerezová ocel s kaskádou 500x500 mm. 2 proudy (299.516.02). Pevný držák s vodní přípojkou pro hadic. (91.06.182). Sprchová koncovka se systémem proti tvorbě vodního kamene. (202.639.01). Hadice satin (91.34.609.15).

Thermostatic bar-shower SLIM

with water shut off and flow control. (3 ways) Stainless steel shower with cascade 500x500 mm. 2 positions (299.516.02). Elbow wall. (91.06.182). Antilime hand shower. (202.639.01). Satin hose (91.34.609.15).

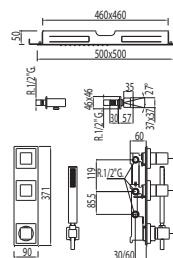

OTTONE
MOSAZ
BRASS



Cr 202.867.02



N

Batteria vasca termostatica SLIM

Con bocca a cascata. Supporto per doccia. (91.06.182). Doccia anticalcarea. (202.639.01). Flessibile satin (91.34.609.15).

Termostatická podomítková vanová baterie se sprchou

S přívalem vtokem. Pevný držák s vodní přípojkou pro hadic. (91.06.182). Sprchová koncovka se systémem proti tvorbě vodního kamene. (202.639.01). Hadice satin (91.34.609.15).

Thermostatic bath SLIM

with cascade cast spout. Elbow wall. (91.06.182). Antilime hand shower. (202.639.01). Satin hose (91.34.609.15).

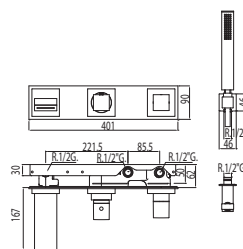

OTTONE
MOSAZ
BRASS



TRES BLOCK-SYSTEM®

Cr 202.250.10



Bocca a cascata set doccia

Přívalem přítokem vanový set

Cascade cast spout bath mixer

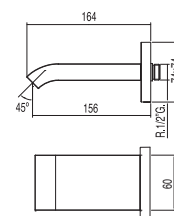

Cr 1.07.181
Ac 5.07.181.03

SLIM-TRES

Rubinetti di arresto / Průchozí ventily / Shutoff valves

Ref. / Kód / Nr.:



Rubinetto di arresto filettato 1/2"

Ventil se závitem 1/2"

1/2" threaded-ends gate-valve

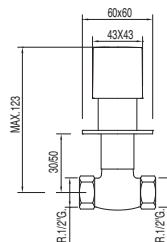

Cr 1.07.155



Rubinetto di arresto filettato 3/4"

Ventil se závitem 3/4"

3/4" threaded-ends gate-valve

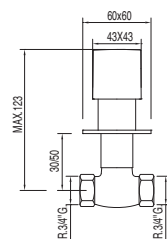

Cr 1.07.511

Ricambi / Náhradní díly / Spare parts



Manopola

Úchyt
Lever

Cr 299.083.10

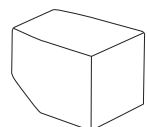

Volano

Otočný ovladač
Handle

Cr 299.082.10

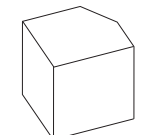

Volano Lato portata

Otočný ovladač na straně
regulace proudu vody
Handle Flow side

(per ref. / Kód / for Nr.: 07.164, 07.174,
202.195.01, 202.164.09, 202.174.09)
Cr 91.94.006.02

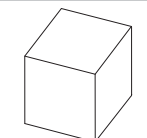

Volano Lato portata

Otočný ovladač na straně
regulace proudu vody
Handle Flow side

(per ref. / Kód / for Nr.: 202.195.01)
Cr 91.94.006.20

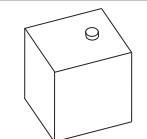

Manopola lato
temperatura

Kohoutek na straně
s regulací teploty
Temperature side handle

(per ref. / Kód / for Nr.: 07.164, 07.174,
202.195.01, 202.164.09, 202.174.09)
Cr 91.94.006.01



Cartuccia termostatica
+ volano

Termostatická vložka s
otočným ovládačem
Thermostatic cartridge
stem + Handle

(per ref. / Kód / for Nr.: 07.164, 07.174,
202.195.01, 202.164.09, 202.174.09)
Cr 91.06.161.01

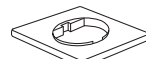

Base lavabo

Ozdobný kroužek pod
umyvadlovou baterii
Mixer base

Cr 299.081.01



Rotula

Bidetové klouby
Ball-and-socket joint
bidet mixer

Cr 91.07.672

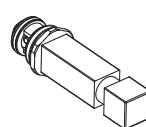

Invertitore

Přepínač
Diverter

(per ref. / Kód / for Nr.: 202.180.01,
202.180.02)
Cr 91.06.180.20

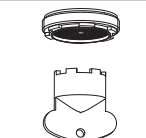

Rompigetto occulto +
rubinetto

Skrytý filtr proti
postříkání + klíč
Hidden water breaker
+ key

M. 24
Cr 91.34.668

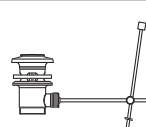

Scarico automatico

Automatický odtok
Pop-up waste

1,1/4"

Cr 91.34.375.10

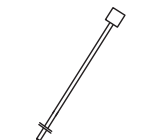

Set asta e pulsante

Sada přepínače s
vedením a úchytém
Button and rod set

Cr 91.34.375

Cr = Cromo/Chrom/Chrome



1.06.108

□ CUADRO-TRES

CUADRO-TRES





1.07.395



1.06.603



1.06.260



1.07.107.03

□ CUADRO-TRES

□ CUADRO-TRES





1.06.161.02 + 1.06.245



1.07.170.02.60

CUADRO-TRES

ALTEZZA DI COMFORT / RŮZNÁ VÝŠKA / COMFORT HEIGHT

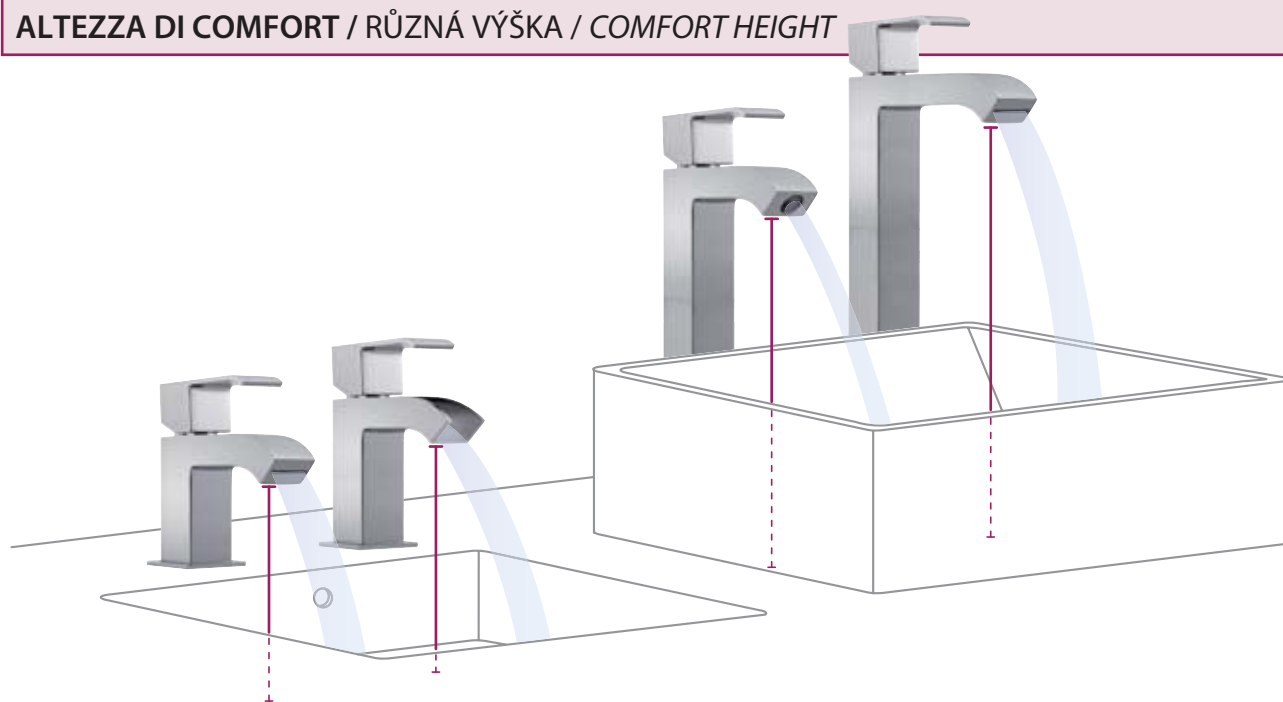

Ampia gamma di prodotti con diverse altezze per una maggiore comodità al fine di soddisfare tutte le esigenze di design.

Široká škála výrobků s různou výškou, jež uspokojí jakékoli nároky na pohodlí a design.

Wide range of products with different comfort heights to meet all design needs



□ CUADRO-TRES

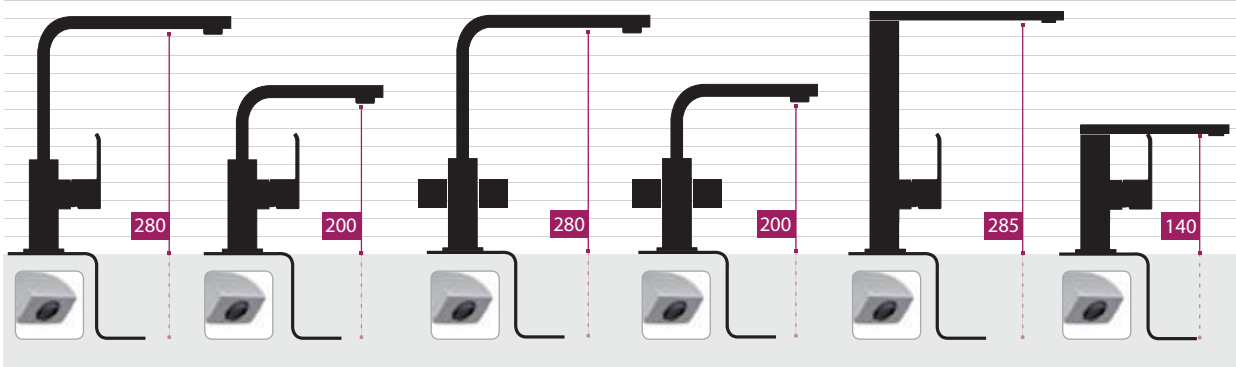
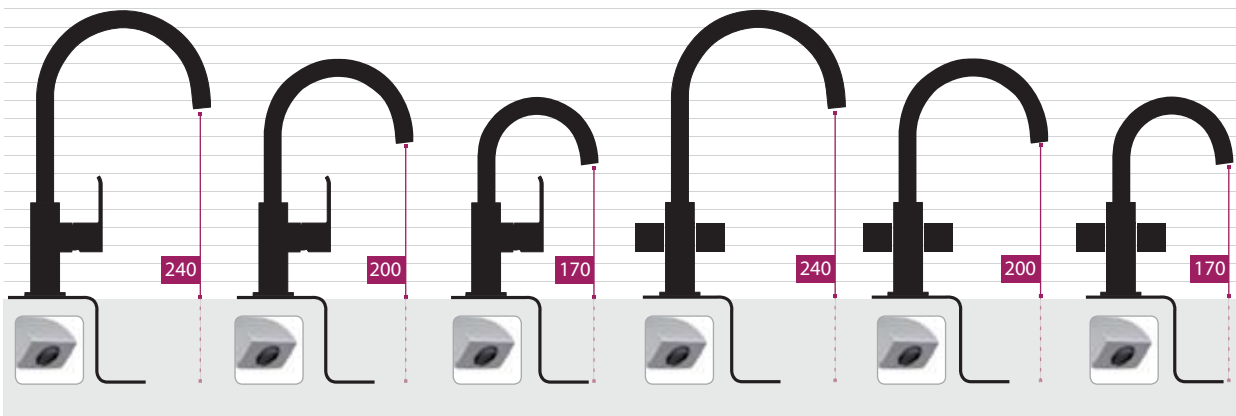
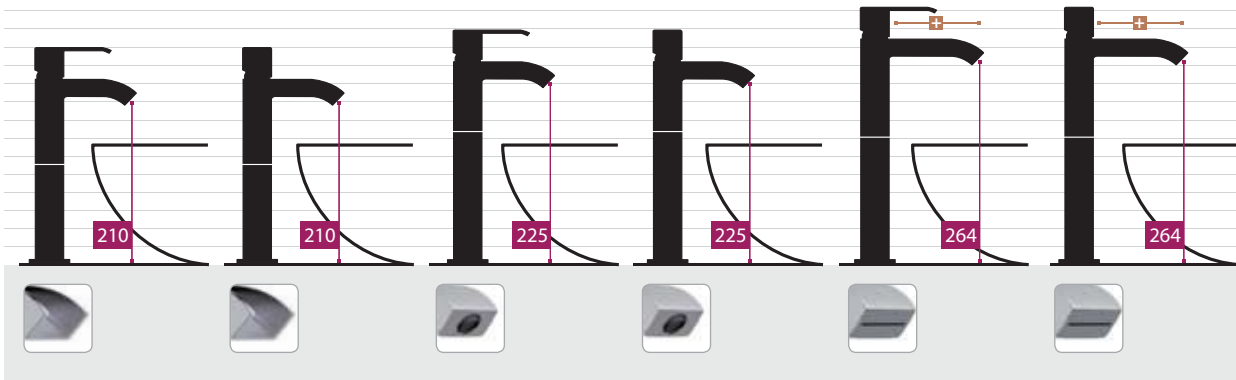
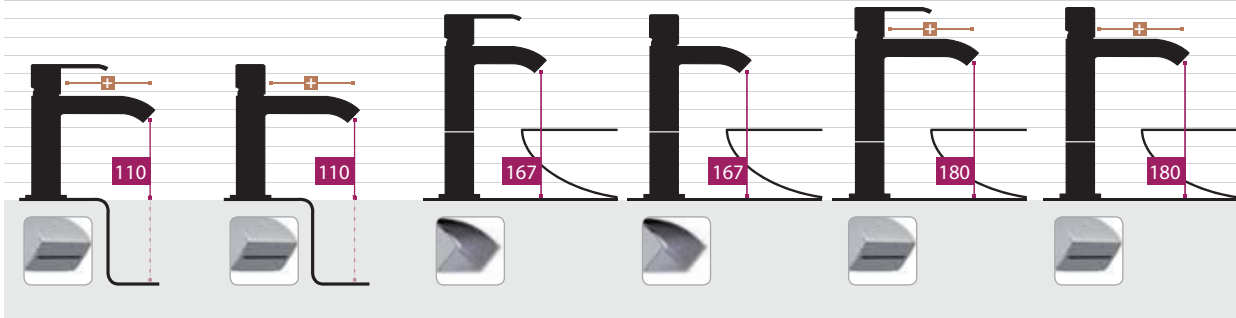
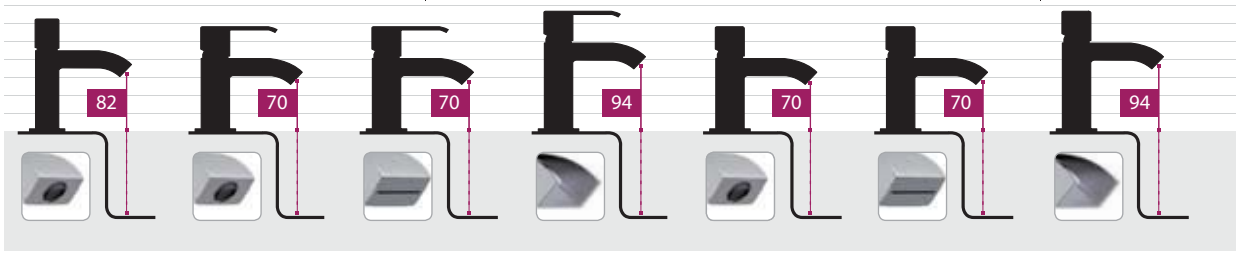

□ CUADRO-TRES

CUADRO-TRES



Lavabi monocomando / Umyvadlové baterie s jednopákovým mechanismem / Basin mixer taps

Ref. / Kód / Nr.:

Monocomando lavabo

Umyvadlová baterie

Single lever washbasin mixer

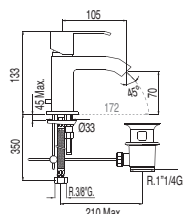
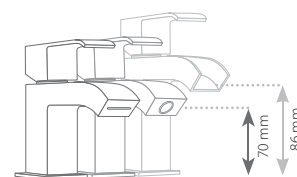

Cr	1.06.103.02
Ac	5.06.103.02.03



Cr	1.06.103.02.DA
Ac	5.06.103.02.03.DA

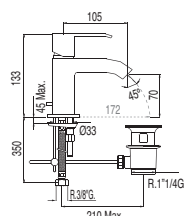

Cr	1.06.103
----	----------



Cr	1.06.103.DA
----	-------------

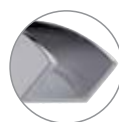
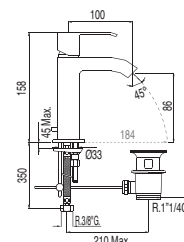

Cr	1.06.103.03
----	-------------



Cr	1.06.103.03.DA
----	----------------

* NOTA: La rubinetteria con canna a cascata è accompagnata da 2 rubinetti di regolazione con filtro (Ref: 91.34.525)

* POZNÁMKA: Baterie typu vodopádu je doplněna dvěma regulačními kohouty s filtrem (Kód: 91.34.525)

* NOTE: Taps with a cascade spout come with 2 regulation valves and a filter (Nr.: 91.34.525)

Cr = Cromo/Chrom/Chrome Ac = Acciaio/Kartáčovaná ocel/Steel

 Raccomandabile installare la valvola SIMPLE RAPID (non inclusa)
Doporučuje se použít ventil Simple Rapid (není v ceně)
Ideal assembly with SIMPLE RAPID valve (This is not included)



Ref. / Kód / Nr.:

Monocomando lavabo con prolunga inferiore con bocca a cascata aperta

Umyvadlová baterie s prodlužkou výtok otevřená kaskáda

Single lever washbasin mixer with open cascade spout

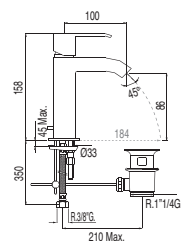

91.30.190

Cr

1.06.103.03



91.30.190

Cr

1.06.103.03.DA

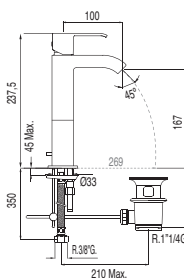

91.30.190

Cr

1.06.117.03



91.30.190

Cr

1.06.117.03.DA

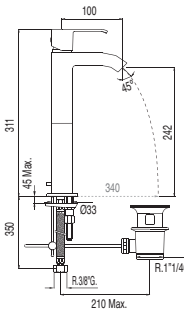

91.30.190

Cr

1.06.107.03



91.30.190

Cr

1.06.107.03.DA

*** NOTA:** La rubinetteria con canna a cascata è accompagnata da 2 rubinetti di regolazione con filtro (Ref: 91.34.525)

*** POZNÁMKA:** Baterie typu vodopádu je doplněna dvěma regulačními kohouty s filtrem (Kód.: 91.34.525)

*** NOTE:** Taps with a cascade spout come with 2 regulation valves and a filter (Nr.: 91.34.525)

Cr = Cromo/Chrom/Chrome

 Raccomandabile installare la valvola SIMPLE RAPID (non inclusa)
Doporučuje se použít ventil Simple Rapid (není v ceně)
Ideal assembly with SIMPLE RAPID valve (This is not included)

CUADRO-TRES



Ref. / Kód / Nr.:

MISURE SPECIALI / NESTANDARDNÍ ROZMERY / EXCEPTIONAL MEASURES

Monocomando lavabo con prolunga inferiore

con bocca a cascata

Umyvadlová baterie s prodlužkou s přívalovým přítokem

Single lever washbasin mixer with cascade cast spout

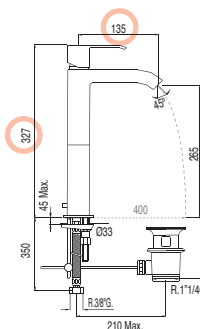
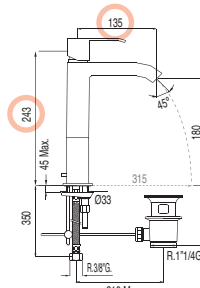
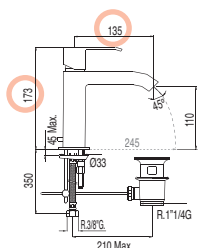
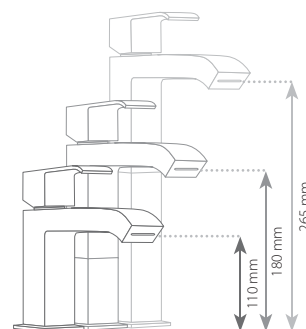
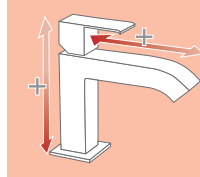

* NOTA: La rubinetteria con canna a cascata è accompagnata da 2 rubinetti di regolazione con filtro (Ref: 91.34.525)

* POZNÁMKA: Baterie typu vodopádu je doplněna dvěma regulačními kohouty s filtrem (Kód.: 91.34.525)

* NOTE: Taps with a cascade spout come with 2 regulation valves and a filter (Nr.: 91.34.525)



91.30.190



Cr

1.06.108



91.30.190



Cr

1.06.108.DA



91.30.190



Cr

1.06.118



91.30.190



Cr

1.06.118.DA



91.30.190



Cr

1.06.208



91.30.190



Cr

1.06.208.DA

Cr = Cromo/Chrom/Chrome



Raccomandabile installare la valvola SIMPLE RAPID (non inclusa)
Doporučuje se použít ventil Simple Rapid (není v ceně)
Ideal assembly with SIMPLE RAPID valve (This is not included)

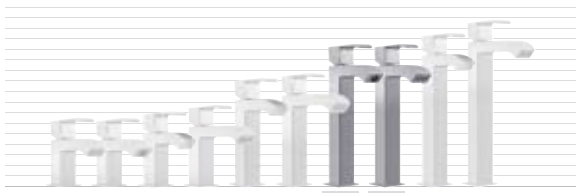

Ref. / Kód / Nr.:



Monocomando lavabo con prolunga inferiore

Umyvadlová baterie s prodlužkou

Single lever washbasin mixer

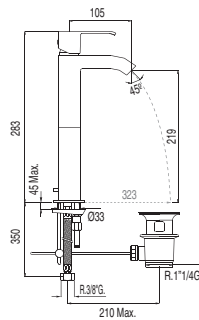
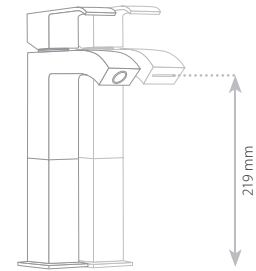

*** NOTA:** La rubinetteria con canna a cascata è accompagnata da 2 rubinetti di regolazione con filtro (Ref: 91.34.525)

*** POZNÁMKA:** Baterie typu vodopádu je doplněna dvěma regulačními kohouty s filtrem (Kód.: 91.34.525)

*** NOTE:** Taps with a cascade spout come with 2 regulation valves and a filter (Nr.: 91.34.525)



91.30.190

Cr

1.06.107



91.30.190

Cr

1.06.107.DA



91.30.190

Cr

1.06.107.02



91.30.190

Cr

1.06.107.02.DA



CUADRO-TRES

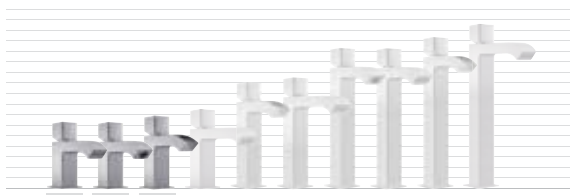

Ref. / Kód / Nr.:

Monocomando lavabo

Umyvadlová baterie

Single lever washbasin mixer

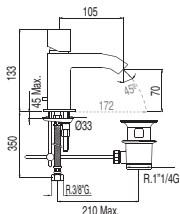
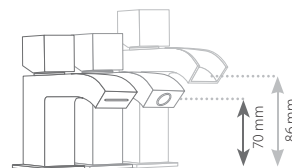

Cr	1.07.103.02
Ac	5.07.103.02.03



Cr	1.07.103.02.DA
Nog	1.07.103.02.60.DA
Ac	5.07.103.02.03.DA

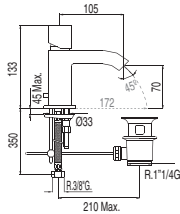

Cr	1.07.103
----	----------



Cr	1.07.103.DA
----	-------------

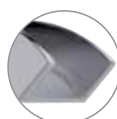
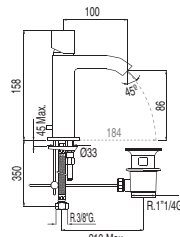

Cr	1.07.103.03
----	-------------



Cr	1.07.103.03.DA
Nog	1.07.103.03.60.DA

* NOTA: La rubinetteria con canna a cascata è accompagnata da 2 rubinetti di regolazione con filtro (Ref: 91.34.525)

* POZNÁMKA: Baterie typu vodopádu je doplněna dvěma regulačními kohouty s filtrem (Kód: 91.34.525)

* NOTE: Taps with a cascade spout come with 2 regulation valves and a filter (Nr.: 91.34.525)

Cr = Cromo/Chrom/Chrome Nog = Noce/Ořech/Walnut Ac = Acciaio/Kartáčovaná ocel/Steel

 Raccomandabile installare la valvola SIMPLE RAPID (non inclusa)
Doporučuje se použít ventil Simple Rapid (není v ceně)
Ideal assembly with SIMPLE RAPID valve (This is not included)

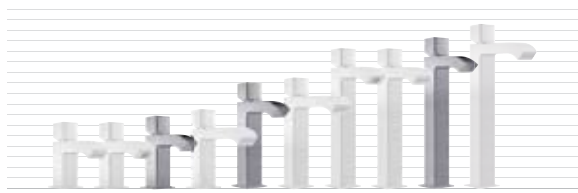

Ref. / Kód / Nr.:

Monocomando lavabo con prolunga inferiore

con bocca a cascata aperta

Umyvadlová baterie s prodlužkou

výtok otevřená kaskáda

Single lever washbasin mixer

with open cascade spout

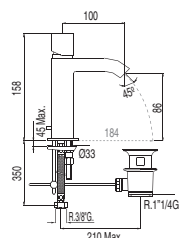

91.30.190

Cr

1.07.103.03



91.30.190

Cr

1.07.103.03.DA
1.07.103.03.60.DA

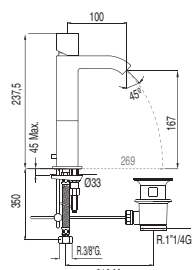

91.30.190

Cr

1.07.117.03



91.30.190

Cr

1.07.117.03.DA

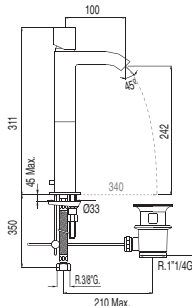

91.30.190

Cr

1.07.107.03



91.30.190

Cr

1.07.107.03.DA

* NOTA: La rubinetteria con canna a cascata è accompagnata da 2 rubinetti di regolazione con filtro (Ref: 91.34.525)

* POZNÁMKA: Baterie typu vodopádu je doplněna dvěma regulačními kohouty s filtrem (Kód.: 91.34.525)

* NOTE: Taps with a cascade spout come with 2 regulation valves and a filter (Nr.: 91.34.525)

Cr = Cromo/Chrom/Chrome Nog = Noce/Ořech/Walnut

 Raccomandabile installare la valvola SIMPLE RAPID (non inclusa)
Doporučuje se použít ventil Simple Rapid (není v ceně)
Ideal assembly with SIMPLE RAPID valve (This is not included)

CUADRO-TRES



Ref. / Kód / Nr.:

MISURE SPECIALI / NESTANDARDNÍ ROZMERY / EXCEPTIONAL MEASURES

Monocomando lavabo con prolunga inferiore

con bocca a cascata

Umyvadlová baterie s prodlužkou s přívalovým přítokem

Single lever washbasin mixer with cascade cast spout

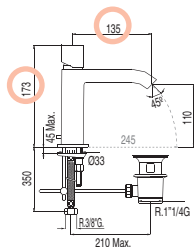
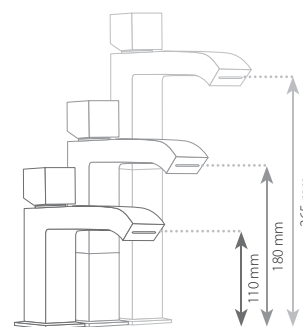
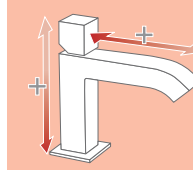

91.30.190



Cr

1.07.108

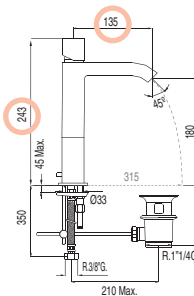

91.30.190



Cr

1.07.108.DA

Nog

1.07.108.60.DA

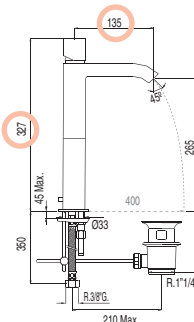

91.30.190



Cr

1.07.118



91.30.190



Cr

1.07.208



91.30.190



Cr

1.07.208.DA

* NOTA: La rubinetteria con canna a cascata è accompagnata da 2 rubinetti di regolazione con filtro (Ref: 91.34.525)

* POZNÁMKA: Baterie typu vodopádu je doplněna dvěma regulačními kohouty s filtrem (Kód: 91.34.525)

* NOTE: Taps with a cascade spout come with 2 regulation valves and a filter (Nr.: 91.34.525)

Cr = Cromo/Chrom/Chrome Nog = Noce/Ořech/Walnut

 Raccomandabile installare la valvola SIMPLE RAPID (non inclusa)
Doporučuje se použít ventil Simple Rapid (není v ceně)
Ideal assembly with SIMPLE RAPID valve (This is not included)

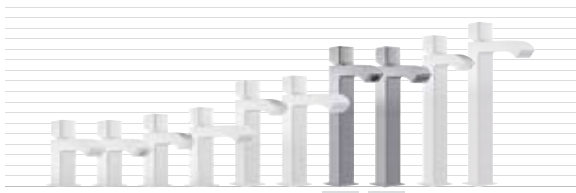

Ref. / Kód / Nr.:

Monocomando lavabo con prolunga inferiore

Umyvadlová baterie s prodlužkou

Single lever washbasin mixer

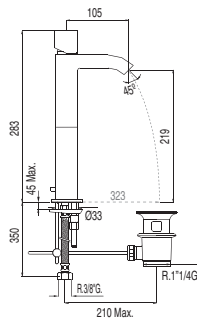
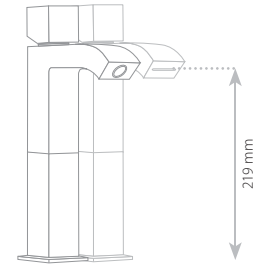

*** NOTA: La rubinetteria con canna a cascata è accompagnata da 2 rubinetti di regolazione con filtro (Ref: 91.34.525)**

*** POZNÁMKA: Baterie typu vodopádu je doplněna dvěma regulačními kohouty s filtrem (Kód: 91.34.525)**

*** NOTE: Taps with a cascade spout come with 2 regulation valves and a filter (Nr.: 91.34.525)**



91.30.190

Cr

1.07.107



91.30.190

Cr

1.07.107.DA

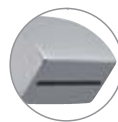

91.30.190

Cr

1.07.107.02



91.30.190

Cr

1.07.107.02.DA

CUADRO-TRES

Ref. / Kód / Nr.:

Monocomando lavabo
 canna 22x22 mm.
 Umyvadlová baterie
 výtoková hubice 22x22 mm.
 Single lever washbasin mixer
 spout 22x22 mm.

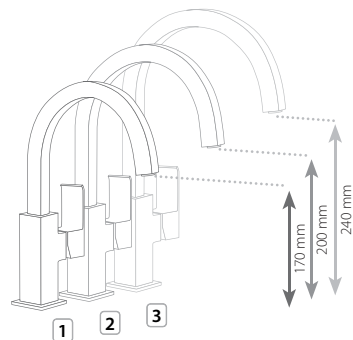

1		91.30.190	Cr	1.06.605	
2		91.30.190	Cr	1.06.606	
3		91.30.190	Cr	1.06.607	

Monocomando lavabo
 canna 35x15 mm.
 Umyvadlová baterie
 Výtoková hubice 35x15 mm.
 Single lever washbasin mixer
 spout 35x15 mm.

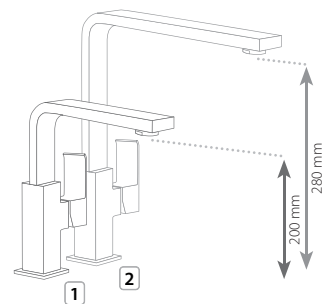
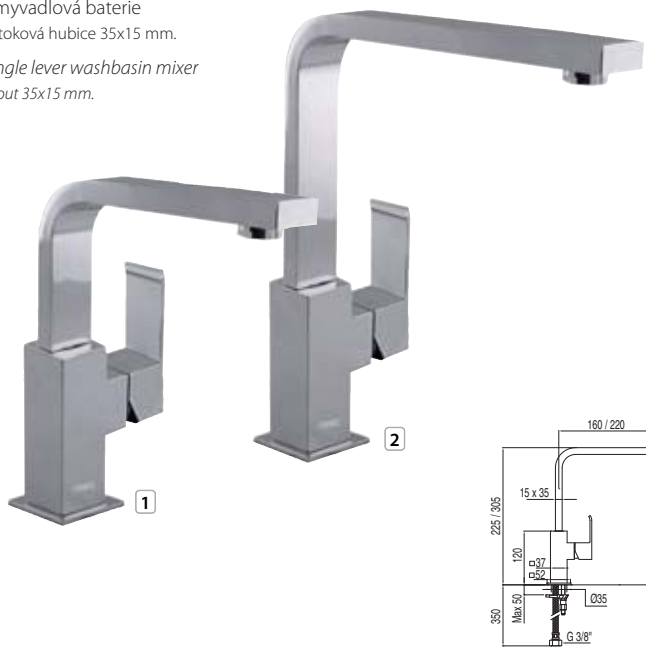

1		SLC 91.30.190	Cr	1.06.603	
2		SLC 91.30.190	Cr	1.06.604	

Cr = Cromo/Chrom/Chrome

Raccomandabile installare la valvola SIMPLE RAPID (non inclusa)
 Doporučuje se použít ventil Simple Rapid (není v ceně)
 Ideal assembly with SIMPLE RAPID valve (This is not included)

N

Monocomando lavabo
canna 34x10 mm.

Umyvadlová baterie
Výtoková hubice 34x10 mm.

Single lever washbasin mixer
spout 34x10 mm.

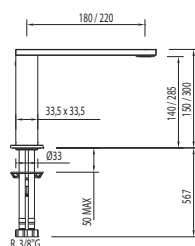
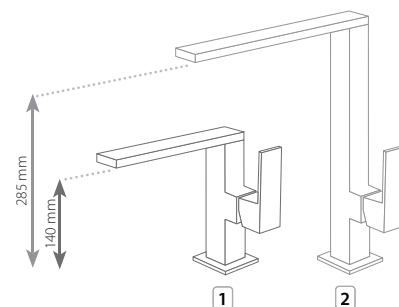

1			Cr	1.06.205.01
2			Cr	006.485.01

Monoblocco verticale CUADRO
canna 22x22 mm.

Umyvadlová baterie CUADRO
výtoková hubice 22x22 mm.

Single hole mixer CUADRO
spout 22x22 mm.

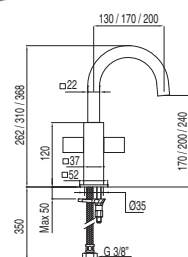
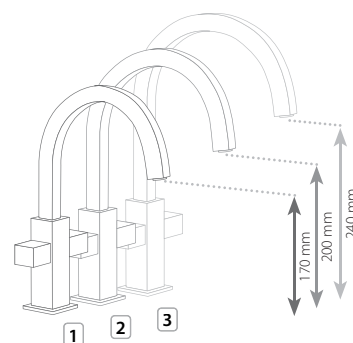

1		Cr	1.08.605
2		Cr	1.08.606
		Cr	1.08.497

CUADRO-TRES

Ref. / Kód / Nr.:

Monoblocco verticale CUADRO
canna 35x15 mm.

Umyvadlová baterie CUADRO
výtoková hubice 35x15 mm.

Single hole mixer CUADRO
spout 35x15 mm

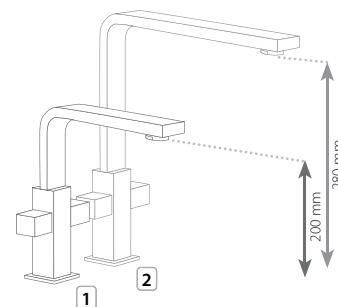
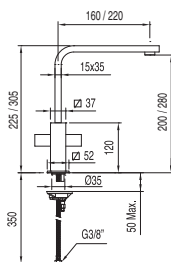
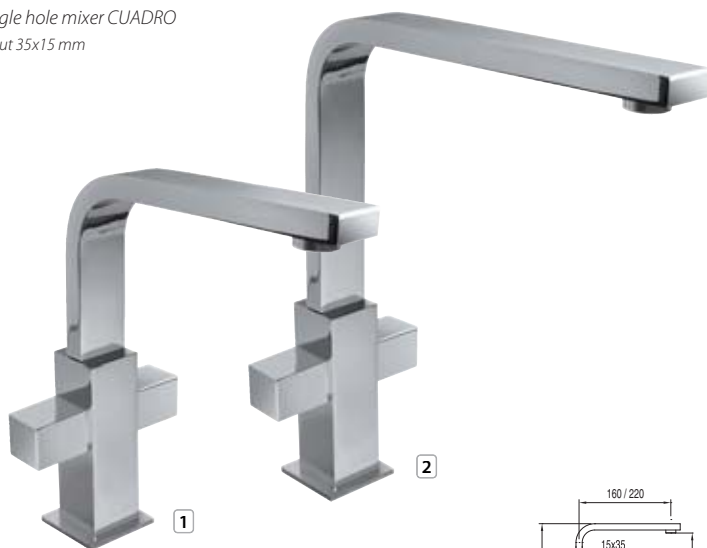

Cr 1.08.604



Cr 1.08.496



Monomando a muro
Canna lunga 165 mm.

Nastěnná směšovací baterie
Dlouhá výtoková hubice 165 mm.
Single lever wall washbasin mixer
Long spout 165 mm.

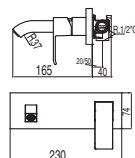

91.30.190

Cr 1.06.200

N



Monomando a muro

Nastěnná směšovací baterie
Single lever wall washbasin mixer

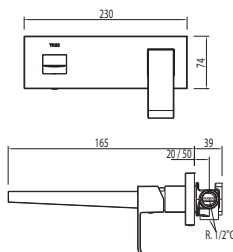

91.30.190

Cr 006.200.02



Monomando a muro
con bocca a cascata

Nastěnná směšovací baterie
s přívalovým přítokem
Single lever wall washbasin mixer
with cascade cast spout

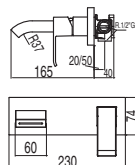

91.30.190

Cr 1.06.260
Ac 5.06.260.03

Cr = Cromo/Chrom/Chrome Ac = Acciaio/Kartáčovaná ocel/Steel

Ref. / Kód / Nr.:



Rubinetto lavabo 1 acqua

Umyvadlová baterie pro studenou nebo smíšenou vodu

Basin pillar tap only cold water

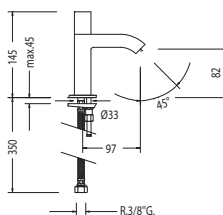

91.08.295.10

Cr

1.07.503

Bidet / Bidety / Bidets

Ref. / Kód / Nr.:

Monocomando bidet

Bidetová baterie

Single lever bidet mixer

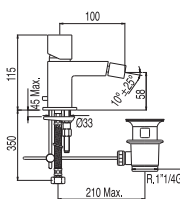

91.30.190

Cr

1.07.120



91.30.190

Cr

1.07.120.DA

1.07.120.60.DA

Monocomando bidet

Bidetová baterie

Single lever bidet mixer

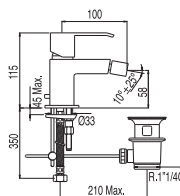

91.30.190

Cr

1.06.120

Ac

5.06.120.03



91.30.190

Cr

1.06.120.DA

5.06.120.03.DA

Monocomando bidet

Bidetová baterie

Single lever bidet mixer

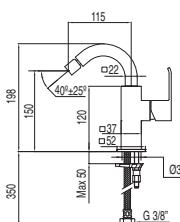

91.30.190

Cr

1.06.124



CUADRO-TRES

Ref. / Kód / Nr.:



Monoblocco bidet

Bidetová baterie
Single hole bidet mixer

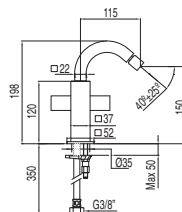

Cr 1.08.124

N



Monocomando bidet con doccia

Jednopávková baterie se sprškou pro bidet
Bidet mixer tap with small shower head

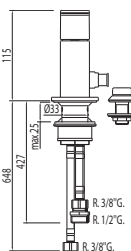

91.30.190

Cr 006.130.01



Monocomando ad incasso per bidé WC CUADRO

Supporto a destra o a sinistra, intercambiabile.
Flesso satinato.

Záchodová baterie se směšovačem teplot CUADRO
Pravý nebo levý podstavec, vyměnitelný.
Hadice satin.

Concealed single lever bidet/toilets CUADRO
Left or right support, interchangeable. Sateen hose.

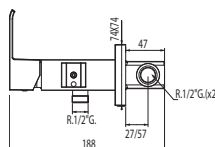

91.30.190

Cr 006.123.01

Cr 006.123.02 *



OTTONE
MOSAZ
BRASS

* Opzione Cartongesso

Možnost pro sádkartonové panely
Optie gips

Monocomandi bagno / Jednopávkový mechanismus vany / Bathtub mixer taps

Ref. / Kód / Nr.:



Monocomando doccia

Doccia anticalcare. Flessibile satin (91.34.609.15).

Sprchová baterie
Sprchová koncovka se systémem proti tvorbě vodního kamene, hadice satin. (91.34.609.15).

Single lever shower mixer
Shower Antilime. Shower hose satin (91.34.609.15).



BELGARDUA

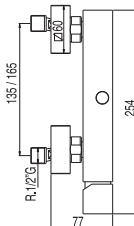

91.30.190

Cr 1.07.167
Nog 1.07.167.60
Ac 5.07.167.03



OTTONE
MOSAZ
BRASS



Monocomando vasca

Doccia anticalcare. Flessibile satin (91.34.609).

Vanová baterie
Sprchová koncovka se systémem proti tvorbě vodního kamene, hadice satin. (91.34.609).

Single lever bath and shower mixer
Shower Antilime. Shower hose satin (91.34.609).



BELGARDUA

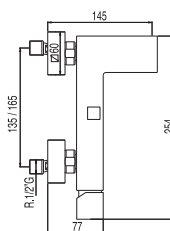

91.30.190

Cr 1.07.170.02
Nog 1.07.170.02.60
Ac 5.07.170.02.03



OTTONE
MOSAZ
BRASS

Cr = Cromo/Chrom/Chrome Nog = Noce/Ořech/Walnut Ac = Acciaio/Kartáčovaná ocel/Steel

Ref. / Kód / Nr.:

N



Gomito adattore bagno-doccia

Koleno k vanové baterii
Bath and shower adaptable column

con silenziatore
do zdi s gumovými tlumiči
with silencer

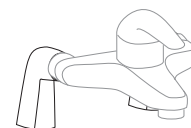
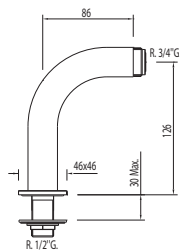

Cr 299.870.02

Ad incasso / Vestavěné / Built-in

Ref. / Kód / Nr.:



Monocomando ad incasso doccia

Podomítková sprchová baterie
Single lever concealed shower mixer

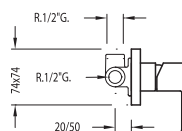

91.30.190

Cr 1.06.177
AC 5.06.177.03



Monocomando incasso bagno doccia con deviatore

Podomítková vanová baterie s ruční sprchou
Single lever concealed bath and shower mixer

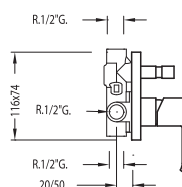

91.30.190

Cr 1.06.180
AC 5.06.180.03

N



Prolunga per monocomando incasso doccia

(si veda pagina 574)

Nástavec pro jednopákový zabudovaný systém sprchy
(viz ste 574)

Extension for built-in shower mixer tap
(see page 574)

Cr 1.06.177.10

N



Prolunga per monocomando incasso bagno-doccia

(si veda pagina 574)

Nástavec pro jednopákový zabudovaný systém vany/sprchy
(viz ste 574)

Extension for built-in bathtub-shower mixer tap
(see page 574)

Cr 1.06.180.10

CUADRO-TRES

Gruppi ad incasso / Vestavěné soupravy / Built-in sets

Ref. / Kód / Nr.:



Kit doccia ad incasso CUADRO

Con chiusura e regolazione di portata. Doccia fissa da 300x300 mm. Ottone (1.34.138.30)

Podomítkový set se sprchou CUADRO

S uzávěrem a regulací průtoku. Hlavová sprcha 300x300 mm. Mosaz (1.34.138.30)

Concealed shower set CUADRO

with water shut off and flow control. Fixed shower head 300x300 mm. Brass (1.34.138.30)

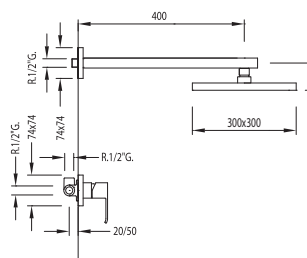

OTTONE
MOSAZ
BRASS



91.30.190

Cr

1.06.377



Kit doccia ad incasso CUADRO

Con chiusura e regolazione di portata. Doccia fissa da 300x300 mm. Ottone. (1.34.138.30).
Supporto per doccia. (91.06.182). Doccia anticalcare. (006.639.01). Flessibile satin. (91.34.609.15).

Podomítkový set se sprchou CUADRO

S uzávěrem a regulací průtoku. Hlavová sprcha 300x300 mm. Mosaz (1.34.138.30).

Pevný držák s vodní přípojkou pro hadic. (91.06.182). Sprchová koncovka se systémem proti tvorbě vodního kamene. (006.639.01). Hadice satin (91.34.609.15).

Concealed shower set CUADRO

with water shut off and flow control.
Fixed shower head 300x300 mm. Brass. (1.34.138.30). Elbow wall (91.06.182).
Antilime hand shower (006.639.01) and satin hose (91.34.609.15).

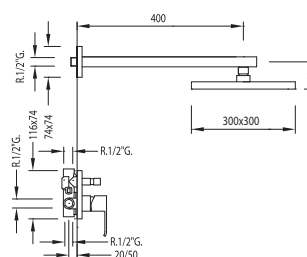

OTTONE
MOSAZ
BRASS



OTTONE
MOSAZ
BRASS



91.30.190

Cr

1.06.980



N

Kit doccia ad incasso CUADRO

Con chiusura e regolazione di portata. Doccia fissa da 160x550 mm. (299.903.03).
Supporto per doccia. (91.06.182). Doccia anticalcare. (006.639.01). Flessibile satin (91.34.609.15).

Podomítkový set se sprchou CUADRO

S uzávěrem a regulací průtoku. Hlavová sprcha 160x550 mm. (299.903.03). Pevný držák s vodní přípojkou pro hadic. (91.06.182). Sprchová koncovka se systémem proti tvorbě vodního kamene. (006.639.01). Hadice satin (91.34.609.15).

Concealed shower set CUADRO

with water shut off and flow control. Fixed shower head 160x550 mm. (299.903.03). Elbow wall. (91.06.182). Antilime hand shower. (006.639.01). Satin hose (91.34.609.15).

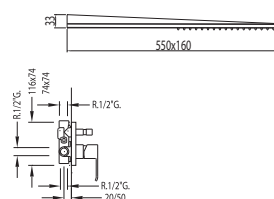

OTTONE
MOSAZ
BRASS



91.30.190

Cr

006.180.03

Cr = Cromo/Chrom/Chrome

N



Kit doccia ad incasso CUADRO

Con chiusura e regolazione di portata. Doccia acciaio inossidabile con cascata da 140x203 mm. (299.903.04). Supporto per doccia. (91.06.182). Doccia anticalcarea. (006.639.01). Flessibile satin (91.34.609.15).

Podomítkový set se sprchou CUADRO

S uzávěrem a regulací průtoku. Hlavová sprcha nerezová ocel s kaskádou 140x203 mm. (299.903.04). Pevný držák s vodní přípojkou pro hadic. (91.06.182). Sprchová koncovka se systémem proti tvorbě vodního kamene. (006.639.01). Hadice satin (91.34.609.15).

Concealed shower set CUADRO

with water shut off and flow control. Stainless steel shower with cascade 140x203 mm. (299.903.04). Elbow wall. (91.06.182). Antilime hand shower. (006.639.01). Satin hose (91.34.609.15).

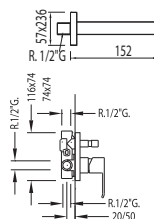

OTTONE
MOSAZ
BRASS



91.30.190

Cr

006.180.06



Kit doccia ad incasso CUADRO

Con chiusura e regolazione di portata. Doccia fissa da 300x300 mm. Ottone. (1.34.138.30). Asta antiscivolo lunga 900 mm. Ottone. (1.07.935). Presa a parete (91.06.183). Doccia anticalcarea. (006.639.01). Flessibile satin. (91.34.609.15).

Podomítkový set se sprchou CUADRO

S uzávěrem a regulací průtoku. Hlavová sprcha 300x300 mm. Mosaz (1.34.138.30). Posuvná tyč. Délka 900 mm. Mosaz (1.07.935). Pevný držák s vodní přípojkou pro hadici (91.06.183). Sprchová koncovka se systémem proti tvorbě vodního kamene. (006.639.01). Hadice satin (91.34.609.15).

Concealed shower set CUADRO

with water shut off and flow control. Fixed shower head 300x300 mm. Brass. (1.34.138.30). Bar-shower antilime. long. 900 mm. Brass (1.07.935). Elbow wall (91.06.183). Antilime hand shower (006.639.01) and satin hose (91.34.609.15).

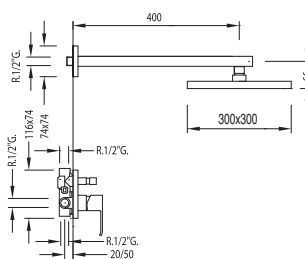

OTTONE
MOSAZ
BRASS



OTTONE
MOSAZ
BRASS



91.30.190

Cr

1.06.985

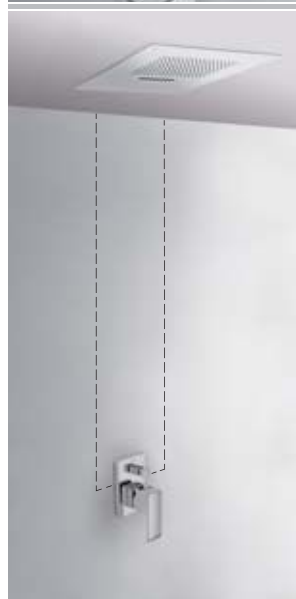

Kit doccia acciaio inossidabile ad incasso CUADRO

Con chiusura e regolazione di portata. Doccia con cascata 500x500 mm. 2 funzioni (299.516.02)

Podomítkový set Kartáčovaná ocel sprchou CUADRO

S uzávěrem a regulací průtoku. Hlavová sprcha s kaskádou 500x500 mm. 2 proudy (299.516.02)

Concealed shower set CUADRO

with water shut off and flow control. Stainless steel shower with cascade 500x500 mm. 2 positions (299.516.02)

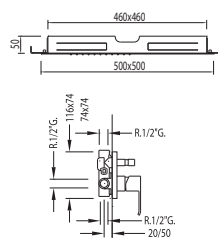

Cr

006.516.01

CUADRO-TRES

Ref. / Kód / Nr.:



Kit doccia acciaio inossidabile ad incasso CUADRO
 Con chiusura e regolazione di portata. Doccia con cascata 280x550 mm.
 2 funzioni (299.903.01)

Podomítkový set Kartáčovaná ocel sprchou CUADRO
 S uzávěrem a regulací průtoku. Hlavová sprcha S kaskádou 280x550 mm.
 2 proudy (299.903.01)

Concealed shower set CUADRO
with water shut off and flow control. Stainless steel shower with cascade 280x550 mm.
2 positions (299.903.01)

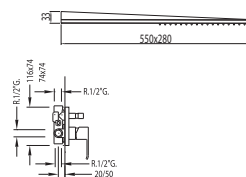

Cr 006.180.08

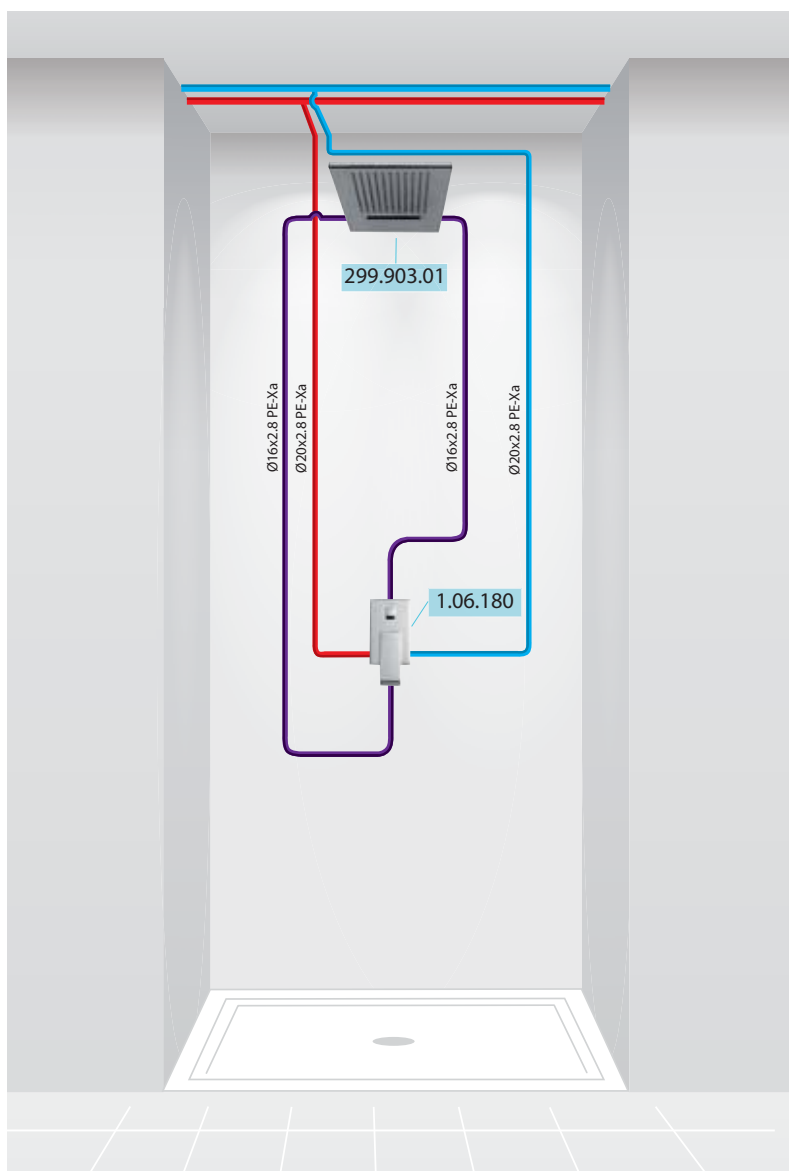

Cr = Cromo/Chrom/Chrome

CUADRO-TRES

Termostatiche / Termostatické / Thermostatically-controlled

Ref. / Kód / Nr.:



Doccia CUADRO termostatica
(Doccia anticalcare. Flesso satinato (91.34.609.15)).

Termostatická sprchová baterie CUADRO
(Sprchová koncovka se systémem proti tvorbě vodního kamene. Sprchová hadice satin (91.34.609.15)).

Wall thermostatic shower mixer CUADRO

(Shower Antilime. Shower hose satin (91.34.609.15)).

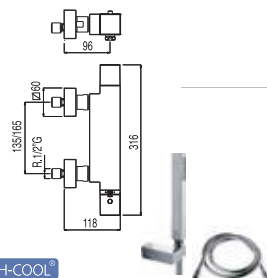

Cr 1.07.164



OTTONE
MOSAZ
BRASS

Cr 1.07.164.9
Ac 5.07.164.03.9



Bagno doccia CUADRO termostatica
Con bocca a cascata. (Doccia anticalcare. Flesso satinato (91.34.609)).

Termostatická vanová a sprchová baterie CUADRO
S kaskádou. (Sprchová koncovka se systémem proti tvorbě vodního kamene. Sprchová hadice satin (91.34.609)).

Wall thermostatic bath and shower mixer CUADRO

with cascade. (Shower Antilime. Shower hose satin (91.34.609)).

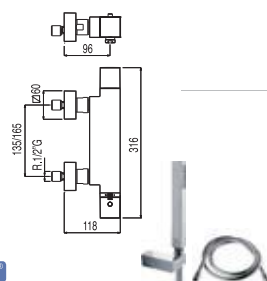

Cr 1.07.174



OTTONE
MOSAZ
BRASS

Cr 1.07.174.9
Ac 5.07.174.03.9

Gruppi termostatici / Termostatické soupravy / Thermostatically-controlled sets

Ref. / Kód / Nr.:



Set doccia CUADRO termostatica

Doccia fissa da 300x300 mm. Ottone (1.34.138.30). Doccia anticalcare (006.639.01). Flessibile satin (91.34.609.15). Invertitore integrato nel regolatore di portata (si veda pagina 576)

Termostatický sprchový set CUADRO

Hlavová sprcha 300x300 mm. Mosaz (1.34.138.30). Sprchová koncovka se systémem proti tvorbě vodního kamene (006.639.01), hadice satin (91.34.609.15). Přepínač proudů integrovaný s regulátorem tlaku (viz str. 576)

Wall thermostatic shower mixer CUADRO

Fixed shower head 300x300 mm. Brass (1.34.138.30). Antilime hand shower (006.639.01) and satin hose (91.34.609.15). Diverter integrated in the flow control (see page 576)

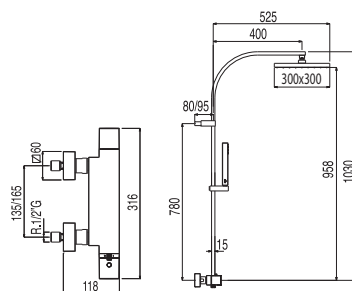

OTTONE
MOSAZ
BRASS



OTTONE
MOSAZ
BRASS

Cr 1.07.395

Cr = Cromo/Chrom/Chrome Ac = Acciaio/Kartáčovaná ocel/Steel

CUADRO-TRES

Ref. / Kód / Nr.:



N

Kit doccia termostatica CUADRO

Con chiusura e regolazione di portata. (2 vie) Doccia acciaio inossidabile da 210x550 mm. (299.903.02). Supporto per doccia. (91.06.182). Doccia anticalcarea. (006.639.01). Flessibile satin (91.34.609.15).

Termostatický sprchový set CUADRO

S uzávěrem a regulací průtoku. (Dvoucestný) Hlavová sprcha nerezová ocel 210x550 mm. (299.903.02). Pevný držák s vodní přípojkou pro hadic. (91.06.182). Sprchová koncovka se systémem proti tvorbě vodního kamene (006.639.01). Hadice satin (91.34.609.15).

Thermostatic bar-shower CUADRO

with water shut off and flow control. (2 ways) Stainless steel shower 210x550 mm. (299.903.02). Elbow wall (91.06.182). Antilime hand shower (006.639.01). Satin hose (91.34.609.15).

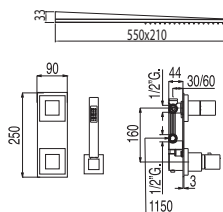

OTTONE
MOSAZ
BRASS



Cr 007.250.05



N

Kit doccia termostatica CUADRO

Con chiusura e regolazione di portata. (2 vie) Doccia acciaio inossidabile con cascata 140x203 mm. (299.903.04). Supporto per doccia. (91.06.182). Doccia anticalcarea. (006.639.01). Flessibile satin (91.34.609.15).

Termostatický sprchový set CUADRO

S uzávěrem a regulací průtoku. (Dvoucestný) Hlavová sprcha nerezová ocel S kaskádou 140x203 mm. (299.903.04). Pevný držák s vodní přípojkou pro hadic. (91.06.182). Sprchová koncovka se systémem proti tvorbě vodního kamene (006.639.01). Hadice satin (91.34.609.15).

Thermostatic bar-shower CUADRO

with water shut off and flow control. (2 ways) Stainless steel shower with cascade 140x203 mm. (299.903.04). Elbow wall (91.06.182). Antilime hand shower (006.639.01). Satin hose (91.34.609.15).

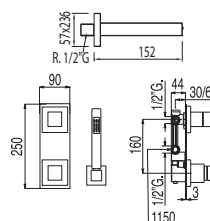

OTTONE
MOSAZ
BRASS



Cr 007.250.12



N

Kit doccia termostatica CUADRO-SLIM

Con chiusura e regolazione di portata. (2 vie) Doccia acciaio inossidabile con cascata 280x550 mm. 2 funzioni (299.903.01)

Termostatický sprchový set CUADRO-SLIM

S uzávěrem a regulací průtoku. (Dvoucestný) Hlavová sprcha nerezová ocel S kaskádou 280x550 mm. 2 proudy (299.903.01)

Thermostatic bar-shower CUADRO-SLIM

with water shut off and flow control. (2 ways) Stainless steel shower with cascade 280x550 mm. 2 positions (299.903.01)

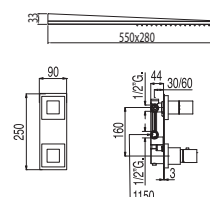

Cr 202.865.01

Cr = Cromo/Chrom/Chrome

Kit doccia termostatica CUADRO-SLIM

Con chiusura e regolazione di portata. (2 vie) Doccia con cascata 500x500 mm. 2 funzioni (299.516.02)

Termostatický sprchový set CUADRO-SLIM

S uzávěrem a regulací průtoku. (Dvoucestný) Hlavová sprcha S kaskádou 500x500 mm. 2 proudy (299.516.02)

Thermostatic bar-shower CUADRO-SLIM

with water shut off and flow control. (2 ways) Stainless steel shower with cascade 500x500 mm. 2 positions (299.516.02)

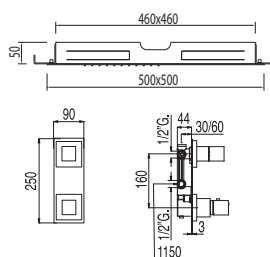

Cr

007.865.01

N

Kit doccia termostatica CUADRO

Con chiusura e regolazione di portata. (3 vie) Doccia acciaio inossidabile con cascata 280x550 mm. 2 funzioni (299.903.01). Supporto per doccia. (91.06.182). Doccia anticalcare. (006.639.01). Flessibile satin (91.34.609.15).

Termostatický sprchový set CUADRO

S uzávěrem a regulací průtoku. (Trojcestný) Hlavová sprcha nerezová ocel S kaskádou 280x550 mm. 2 proudy (299.903.01). Pevný držák s vodní přípojkou pro hadic. (91.06.182). Sprchová koncovka se systémem proti tvorbě vodního kamene. (006.639.01). Hadice satin (91.34.609.15).

Thermostatic bar-shower CUADRO

with water shut off and flow control. (3 ways) Stainless steel shower with cascade 280x550 mm. 2 positions (299.903.01). Elbow wall. (91.06.182). Antilime hand shower. (006.639.01). Satin hose (91.34.609.15).

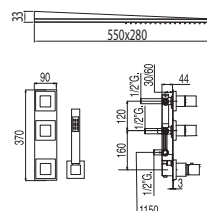
 OTTONE
MOSAZ
BRASS

Cr

007.866.02

Kit doccia termostatica CUADRO

Con chiusura e regolazione di portata. (3 vie) Doccia fissa da 300x300 mm. (1.34.138.30). Ottone. Supporto per doccia. (91.06.182). Doccia anticalcare. (006.639.01). Flessibile satin (91.34.609.15).

Termostatický sprchový set CUADRO

S uzávěrem a regulací průtoku. (Trojcestný) Hlavová sprcha 300x300 mm. (1.34.138.30). Mosaz. Pevný držák s vodní přípojkou pro hadic. (91.06.182). Sprchová koncovka se systémem proti tvorbě vodního kamene. (006.639.01). Hadice satin (91.34.609.15).

Thermostatic bar-shower CUADRO

with water shut off and flow control. (3 ways) Fixed shower head 300x300 mm. (1.34.138.30). Brass. Elbow wall. (91.06.182). Antilime hand shower. (006.639.01). Satin hose (91.34.609.15).

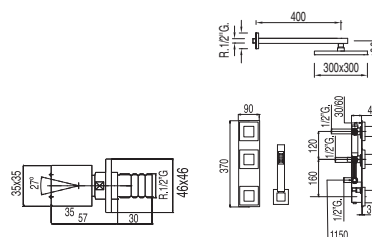
 OTTONE
MOSAZ
BRASS

 OTTONE
MOSAZ
BRASS

Cr

1.07.178

CUADRO-TRES

Ref. / Kód / Nr.:

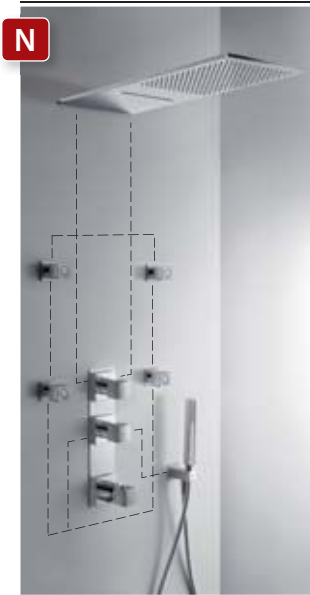

Kit doccia termostatica CUADRO

Con chiusura e regolazione di portata. (4 vie) Doccia acciaio inossidabile con cascata 280x550 mm. 2 funzioni (299.903.01). Supporto per doccia. (91.06.182). Doccia anticalcarea. (006.639.01). Flessibile satin (91.34.609.15).

Termostatický sprchový set CUADRO

S uzávěrem a regulací průtoku. (Čtyřcestný) Hlavová sprcha nerezová ocel s kaskádou 280x550 mm. 2 proudy (299.903.01). Pevný držák s vodní přípojkou pro hadic. (91.06.182). Sprchová koncovka se systémem proti tvorbě vodního kamene. (006.639.01). Hadice satin (91.34.609.15).

Thermostatic bar-shower CUADRO

with water shut off and flow control. (4 ways) Stainless steel shower with cascade 280x550 mm. 2 positions (299.903.01). Elbow wall. (91.06.182). Antilime hand shower. (006.639.01). Satin hose (91.34.609.15).

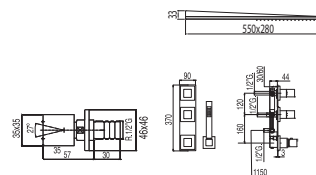

OTTONE
MOSAZ
BRASS



Cr 007.250.09

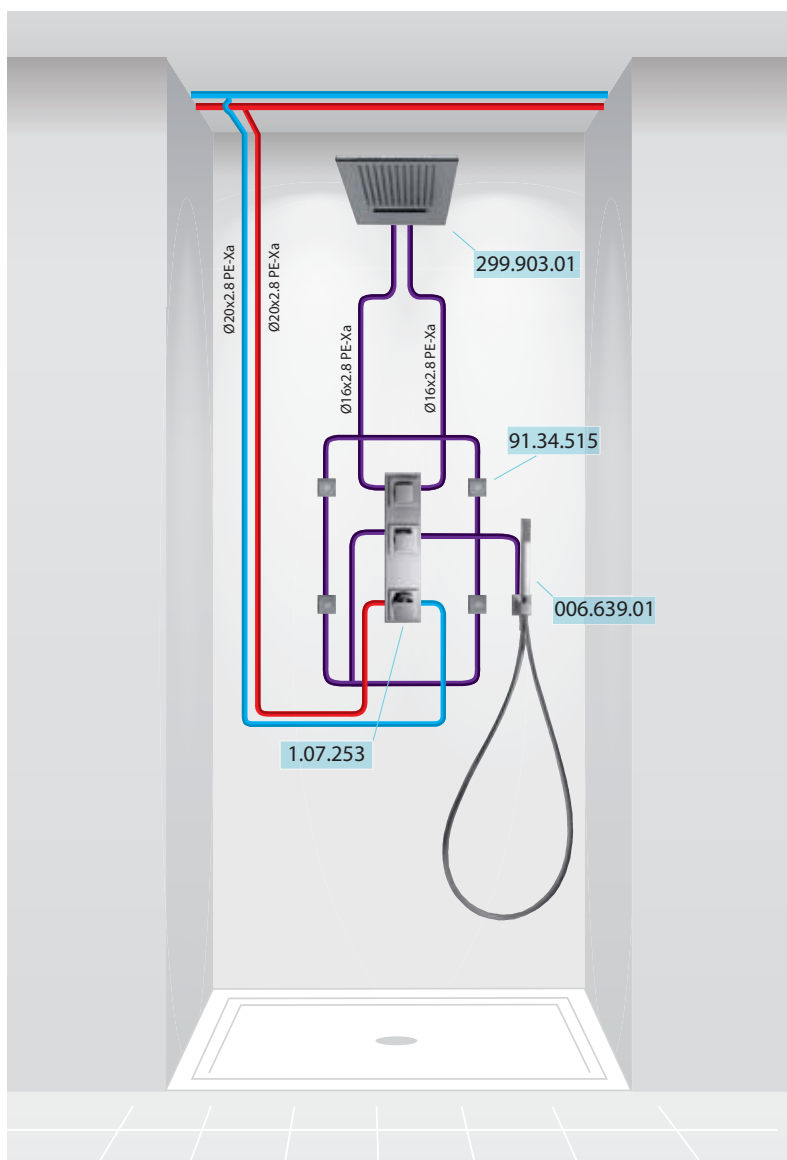

Cr = Cromo/Chrom/Chrome



Kit doccia termostatica CUADRO

Con chiusura e regolazione di portata. (3 vie) Doccia con cascata 500x500 mm. 2 funzioni (299.516.02). Supporto per doccia. (91.06.182). Doccia anticalcarea. (006.639.01). Flessibile satin (91.34.609.15).

Termostatický sprchový set CUADRO

S uzávěrem a regulací průtoku. (Trojcestný) Hlavová sprcha s kaskádou 500x500 mm. 2 proudy (299.516.02). Pevný držák s vodní přípojkou pro hadic. (91.06.182). Sprchová koncovka se systémem proti tvorbě vodního kamene. (006.639.01). Hadice satin (91.34.609.15).

Thermostatic bar-shower CUADRO

with water shut off and flow control. (3 ways) Stainless steel shower with cascade 500x500 mm. 2 positions (299.516.02). Elbow wall. (91.06.182). Antilime hand shower. (006.639.01). Satin hose (91.34.609.15).

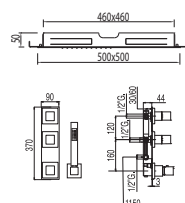

OTTONE
MOSAZ
BRASS

Cr	007.866.01
----	------------

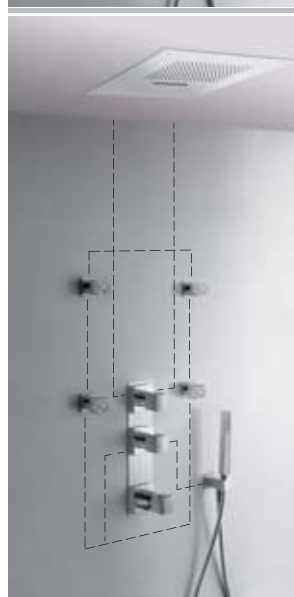

Kit doccia termostatica CUADRO

Con chiusura e regolazione di portata. (4 vie) Doccia con cascata 500x500 mm. 2 funzioni (299.516.02). Supporto per doccia. (91.06.182). Doccia anticalcarea. (006.639.01). Flessibile satin (91.34.609.15).

Termostatický sprchový set CUADRO

S uzávěrem a regulací průtoku. (Čtyřcestný) Hlavová sprcha s kaskádou 500x500 mm. 2 proudy (299.516.02). Pevný držák s vodní přípojkou pro hadic. (91.06.182). Sprchová koncovka se systémem proti tvorbě vodního kamene. (006.639.01). Hadice satin (91.34.609.15).

Thermostatic bar-shower CUADRO

with water shut off and flow control. (4 ways) Stainless steel shower with cascade 500x500 mm. 2 positions (299.516.02). Elbow wall. (91.06.182). Antilime hand shower. (006.639.01). Satin hose (91.34.609.15).

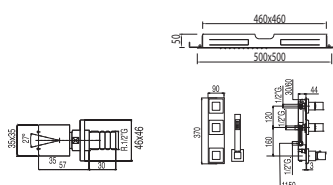

OTTONE
MOSAZ
BRASS

Cr	007.867.01
----	------------



Kit doccia termostatica CUADRO

Con chiusura e regolazione di portata. (3 vie) Doccia fissa da 300x300 mm. (1.34.138.30). Ottone. Supporto per doccia. (91.06.182). Doccia anticalcarea. (006.639.01). Flessibile satin (91.34.609.15).

Termostatický sprchový set CUADRO

S uzávěrem a regulací průtoku. (Trojcestný) Hlavová sprcha 300x300 mm. (1.34.138.30). Mosaz. Pevný držák s vodní přípojkou pro hadic. (91.06.182). Sprchová koncovka se systémem proti tvorbě vodního kamene. (006.639.01). Hadice satin (91.34.609.15).

Thermostatic bar-shower CUADRO

with water shut off and flow control. (3 ways) Fixed shower head 300x300 mm. (1.34.138.30). Brass. Elbow wall. (91.06.182). Antilime hand shower. (006.639.01). Satin hose (91.34.609.15).

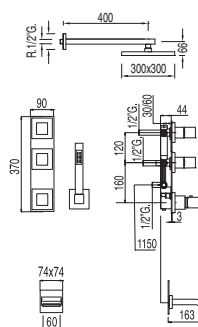

OTTONE
MOSAZ
BRASS



OTTONE
MOSAZ
BRASS

Cr	1.07.144
----	----------

CUADRO-TRES

Ref. / Kód / Nr.:	
-------------------	--



Batteria vasca termostatica CUADRO

Con bocca a cascata. Supporto per doccia. (91.06.182). Doccia anticalcare. (006.639.01). Flessibile satin (91.34.609).

Termostatická podomítková vanová baterie se sprchou

S přívalem vtokem. Pevný držák s vodní přípojkou pro hadic. (91.06.182). Sprchová koncovka se systémem proti tvorbě vodního kamene. (006.639.01). Hadice satin (91.34.609).

Thermostatic bath CUADRO

with cascade cast spout. Elbow wall. (91.06.182). Antilime hand shower. (006.639.01). Satin hose (91.34.609).

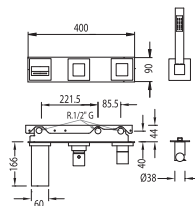

OTTONE
MOSAZ
BRASS

Cr	1.07.192	
----	----------	--



Bocca a cascata set doccia

Přívalem vtokem vanový set

Cascade cast spout bath mixer

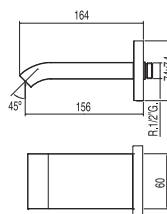

Cr	1.07.181	
Ac	5.07.181.03	



Bocca a cascata

Přívalem vtokem

Cascade cast spout

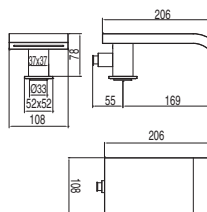

Cr	1.87.182.50	
Ac	5.87.182.50.03	

Elementi per doccia / Sprchové prvky / Shower parts Ref. / Kód / Nr.:



Asta antiscivolo CUADRO
 Lungo 842 mm. Ottone
 Posuvná tyč CUADRO
 Délka 842 mm. Mosaz
Sliding bar CUADRO
 Brass long. 842 mm.

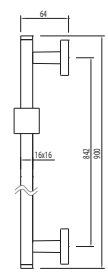

Cr	1.07.935	
----	----------	--



Kit anticalcare CUADRO
 Ottone lungo 842 mm. Doccia anticalcare (006.639.01). Flessibile satin (91.34.609).
 Sprchový set CUADRO
 Mosaz long. 842 mm. Ruční sprchy se systémem proti vzniku vodního kamene (006.639.01), hadice satin (91.34.609)
Bar-shower antilime CUADRO
 Brass long. 842 mm. Antilime hand shower (006.639.01) and satin hose (91.34.609)

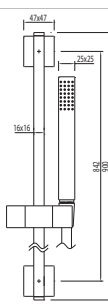

Cr	1.07.934	
----	----------	--

kit doccia CUADRO
 doccia fissa da 250x250 mm. (1.34.138.26). Doccia anticalcare (006.639.01). Flessibile satin (91.34.609.15)

Sprchový set CUADRO
 Hlavová sprcha 250x250 mm. (1.34.138.26). Sprchová koncovka se systémem proti tvorbě vodního kamene. (006.639.01). Hadice satin (91.34.609.15). Se spodní přípojkou vody
Bar-shower CUADRO set
 fixed shower head 250x250 mm. (1.34.138.26). Antilime hand shower. (006.639.01). Satin hose (91.34.609.15) with lower water point

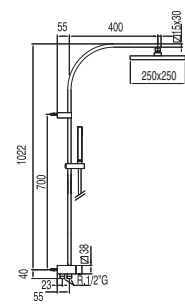

Cr	1.07.926	
----	----------	--

Set monocomando ad incasso con doccia CUADRO
 doccia fissa da 250x250 mm. (1.34.138.26). Doccia anticalcare (006.639.01). Flessibile satin (91.34.609.15)

Podomítkový set se sprchou CUADRO
 Hlavová sprcha 250x250 mm. (1.34.138.26). Sprchová koncovka se systémem proti tvorbě vodního kamene. (006.639.01). Hadice satin (91.34.609.15). Se spodní přípojkou vody
Bar-shower CUADRO set
 fixed shower head 250x250 mm. (1.34.138.26). Antilime hand shower. (006.639.01). Satin hose (91.34.609.15). Adaptable to a bath and shower mixer

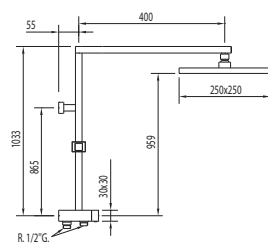

Cr	1.07.476	
----	----------	--

Cr = Cromo/Chrom/Chrome

CUADRO-TRES

Ref. / Kód / Nr.:

kit doccia CUADRO

doccia fissa da 250x250 mm. (1.34.138.26). Doccia anticalcare (006.639.01). Flessibile satin (91.34.609.15)

Sprchový set CUADRO

Hlavová sprcha 250x250 mm. (1.34.138.26). Sprchová koncovka se systémem proti tvorbě vodního kamene. (006.639.01). Hadice satin (91.34.609.15). Se spodní přípojkou vody

Concealed thermostatic shower set CUADRO

fixed shower head 250x250 mm. (1.34.138.26). Antilime hand shower. (006.639.01). Satin hose (91.34.609.15) with lower water point

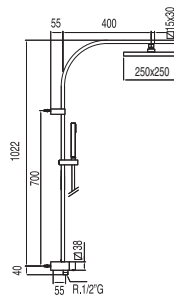

OTTONE
MOSAZ
BRASS

Cr 1.07.131

Rubinetti di arresto / Průchozí ventily / Shutoff valves

Ref. / Kód / Nr.:



Rubinetto di arresto filettato 1/2"

Ventil se závitem 1/2"

1/2" threaded-ends gate-valve

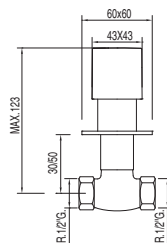

Cr 1.07.155



Rubinetto di arresto filettato 3/4"

Ventil se závitem 3/4"

3/4" threaded-ends gate-valve

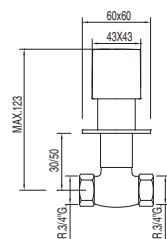

Cr 1.07.511

Cr = Cromo/Chrom/Chrome

Ricambi / Náhradní díly / Spare parts

	Manopola Úchyt Lever				
		Cr	91.06.020.10		
		Ac	91.06.020.153		
	Manopola Úchyt Lever				
		Cr	91.06.020.20		
		Ac	91.06.020.253		
	Volano Otočný ovladač Handle				
		Cr	91.07.020.10		
		Ac	91.07.020.153		
	Volano Lato portata Otočný ovladač na straně regulace proudu vody Handle Flow side	(per ref. / Kód / for Nr.: 1.07.164, 1.07.164.9, 1.07.174, 1.07.174.9)			
		Cr	91.94.006.02		
		Nog	91.07.030.10		
	Volano Lato portata Otočný ovladač na straně regulace proudu vody Handle Flow side	(per ref. / Kód / for Nr.: 1.07.395)			
		Cr	91.94.006.20		
	Manopola lato temperatura Kohoutek na straně s regulací teploty Temperature side handle	(per ref. / Kód / for Nr.: 1.07.164, 1.07.164.9, 1.07.174, 1.07.174.9, 1.07.395)			
		Cr	91.94.006.01		
		Nog	91.07.030.20		
	Cartuccia termostatica + volano Termostatická vložka s otočným ovládačem Thermostatic cartridge stem + Handle	(per ref. / Kód / for Nr.: 07.164, 07.174, 07.395)			
		Cr	91.06.161.10		
	Base per lavabo e bidet Kroužek pod umyvadlové a bidetové baterie Mixer base				
		Cr	91.06.100.01		
	Rosone con eccentrico Krycí rozeta s excentrickou spojkou Cover plate				
		Cr	91.07.170.09		
	Rotula Bidetové klouby Ball-and-socket joint bidet mixer				
		Cr	91.07.672		
	Invertitore automatico Automatický přepínač Diverter	(per ref. / Kód / for Nr.: 06.161.02, 07.161.02)			
		Cr	299.553.02		
	Invertitore Přepínač Diverter	(per ref. / Kód / for Nr.: 06.180)			
		Cr	91.06.180.20		
	Invertitore Přepínač Diverter	(per ref. / Kód / for Nr.: 1.07.170.02)			
		Cr	91.06.251		
	Distributore bagno doccia Přepínač pro vanová baterie bath and shower mixer diverter	(per ref. / Kód / for Nr.: 1.07.131)			
		Cr	91.06.197.30		
	Distributore bagno doccia Přepínač pro vanová baterie bath and shower mixer diverter	(per ref. / Kód / for Nr.: 1.07.926)			
		Cr	91.06.914.80		
	Aeratore a scomparsa e chiusura Vnitřní perlátor + klíč Aerator + key				
					91.34.665
	Scarico automatico Automatický odtok Pup-up waste	1,1/4"			
		Cr	91.34.375.10		
	Set asta e pulsante Sada přepínače s vedením a úchytem Button and rod set				
		Cr	91.34.375		
	Cartuccia Řídicí vložka Cartridge stem	Ø 25 mm.			
					91.30.190
	Vitone fredda Hlava ke standardním bateriím studená Cartridge stem cold	(per ref. / Kód / for Nr.: 08.496, 08.497, 08.498)			
					91.08.292.10
	Vitone calda Hlava ke standardním bateriím teplá Cartridge stem hot	(per ref. / Kód / for Nr.: 08.496, 08.497, 08.498)			
					91.08.292.20



MAX-TRES

061.307.01

061.903.01

MAX-TRES





061.172.01

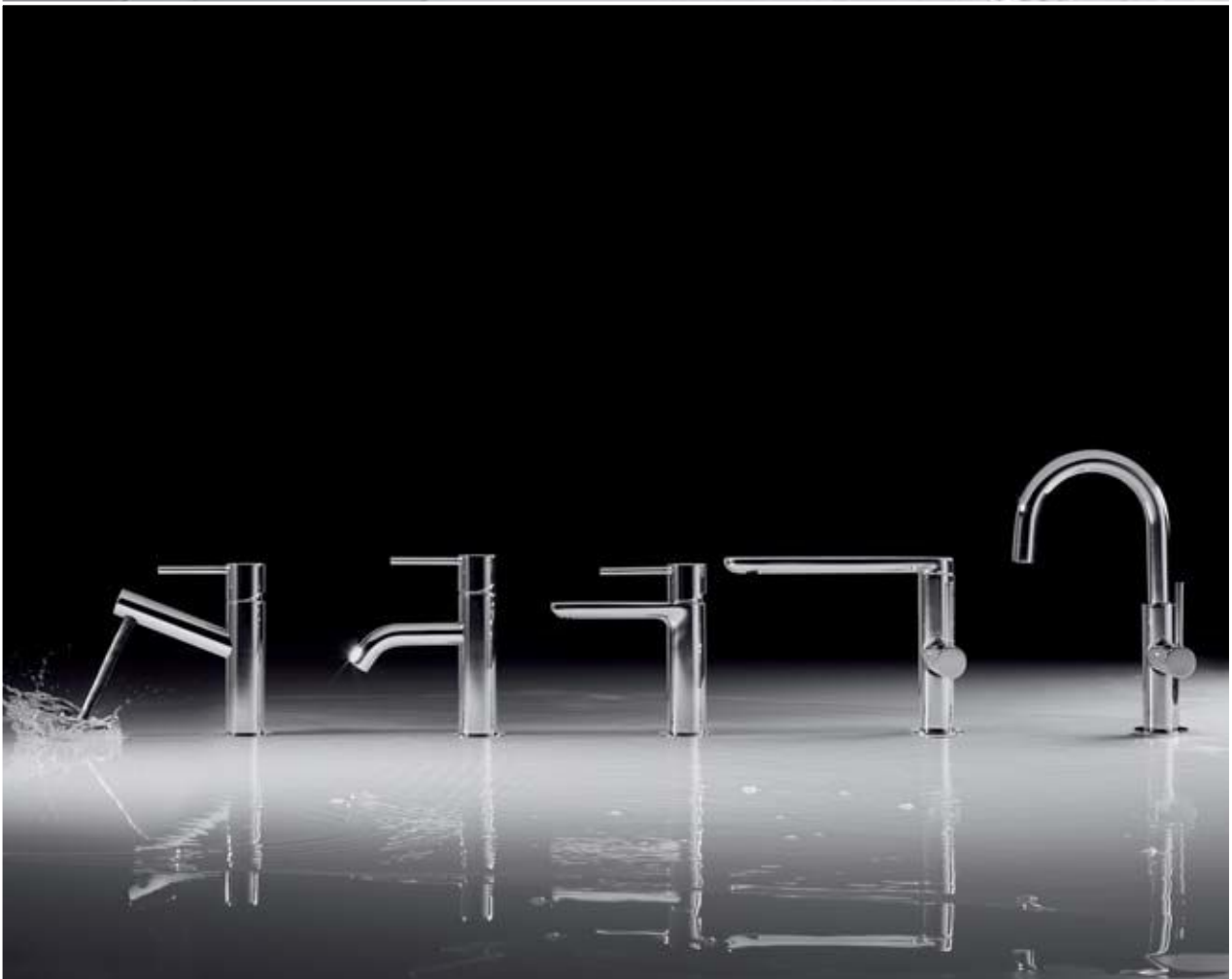

MAX-TRES





061.210.01



062.180.05

MAX-TRES





MAX-TRES



061.170.01

MAX-TRES

Lavabi / Umyvadla / Basins

Ref. / Kód / Nr.:

N



Monocomando lavabo
 Umyvadlová baterie
 Single lever washbasin mixer

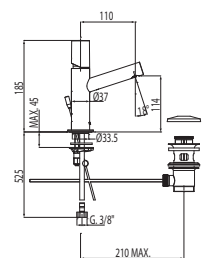

Ø37

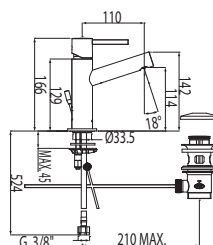

91.07.190.05

Cr

061.103.01



91.07.190.05

Cr

061.103.01.D



91.07.190.05

Cr

062.103.01



91.07.190.05

Cr

062.103.01.D

MAX-TRES

Ref. / Kód / Nr.:

N

Monocomando lavabo

Umyvadlová baterie

Single lever washbasin mixer

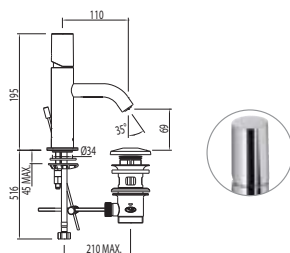

91.07.190.05

Cr

061.903.01



91.07.190.05

Cr

061.903.01.D

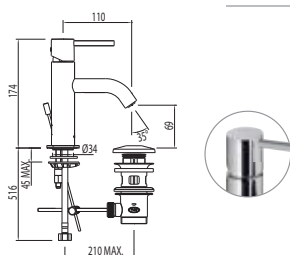

91.07.190.05

Cr

062.903.01



91.07.190.05

Cr

062.903.01.D

N

Monocomando lavabo con prolunga inferiore

Umyvadlová baterie

S prodlužkou

Single lever washbasin mixer

with base extension

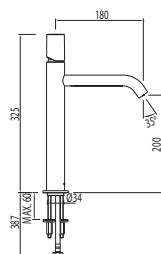

91.07.190.05

Cr

061.307.01

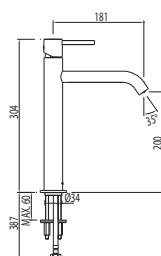

91.07.190.05

Cr

062.307.01

Cr = Cromo/Chrom/Chrome

Raccomandabile installare la valvola SIMPLE RAPID (non inclusa)
Doporučuje se použít ventil Simple Rapid (není v ceně)
Ideal assembly with SIMPLE RAPID valve (This is not included)

N

Monocomando lavabo
 Umyvadlová baterie
 Single lever washbasin mixer

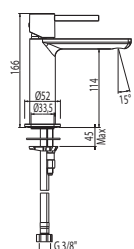
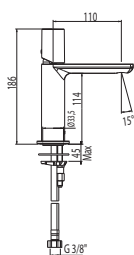

* NOTA: La rubinetteria con canna a cascata è accompagnata da 2 rubinetti di regolazione con filtro (Ref: 91.34.525)
 * POZNÁMKA: Baterie typu vodopádu je doplněna dvěma regulačními kohouty s filtrem (Kód.: 91.34.525)
 * NOTE: Taps with a cascade spout come with 2 regulation valves and a filter (Nr.: 91.34.525)



91.30.190	Cr	061.103.02
-----------	----	------------



91.30.190	Cr	061.103.02.D
-----------	----	--------------

91.30.190	Cr	061.103.03
-----------	----	------------

91.30.190	Cr	061.103.03.D
-----------	----	--------------



91.30.190	Cr	062.103.02
-----------	----	------------



91.30.190	Cr	062.103.02.D
-----------	----	--------------

91.30.190	Cr	062.103.03
-----------	----	------------

91.30.190	Cr	062.103.03.D
-----------	----	--------------

N

Monocomando lavabo
 con bocca a cascata aperta
 Umyvadlová baterie
 výtok otevřená kaskáda
 Single lever washbasin mixer
 with open cascade spout

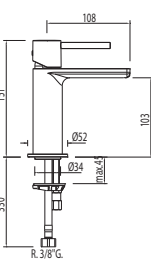
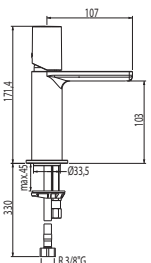

* NOTA: La rubinetteria con canna a cascata è accompagnata da 2 rubinetti di regolazione con filtro (Ref: 91.34.525)
 * POZNÁMKA: Baterie typu vodopádu je doplněna dvěma regulačními kohouty s filtrem (Kód.: 91.34.525)
 * NOTE: Taps with a cascade spout come with 2 regulation valves and a filter (Nr.: 91.34.525)



91.30.190	Cr	061.110.01
-----------	----	------------



91.30.190	Cr	062.110.01
-----------	----	------------

Cr = Cromo/Chrom/Chrome

Raccomandabile installare la valvola SIMPLE RAPID (non inclusa)
 Doporučuje se použít ventil Simple Rapid (není v ceně)
 Ideal assembly with SIMPLE RAPID valve (This is not included)

MAX-TRES

Ref. / Kód / Nr.:



Monocomando lavabo
con prolunga inferiore

Umyvadlová baterie

S prodlužkou

Single lever washbasin mixer

with base extension

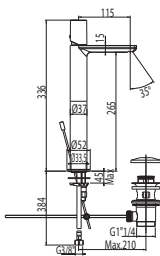
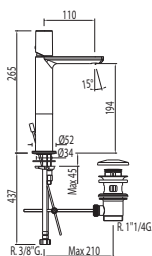
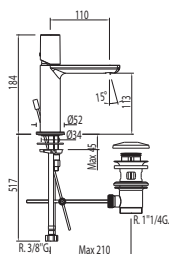
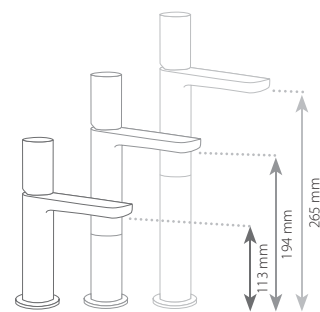

* NOTA: La rubinetteria con canna a cascata è accompagnata da 2 rubinetti di regolazione con filtro (Ref: 91.34.525)

* POZNÁMKA: Baterie typu vodopádu je doplněna dvěma regulačními kohouty s filtrem (Kód: 91.34.525)

* NOTE: Taps with a cascade spout come with 2 regulation valves and a filter (Nr.: 91.34.525)



91.30.190

Cr

061.103.02



91.30.190

Cr

061.103.02.D



91.30.190

Cr

061.103.03



91.30.190

Cr

061.103.03.D



91.30.190

Cr

061.103.04



91.30.190

Cr

061.103.04.D



91.30.190

Cr

061.103.05

91.30.190

Cr

061.103.05.D

91.30.190

Cr

061.103.06

91.30.190

Cr

061.103.06.D

91.30.190

Cr

061.103.07

91.30.190

Cr

061.103.07.D

Cr = Cromo/Chrom/Chrome

Raccomandabile installare la valvola SIMPLE RAPID (non inclusa)
Doporučuje se použít ventil Simple Rapid (není v ceně)
Ideal assembly with SIMPLE RAPID valve (This is not included)

N Monocomando lavabo
con prolunga inferiore

Umyvadlová baterie
S prodlužkou

Single lever washbasin mixer
with base extension

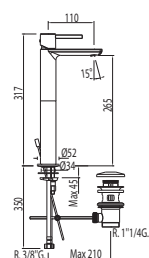
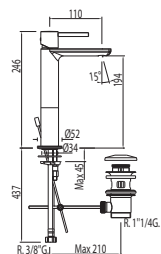
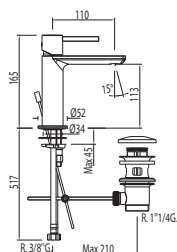
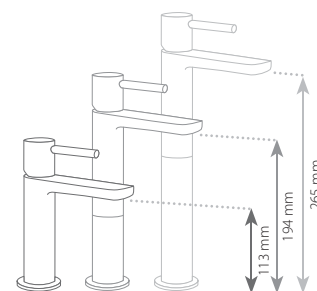

91.30.190

Cr

062.103.02



91.30.190

Cr

062.103.02.D



91.30.190

Cr

062.103.03



91.30.190

Cr

062.103.03.D



91.30.190

Cr

062.103.04



91.30.190

Cr

062.103.04.D



91.30.190

Cr

062.103.05



91.30.190

Cr

062.103.05.D



91.30.190

Cr

062.103.06



91.30.190

Cr

062.103.06.D



91.30.190

Cr

062.103.07



91.30.190

Cr

062.103.07.D

* NOTA: La rubinetteria con canna a cascata è accompagnata da 2 rubinetti di regolazione con filtro (Ref: 91.34.525)

* POZNÁMKA: Baterie typu vodopádu je doplněna dvěma regulačními kohouty s filtrem (Kód.: 91.34.525)

* NOTE: Taps with a cascade spout come with 2 regulation valves and a filter (Nr.: 91.34.525)

Cr = Cromo/Chrom/Chrome



Raccomandabile installare la valvola SIMPLE RAPID (non inclusa)
Doporučuje se použít ventil Simple Rapid (není v ceně)
Ideal assembly with SIMPLE RAPID valve (This is not included)

MAX-TRES

Ref. / Kód / Nr.:

N Monocomando lavabo
 Umyvadlová baterie
 Single lever washbasin mixer

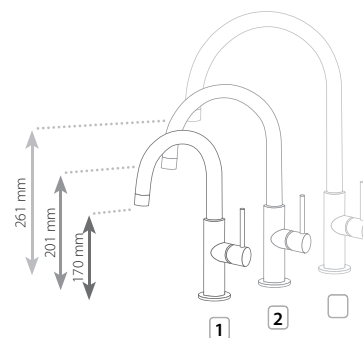

1	91.30.190	Cr	062.904.03
---	-----------	----	------------

2	91.30.190	Cr	062.904.02
---	-----------	----	------------

3	91.30.190	Cr	062.904.01
---	-----------	----	------------



N Monocomando lavabo
 canna 35x15 mm.
 Umyvadlová baterie
 Výtoková hubice 35x15 mm.
 Single lever washbasin mixer
 spout 35x15 mm.

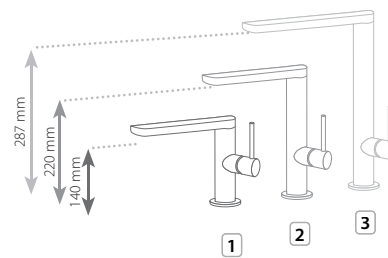

1	91.30.190	Cr	062.905.03
---	-----------	----	------------

2	91.30.190	Cr	062.905.02
---	-----------	----	------------

3	91.30.190	Cr	062.905.01
---	-----------	----	------------



Cr = Cromo/Chrom/Chrome

Raccomandabile installare la valvola SIMPLE RAPID (non inclusa)
 Doporučuje se použít ventil Simple Rapid (není v ceně)
 Ideal assembly with SIMPLE RAPID valve (This is not included)



Monocomando lavabo

Umyvadlová baterie

Single lever washbasin mixer

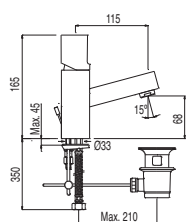

91.34.288

Cr
Nog

1.61.103
1.61.103.60



91.34.288

Cr
Nog

1.66.103
1.66.103.60

Ø45

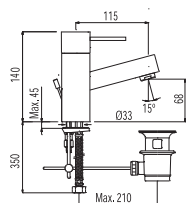

91.34.288

Cr

1.62.103



91.34.288

Cr

1.67.103



Monocomando lavabo
canna lunga

Umyvadlová baterie

Dlouhá výtoková hubice

Single lever washbasin mixer

long spout

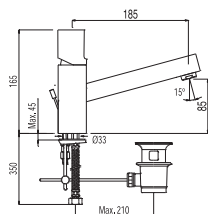

91.34.288

Cr
Nog

1.61.203
1.61.203.60



91.34.288

Cr
Nog

1.66.203
1.66.203.60

Ø45

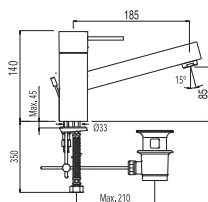

91.34.288

Cr

1.62.203



91.34.288

Cr

1.67.203

MAX-TRES

Ref. / Kód / Nr.:

N



Rubinetto lavabo 1 acqua

Umyvadlová baterie pro studenou nebo smíšenou vodu

Basin pillar tap only cold water

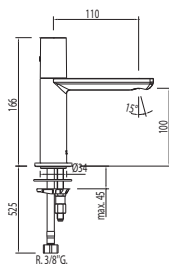

91.34.282

Cr 200.503.01



Monocomando lavabo ecologico

Umyvadlová baterie s ekologickou funkcí

Single lever washbasin mixer ecological

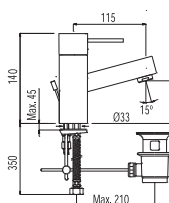

91.34.385.10

Cr 1.62.104.02



91.34.385.10

Cr 1.67.104.02



Lavabo elettronico TOUCH-TRES

Sistema sensibile al tatto. Senza premere.

Baterie s elektronickým řízením TOUCH-TRES

Systém citlivý na dotyk. Za účelem spuštění - dotknout (netlačit)

Electronic wash-basin TOUCH-TRES

Sensitive system to the touch. No press.

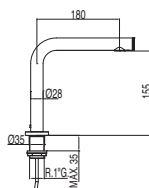

Un'acqua

Pro studenou vodu (nebo vstupně smíšenou)

Only cold water



Ø35

Cr 061.447.01

Brevettato*

Patentovaný*

Patented*



10"

Miscelatore

Se směšovačem

Cold and warm water



Ø35

Cr 061.448.01

Brevettato*

Patentovaný*

Patented*



Lavabo elettronico TOUCH-TRES

Sistema sensibile al tatto. Senza premere.

Baterie s elektronickým řízením TOUCH-TRES

Systém citlivý na dotyk. Za účelem spuštění - dotknout (netlačit)

Electronic wash-basin TOUCH-TRES

Sensitive system to the touch. No press.

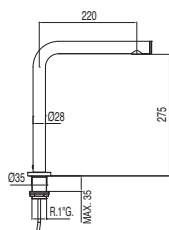

Un'acqua

Pro studenou vodu (nebo vstupně smíšenou)

Only cold water



Ø35 180°

Cr 1.61.445

Brevettato*

Patentovaný*

Patented*

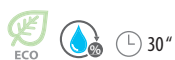

30"

Miscelatore

Se směšovačem

Cold and warm water



Ø35 180°

Cr 1.61.446

Brevettato*

Patentovaný*

Patented*

Ref. / Kód / Nr.:



Rubinetto lavabo 1 acqua

Umyvadlová baterie pro studenou nebo smíšenou vodu

Basin pillar tap only cold water

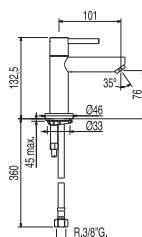

91.34.272.20

Cr

1.62.503



Monocomando lavabo Ø 30 mm.

Umyvadlová baterie Ø 30 mm.

Single lever washbasin mixer Ø 30 mm.

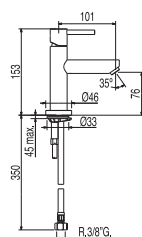

91.62.190

Cr

1.62.603



Monomando a muro

Nastěnná směšovací baterie

Single lever wall washbasin mixer

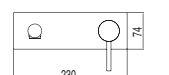
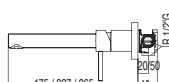

91.34.592

Cr

(16 cm.)
062.200.01



91.34.592

Cr

(21 cm.)
062.200.02



91.34.592

Cr

(25 cm.)
1.62.200



Monomando a muro con bocca a cascata

Nastěnná směšovací baterie s přívalem přítokem

Single lever wall washbasin mixer with cascade cast spout

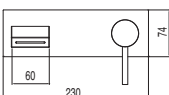
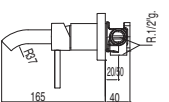

91.34.592

Cr

1.62.260



Canna parete

Stěnová trubice

Wall spout

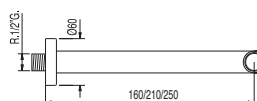

91.34.592

Cr

(16 cm.)
1.61.170.02



91.34.592

Cr

(21 cm.)
061.172.02



91.34.592

Cr

(25 cm.)
1.61.171.02



Bocca a cascata set doccia

Přívalem přítokem vanový set

Cascade cast spout bath mixer

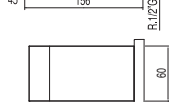
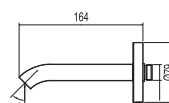

Cr

1.87.181.50



MAX-TRES

Bidet / Bidety / Bidets

Ref. / Kód / Nr.:

N



Monocomando bidet

Bidetová baterie

Single lever bidet mixer

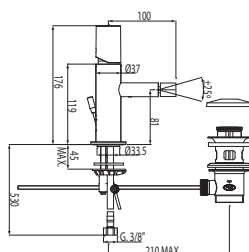

91.07.190.05

Cr

061.120.01



91.07.190.05

Cr

061.120.01.D



91.07.190.05

Cr

062.120.01



91.07.190.05

Cr

062.120.01.D

N



Monocomando bidet

Bidetová baterie

Single lever bidet mixer

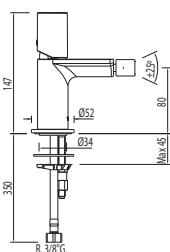

91.30.190

Cr

061.220.01



91.30.190

Cr

061.220.01.D

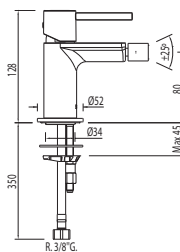

91.30.190

Cr

062.220.01



91.30.190

Cr

062.220.01.D

N



Monocomando bidet

Bidetová baterie

Single lever bidet mixer

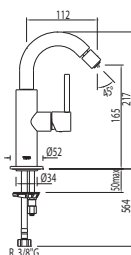

91.30.190

Cr

062.224.02

Cr = Cromo/Chrom/Chrome

Monocomando bidet

Bidetová baterie

Single lever bidet mixer

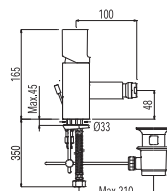

91.34.288

Cr	1.61.120
Nog	1.61.120.60



91.34.288

Cr	1.66.120
Nog	1.66.120.60

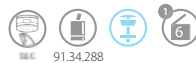
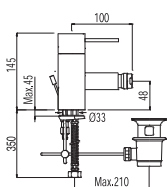

91.34.288

Cr	1.62.120
----	----------



91.34.288

Cr	1.67.120
----	----------



Monocomando ad incasso per bidé WC

Supporto a destra o a sinistra, intercambiabile

Záchodová baterie se směšovačem teplot

Pravý nebo levý podstavec, vyměnitelný

Concealed single lever bidet/toilets

Left or right support, interchangeable

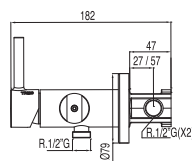

OTTONE
MOSAZ
BRASS



91.34.591

Cr	1.34.123
Cr	1.34.122 *



Monocomando ad incasso per bidé WC

Canna girevole e Flessibile satin

Záchodová baterie se směšovačem teplot

Nástavec ruční sprchy s tlačítkem uzavírajícím vodní proud a hadice satin

Concealed single lever bidet/toilets

Rotating spout satin hose

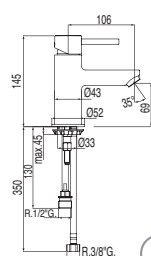

91.34.592.10

Cr	1.62.113
----	----------

Brevettato®
Patentovaný®
Patented®



Monocomando ad incasso per bidé WC

Flessibile satin

Záchodová baterie se směšovačem teplot

Hadice satin

Concealed single lever bidet/toilets

satin hose

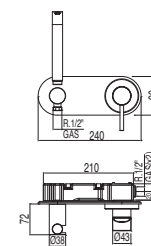

91.34.591

Cr	1.62.123
Cr	1.62.122 *



OTTONE
MOSAZ
BRASS

* Opzione Cartongesso

Možnost pro sádkartonové panely
Optie gips



N



Monocomando bidet con doccetta

Jednopáková baterie se sprškou pro bidet

Bidet mixer tap with small shower head

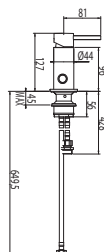

91.34.592

Cr

062.130.01

Monocomandi bagno / Jednopákový mechanismus vany / Bathtub mixer taps

N



Monocomando doccia

Doccia anticalcare (034.116.01). Flessibile satin (91.34.609.15).

Sprchová baterie

Sprchová koncovka se systémem proti tvorbě vodního kamene (034.116.01), hadice satin (91.34.609.15).

Single lever shower mixer

Shower Antilime (034.116.01). Shower hose satin (91.34.609.15).

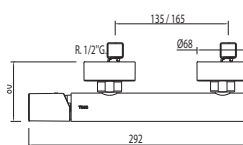

91.30.190



OTTONE
MOSAZ
BRASS

Cr

061.167.01

N



Monocomando vasca

Con bocca a cascata. Doccia anticalcare (034.116.01). Flessibile satin (91.34.609.15).

Vanová baterie

S kaskádou, sprchová koncovka se systémem proti tvorbě vodního kamene (034.116.01), hadice satin (91.34.609.15).

Single lever bath and shower mixer

with cascade. Shower Antilime (034.116.01). Shower hose satin (91.34.609.15).

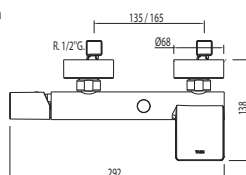

91.30.190



OTTONE
MOSAZ
BRASS

Cr

061.170.01



2 prese da terra per vasca con supporto girevole

2 podlahové přípojky k vanové baterii s otočnou úchytkou

2-outlet bathtub base

With revolving stand

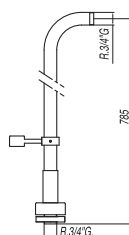

Cr

1.61.194

Ad incasso / Vestavěné / Built-in

Ref. / Kód / Nr.:

N



Monocomando ad incasso doccia
 Podomítková sprchová baterie
Single lever concealed shower mixer

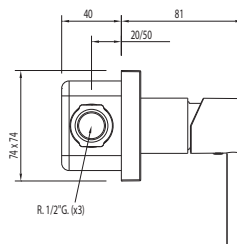

91.30.190

Cr

062.177.02

N



Monocomando incasso bagno doccia con deviatore
 Podomítková vanová baterie s ruční sprchou
Single lever concealed bath and shower mixer

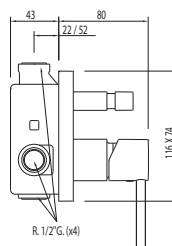

91.30.190

Cr

062.180.02



Monocomando ad incasso doccia
 Podomítková sprchová baterie
Single lever concealed shower mixer

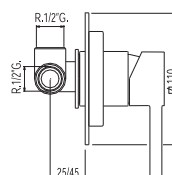

91.34.288

Cr

1.62.177



Monocomando incasso bagno doccia con deviatore
 Podomítková vanová baterie s ruční sprchou
Single lever concealed bath and shower mixer

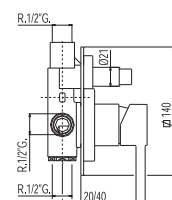

91.34.288

Cr

1.62.180



Distributore 5 vie
 Con chiusura e regolazione di portata
 čtyřcestný přepínač s regulátorem tlaku
5-way diverter
 With water shut off and flow control

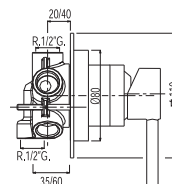

Cr

1.34.550

MAX-TRES

Gruppi ad incasso / Vestavěné soupravy / Built-in sets

Ref. / Kód / Nr.:

N



Kit doccia ad incasso MAX

Con chiusura e regolazione di portata. Doccia fissa da Ø 300 mm. (1.34.137.30). Ottone. Supporto per doccia (299.639.05). Doccia anticalcare (034.116.01). Flessibile satin (91.34.609.15).

Podomítkový set se sprchou MAX

S uzávěrem a regulací průtoku. Hlavová sprcha Ø 300 mm. (1.34.137.30). Mosaz. Pevný držák s vodní přípojkou pro hadici (299.639.05). Ruční sprchy se systémem proti vzniku vodního kamene (034.116.01), hadice satin (91.34.609.15).

Concealed shower set MAX

with water shut off and flow control. Fixed shower head Ø 300 mm. (1.34.137.30). Brass. Elbow wall (299.639.05). Antilime hand shower (034.116.01) and satin hose (91.34.609.15).

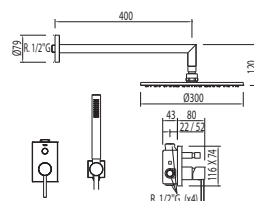

OTTONE
MOSAZ
BRASS



OTTONE
MOSAZ
BRASS



91.30.190

Cr

062.980.01

N



Kit doccia ad incasso MAX

Con chiusura e regolazione di portata. Doccia fissa da 160x550 mm. (299.903.03). Supporto per doccia. (299.639.05). Doccia anticalcare. (034.116.01). Flessibile satin (91.34.609.15).

Podomítkový set se sprchou MAX

S uzávěrem a regulací průtoku. Hlavová sprcha 160x550 mm. (299.903.03). Pevný držák s vodní přípojkou pro hadic. (299.639.05). Sprchová koncovka se systémem proti tvorbě vodního kamene. (034.116.01). Hadice satin (91.34.609.15).

Concealed shower set MAX

with water shut off and flow control. Fixed shower head 160x550 mm. (299.903.03). Elbow wall. (299.639.05). Antilime hand shower. (034.116.01). Satin hose (91.34.609.15).

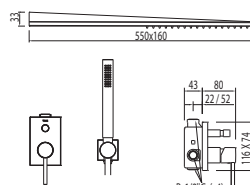

OTTONE
MOSAZ
BRASS



91.30.190

Cr

062.516.01

N



Kit doccia ad incasso MAX

Con chiusura e regolazione di portata. Doccia acciaio inossidabile con cascata 140x203 mm. (299.903.04). Supporto per doccia. (299.639.05). Doccia anticalcare. (034.116.01). Flessibile satin (91.34.609.15).

Podomítkový set se sprchou MAX

S uzávěrem a regulací průtoku. Hlavová sprcha nerezová ocel S kaskádou 140x203 mm. (299.903.04). Pevný držák s vodní přípojkou pro hadic. (299.639.05). Sprchová koncovka se systémem proti tvorbě vodního kamene (034.116.01). Hadice satin (91.34.609.15).

Concealed shower set MAX

with water shut off and flow control. Stainless steel shower with cascade 140x203 mm. (299.903.04). Elbow wall (299.639.05). Antilime hand shower (034.116.01). Satin hose (91.34.609.15).

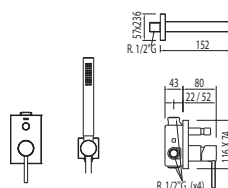

OTTONE
MOSAZ
BRASS



91.30.190

Cr

062.180.05

Cr = Cromo/Chrom/Chrome

Raccomandabile installare la valvola SIMPLE RAPID (non inclusa)
Doporučuje se použít ventil Simple Rapid (není v ceně)
Ideal assembly with SIMPLE RAPID valve (This is not included)

Bordovasca / Vany s prodlouženým pultem / Deck-mounted bathtubs Ref. / Kód / Nr.:

N

°C
 3 bar
 16 l/m

Monocomando bordo vasca
Doccia anticalcareo (034.116.01)
 Vanová 3-otvorová stojánková baterie
 Sprchová koncovka se systémem proti tvorbě
 vodního kamene (034.116.01)
*Bath-shower single lever tap for bracket
 shelf MAX*
with shower antilime (034.116.01)

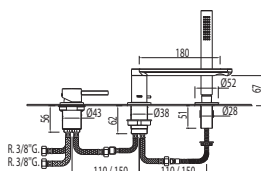

(180 mm)

91.34.591 Cr **062.161.03**



(230 mm)



91.34.591 Cr **062.161.02**

OTTONE
MOSAZ
BRASS

OTTONE
MOSAZ
BRASS

N

Kit bordo vasca
Facile montaggio superiore. Senza registro
 Montážní sada k 3-otvorové baterii s
 odtokem zbytků vody
 Snadná montáž/demontáž seshora.
 Není nutné montovat dodatečné
 revizní prvky u vany
Bath-shower kit cistern
easy upper assembly, without installation

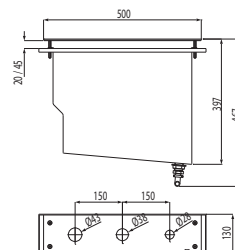

Brevettato[®]
 Patentovaný[®]
 Patented[®]

Cr **203.245.01**

N

°C
 3 bar
 14 l/m

Monocomando bordo vasca
Doccia anticalcareo (034.116.01)
 Vanová 3-otvorová stojánková baterie
 Sprchová koncovka se systémem proti tvorbě
 vodního kamene (034.116.01)
*Bath-shower single lever tap for
 bracket shelf*
with shower antilime (034.116.01)

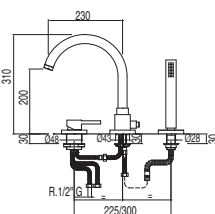

N

Cr **061.150.01**
 Nog **1.61.150.60**



OTTONE
MOSAZ
BRASS

Cr **1.62.150**

N

°C
 3 bar
 17 l/m

Monocomando bordo vasca
Con bocca a cascata, doccia anticalcareo (034.116.01).
 Vanová 3-otvorová stojánková baterie s
 progresivním regulátorem
 S přívalovým vtokem, ruční sprchy se systémem
 proti vzniku vodního kamene (034.116.01).
*Bath-shower single lever
 tap for bracket shelf*
*with cascade cast spout
 and antilime hand
 shower (034.116.01).*

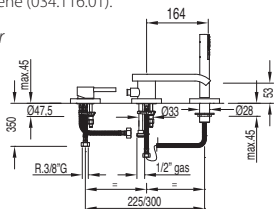

N

Cr **061.161.01**
 Nog **1.61.161.60**



OTTONE
MOSAZ
BRASS

Cr **1.62.161**

N

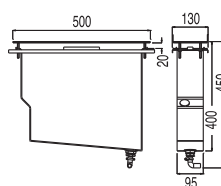

Kit bordo vasca
Facile montaggio superiore. Senza registro
 Montážní sada k 3-otvorové baterii s
 odtokem zbytků vody
 Snadná montáž/demontáž seshora.
 Není nutné montovat dodatečné
 revizní prvky u vany
Bath-shower kit cistern
easy upper assembly, without installation





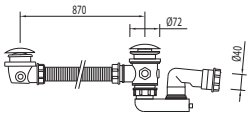

Brevettato[®]
 Patentovaný[®]
 Patented[®]



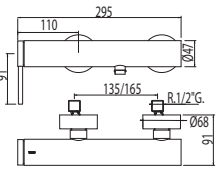

Cr **1.62.245**

MAX-TRES

		Ref. / Kód / Nr.:
	<p>Valvola vasca con presa drenaggio</p> <p>Vanový sifon typu click-clack s přípojkou k odtokovému systému 3-otvorové baterie</p> <p><i>Bath valve with drainage point</i></p>	
		
		Cr 1.34.445

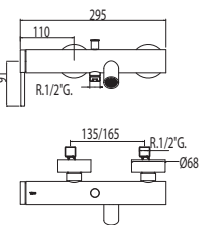
MONO-TERM® Monocomandi bagno / Jednopákový mechanismus vany / Bathtub mixer taps

N	<p>Monocomando doccia</p> <p>Doccia anticalcare (034.116.01). Flessibile satin (91.34.609.15).</p> <p>Sprchová baterie</p> <p>Ruční sprchy se systémem proti vzniku vodního kamene (034.116.01), hadice satin (91.34.609.15).</p> <p><i>Single lever shower mixer</i></p> <p><i>Antilime hand shower (034.116.01) and satin hose (91.34.609.15).</i></p>				OTTONE MOSAZ BRASS
					
				Cr	062.168.01

N	<p>Monocomando vasca</p> <p>Doccia anticalcare (034.116.01). Flessibile satin (91.34.609.15).</p> <p>Vanová baterie</p> <p>Ruční sprchy se systémem proti vzniku vodního kamene (034.116.01), hadice satin (91.34.609.15).</p> <p><i>Single lever bath and shower mixer</i></p> <p><i>Antilime hand shower (034.116.01) and satin hose (91.34.609.15).</i></p>				OTTONE MOSAZ BRASS
					
				Cr	062.178.01

MONO-TERM® Ad incasso / Vestavěné / Built-in

Ref. / Kód / Nr.:

MONO-TERM® da incasso doccia
 Con chiusura e regolazione di portata

 MONO-TERM® k vestavění pro sprchu
 S uzávěrem a regulací průtoku

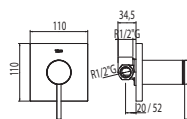
Built-in MONO-TERM® for showers
 With water shut off and flow control

Cr

201.177.01

MONO-TERM® da incasso bagno-doccia
 Con chiusura e regolazione di portata

 MONO-TERM® k vestavění pro vanu-sprchu
 S uzávěrem a regulací průtoku

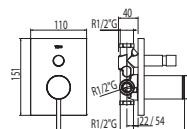
Built-in MONO-TERM® for bathtubs-showers
 With water shut off and flow control

Cr

201.180.01

MONO-TERM® Kit / Set / Set

Ref. / Kód / Nr.:

N

Kit MONO-TERM® da incasso doccia

 Con chiusura e regolazione di portata. Doccia fissa da Ø 300 mm. (1.34.137.30).
 Ottone. Supporto per doccia (299.639.05). Doccia anticalcare (034.116.01).
 Flessibile satin (91.34.609.15).

MONO-TERM® k vestavění pro sprchu

 S uzávěrem a regulací průtoku. Hlavová sprcha Ø 300 mm. (1.34.137.30).
 Mosaz. Pevný držák s vodní přípojkou pro hadici (299.639.05). Ruční sprchy
 se systémem proti vzniku vodního kamene (034.116.01), hadice satin
 (91.34.609.15).

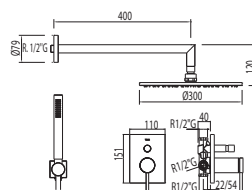
Built-in MONO-TERM® for showers
with water shut off and flow control. Fixed shower head Ø 300 mm. (1.34.137.30). Brass.
Elbow wall (299.639.05). Antilime hand shower (034.116.01) and satin hose (91.34.609.15).

 OTTONE
 MOSAZ
 BRASS

 OTTONE
 MOSAZ
 BRASS

Cr

062.180.03

MAX-TRES

Ref. / Kód / Nr.:



N

Kit MONO-TERM® da incasso doccia
 Con chiusura e regolazione di portata. Doccia acciaio inossidabile con cascata 140x203 mm. (299.903.04). Supporto per doccia. (299.639.05). Doccia anticalcarea. (034.116.01) e tubo flessibile satinato (034.116.01).

MONO-TERM® k vestavění pro sprchu
 S uzávěrem a regulací průtoku. Hlavová sprcha nerezová ocel S kaskádou 140x203 mm. (299.903.04). Pevný držák s vodní přípojkou pro hadic. (299.639.05). Sprchová koncovka se systémem proti tvorbě vodního kamene (034.116.01). Hadice satin (034.116.01).

*Built-in MONO-TERM® for showers
 with water shut off and flow control. Stainless steel shower with cascade 140x203 mm. (299.903.04). Elbow wall (299.639.05). Antilime hand shower (034.116.01). Satin hose (034.116.01).*

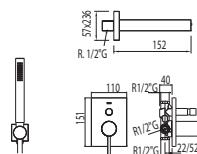

OTTONE
 MOSAZ
 BRASS

Cr 062.180.06



N

Kit MONO-TERM® da incasso doccia
 Con chiusura e regolazione di portata. Doccia fissa da Ø 300 mm. Ottone. (1.34.137.30). Asta antiscivolo lunga 850 mm. (1.34.619). Presa a parete (299.639.06). Doccia anticalcarea. (034.116.01). Flessibile satin. (91.34.609.15).

MONO-TERM® k vestavění pro sprchu
 S uzávěrem a regulací průtoku. Hlavová sprcha Ø 300 mm. Mosaz (1.34.137.30). Posuvná tyč. Délka 850 mm. (1.34.619). Pevný držák s vodní přípojkou pro hadic (299.639.06). Sprchová koncovka se systémem proti tvorbě vodního kamene. (034.116.01). Hadice satin (91.34.609.15).

*Built-in MONO-TERM® for showers
 with water shut off and flow control. Fixed shower head Ø 300 mm. Brass. (1.34.137.30). Bar-shower antilime. long. 850 mm. (1.34.619). Elbow wall (299.639.06). Antilime hand shower (034.116.01) and satin hose (91.34.609.15).*

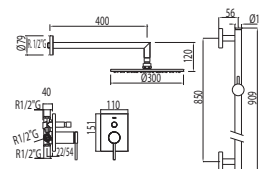

OTTONE
 MOSAZ
 BRASS



OTTONE
 MOSAZ
 BRASS

Cr 062.180.07



N

Kit MONO-TERM® da incasso doccia
 Con chiusura e regolazione di portata. Doccia fissa da Ø 300 mm. Ottone. (1.34.137.30). Doccia anticalcarea. (034.116.01). Flessibile satin. (91.34.609.15). Con presa a parete

MONO-TERM® k vestavění pro sprchu
 S uzávěrem a regulací průtoku. Hlavová sprcha Ø 300 mm. Mosaz (1.34.137.30). Sprchová koncovka se systémem proti tvorbě vodního kamene. (034.116.01). Hadice satin (91.34.609.15). Sprcha se spodní přípojkou vody.

*Built-in MONO-TERM® for showers
 with water shut off and flow control. Fixed shower head Ø 300 mm. Brass. (1.34.137.30). Antilime hand shower (034.116.01) and satin hose (91.34.609.15). With wall entrance*

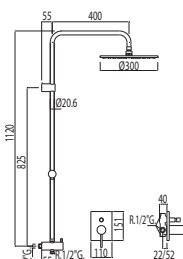

OTTONE
 MOSAZ
 BRASS



OTTONE
 MOSAZ
 BRASS

Cr 062.180.08

Cr = Cromo/Chrom/Chrome

Ref. / Kód / Nr.:

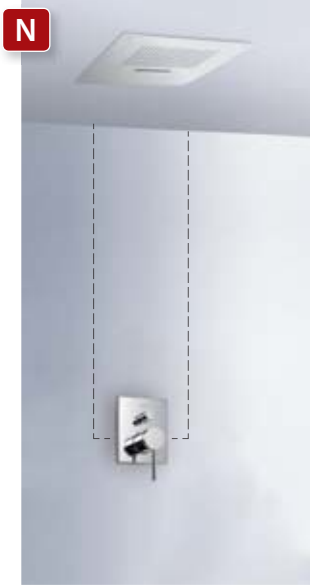

Kit MONO-TERM® da incasso doccia
 Con chiusura e regolazione di portata. Doccia con cascata 280x550 mm. 2 funzioni (299.903.01)

MONO-TERM® k vestavění pro sprchu
 S uzávěrem a regulací průtoku. Hlavová sprcha S kaskádou 280x550 mm. 2 proudy (299.903.01)

*Built-in MONO-TERM® for showers
 with water shut off and flow control. Stainless steel shower with cascade 280x550 mm. 2 positions (299.903.01)*

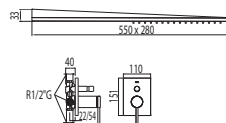

Cr 062.180.04

Kit MONO-TERM® da incasso doccia
 Con chiusura e regolazione di portata. Doccia acciaio inossidabile con cascata 500x500 mm. 2 funzioni (299.516.02).

MONO-TERM® k vestavění pro sprchu
 S uzávěrem a regulací průtoku. Ruční sprcha Kartáčovaná ocel S kaskádou 500x500 mm. 2 proudy (299.516.02).

*Built-in MONO-TERM® for showers
 With water shut off and flow control. Stainless steel shower with cascade 500x500 mm. 2 positions (299.516.02)*

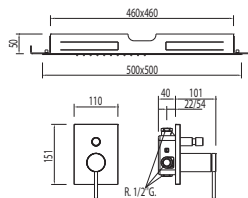

Cr 201.865.01

Kit MONO-TERM®
 Doccia fissa da Ø 300 mm. Ottone (1.34.137.30). Doccia anticalcare (034.116.01). Flessibile satin (91.34.609.15). Asta telescopica.

Sprchový set MONO-TERM®
 Hlavová sprcha Ø 300 mm. Mosaz (1.34.137.30). Ruční sprchy se systémem proti vzniku vodního kamene (034.116.01). Hadice satin (91.34.609.15). Tyč s teleskopickou regulací výšky.

*Bar-shower MONO-TERM® set
 Fixed shower head Ø 300 mm. Brass. (1.34.137.30). Antilime hand shower (034.116.01) and satin hose (91.34.609.15). Telescopic bar.*

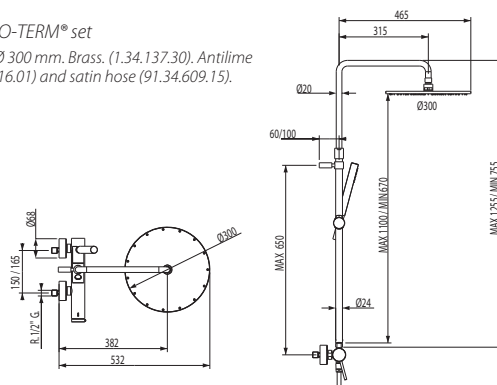

OTTONE
 MOSAZ
 BRASS



OTTONE
 MOSAZ
 BRASS

TRES TOUCH-COOL®

Cr 062.378.01

Cr = Cromo/Chrom/Chrome

MAX-TRES

Termostatiche / Termostatické / Thermostatically-controlled

Ref. / Kód / Nr.:

N



Doccia MAX termostatica

(Doccia anticalcare (034.116.01). Flessibile satin (91.34.609.15)).

Termostatická sprchová baterie MAX

(Ruční sprchy se systémem proti vzniku vodního kamene (034.116.01), hadice satin (91.34.609.15)).

Wall thermostatic shower mixer MAX
(Antilime hand shower (034.116.01) and satin hose (91.34.609.15)).



TRES TOUCH-COOL®

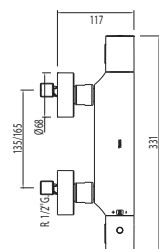

Cr 061.162.01



OTTONE
MOSAZ
BRASS

Cr 061.162.09

N



Vasca-Doccia MAX termostatica

Con bocca a cascata. (Doccia anticalcare (034.116.01). Flessibile satin (91.34.609)).

Termostatická vanová a sprchová baterie MAX

S kaskádou. (Ruční sprchy se systémem proti vzniku vodního kamene (034.116.01), hadice satin (91.34.609)).

Wall thermostatic shower mixer MAX
With cascade. (Antilime hand shower (034.116.01) and satin hose (91.34.609)).



TRES TOUCH-COOL®

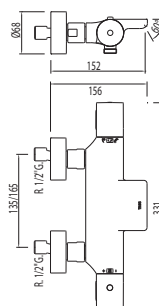

Cr 061.172.01



OTTONE
MOSAZ
BRASS

Cr 061.172.09

Doccia termostatica

Doccia anticalcare (299.631.03). Flessibile satin (91.34.609.15). **Indicato per persone con disabilità fisiche**

Termostatický vanový

Sprchová koncovka se systémem proti tvorbě vodního kamene (299.631.03), hadice satin (91.34.609.15). Ruční sprcha hadice satin. **Určeno pro osoby s fyzickým handicapem**

Wall thermostatic shower mixer

Shower Antilime (299.631.03). Shower hose satin (91.34.609.15). **Suitable for persons with physical disabilities.**



TRES TOUCH-COOL®

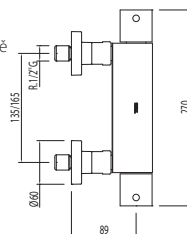

Cr 090.964.01

Vasca-Doccia termostatica

Doccia anticalcare (299.631.03). Flessibile satin (91.34.609). **Indicato per persone con disabilità fisiche**

Termostatická vanová a sprchová baterie

Sprchová koncovka se systémem proti tvorbě vodního kamene (299.631.03), hadice satin (91.34.609). Ruční sprcha hadice satin. **Určeno pro osoby s fyzickým handicapem**

Wall thermostatic shower mixer

Shower Antilime (299.631.03). Shower hose satin (91.34.609). **Suitable for persons with physical disabilities.**



TRES TOUCH-COOL®

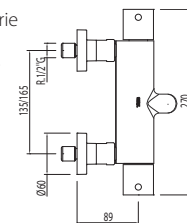

Cr 090.974.01

N



Gomito adattore bagno-doccia

Koleno k vanové baterii

Bath and shower adaptable column

con silenziatore
do zdi s gumovými tlumiči
with silencer

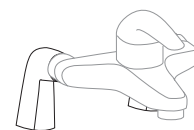
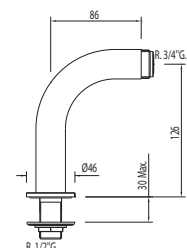

Cr 299.870.01

Cr = Cromo/Chrom/Chrome

N



Set doccia MAX termostatica

Doccia fissa da Ø 300 mm. Ottone (1.34.137.30). Doccia anticalcare (034.116.01). Flessibile satin (91.34.609.15). Invertitore integrato nel regolatore di portata (si veda pagina 576)

Termostatický sprchový set MAX

Hlavová sprcha Ø 300 mm. Mosaz (1.34.137.30). Ruční sprchy se systémem proti vzniku vodního kamene (034.116.01). Hadice satin (91.34.609.15). Přepínač proudů integrovaný s regulátorem tlaku (viz ste 576)

Wall thermostatic shower mixer MAX

Fixed shower head Ø 300 mm. Brass. (1.34.137.30). Antilime hand shower (034.116.01) and satin hose (91.34.609.15). Diverter integrated in the flow control (see page 576)

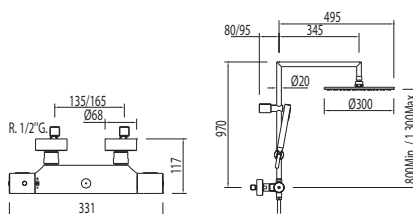

TRES TOUCH-COOL®



OTTONE
MOSAZ
BRASS



OTTONE
MOSAZ
BRASS

Cr 061.393.01

N



Set doccia MAX termostatica

Doccia fissa da Ø 300 mm. Ottone (1.34.137.30). Doccia anticalcare (034.116.01). Flessibile satin (91.34.609.15). Asta telescopica. Invertitore integrato nel regolatore di portata (si veda pagina 576)

Termostatický sprchový set MAX

Hlavová sprcha Ø 300 mm. Mosaz (1.34.137.30). Ruční sprchy se systémem proti vzniku vodního kamene (034.116.01). Hadice satin (91.34.609.15). Tyč s teleskopickou regulací výšky. Přepínač proudů integrovaný s regulátorem tlaku (viz str. 576)

Wall thermostatic shower mixer MAX

Fixed shower head Ø 300 mm. Brass. (1.34.137.30). Antilime hand shower (034.116.01) and satin hose (91.34.609.15). Telescopic bar. Diverter integrated in the flow control (see page 576)

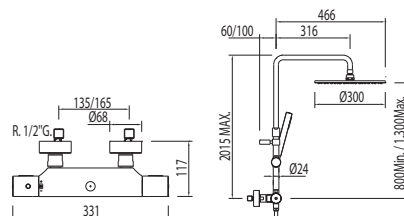

TRES TOUCH-COOL®



OTTONE
MOSAZ
BRASS



OTTONE
MOSAZ
BRASS

Cr 061.210.01



Set doccia MAX termostatica

Doccia fissa da Ø 300 mm. Ottone (1.34.137.30). Doccia anticalcare (034.116.01). Flessibile satin (91.34.609.15). Asta telescopica. Invertitore integrato nel regolatore di portata (si veda pagina 576)

Termostatický sprchový set MAX

Hlavová sprcha Ø 300 mm. Mosaz (1.34.137.30). Ruční sprchy se systémem proti vzniku vodního kamene (034.116.01). Hadice satin (91.34.609.15). Tyč s teleskopickou regulací výšky. Přepínač proudů integrovaný s regulátorem tlaku (viz str. 576)

Wall thermostatic bath mixer MAX

Fixed shower head Ø 300 mm. Brass. (1.34.137.30). Antilime hand shower (034.116.01) and satin hose (91.34.609.15). Telescopic bar. Diverter integrated in the flow control (see page 576)

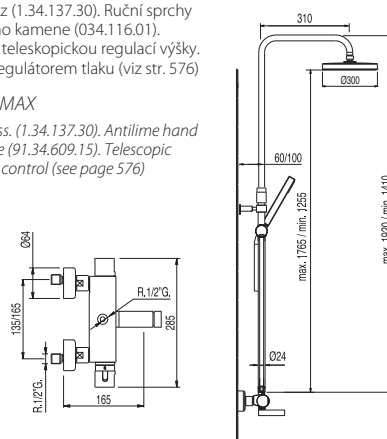

TRES TOUCH-COOL®



OTTONE
MOSAZ
BRASS



OTTONE
MOSAZ
BRASS

Cr 1.90.312

MAX-TRES

Ref. / Kód / Nr.:



N

Kit doccia termostatica MAX

Con chiusura e regolazione di portata. (2 vie) doccia fissa da Ø 300 mm. Ottone (1.34.137.30). Pevný držák s vodní přípojkou pro hadic. (299.639.05). Doccia anticalcarea. (034.116.01). Flessibile satin (91.34.609.15).

Termostatický sprchový set MAX

S uzávěrem a regulací průtoku. (Dvoucestný) Hlavová sprcha Ø 300 mm. Mosaz (1.34.137.30). Pevný držák s vodní přípojkou pro hadic. (299.639.05). Sprchová koncovka se systémem proti tvorbě vodního kamene (034.116.01). Hadice satin (91.34.609.15).

Thermostatic bar-shower MAX

with water shut off and flow control. (2 ways) Fixed shower head Ø 300 mm. Brass (1.34.137.30). Elbow wall (299.639.05). Antilime hand shower (034.116.01). Satin hose (91.34.609.15).

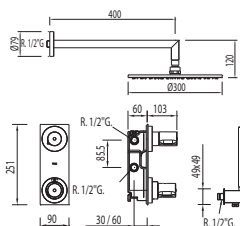

OTTONE
MOSAZ
BRASS



OTTONE
MOSAZ
BRASS



Cr 061.175.02



N

Kit doccia termostatica MAX

Con chiusura e regolazione di portata. (2 vie) doccia acciaio inossidabile da 210x550 mm. (299.903.02). Supporto per doccia. (299.639.05). Doccia anticalcarea. (034.116.01). Flessibile satin (91.34.609.15).

Termostatický sprchový set MAX

S uzávěrem a regulací průtoku. (Dvoucestný) Hlavová sprcha nerezová ocel 210x550 mm. (299.903.02). Pevný držák s vodní přípojkou pro hadic. (299.639.05). Sprchová koncovka se systémem proti tvorbě vodního kamene (034.116.01). Hadice satin (91.34.609.15).

Thermostatic bar-shower MAX

with water shut off and flow control. (2 ways) Stainless steel shower 210x550 mm. (299.903.02). Elbow wall (299.639.05). Antilime hand shower (034.116.01). Satin hose (91.34.609.15).

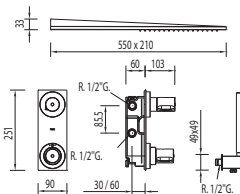

OTTONE
MOSAZ
BRASS



Cr 061.865.01



N

Kit doccia termostatica MAX

Con chiusura e regolazione di portata. (2 vie) Doccia acciaio inossidabile con cascata 140x203 mm. (299.903.04). Supporto per doccia. (299.639.05). Doccia anticalcarea. (034.116.01). Flessibile satin (91.34.609.15).

Termostatický sprchový set MAX

S uzávěrem a regulací průtoku. (Dvoucestný) Hlavová sprcha nerezová ocel S kaskádou 140x203 mm. (299.903.04). Pevný držák s vodní přípojkou pro hadic. (299.639.05). Sprchová koncovka se systémem proti tvorbě vodního kamene (034.116.01). Hadice satin (91.34.609.15).

Thermostatic bar-shower MAX

with water shut off and flow control. (2 ways) Stainless steel shower with cascade 140x203 mm. (299.903.04). Elbow wall (299.639.05). Antilime hand shower (034.116.01). Satin hose (91.34.609.15).

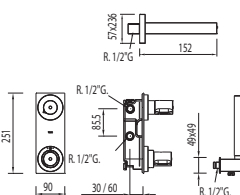

OTTONE
MOSAZ
BRASS



Cr 061.250.05

Cr = Cromo/Chrom/Chrome



N

Kit doccia termostatica MAX

Con chiusura e regolazione di portata. (3 vie) Doccia acciaio inossidabile con cascata 280x550 mm. 2 funzioni (299.903.01). Supporto per doccia. (299.639.05). Doccia anticalcare. (034.116.01). Flessibile satin (91.34.609.15).

Termostatický sprchový set MAX

S uzávěrem a regulací průtoku. (Trojcestný) Hlavová sprcha nerezová ocel S kaskádou 280x550 mm. 2 proudy (299.903.01). Pevný držák s vodní přípojkou pro hadic. (299.639.05). Sprchová koncovka se systémem proti tvorbě vodního kamene. (034.116.01). Hadice satin (91.34.609.15).

Thermostatic bar-shower MAX

with water shut off and flow control. (3 ways) Stainless steel shower with cascade 280x550 mm. 2 positions (299.903.01). Elbow wall. (299.639.05). Antilime hand shower. (034.116.01). Satin hose (91.34.609.15).

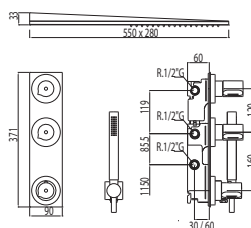

Cr 061.250.06

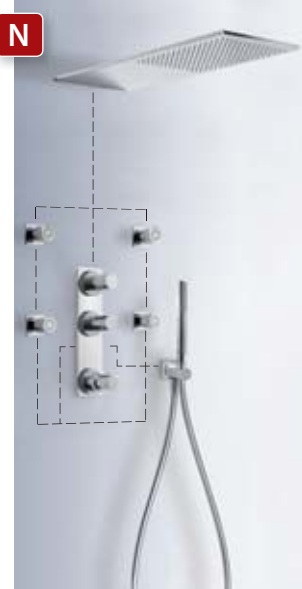

N

Kit doccia termostatica MAX

Con chiusura e regolazione di portata. (3 vie) Doccia acciaio inossidabile da 210x550 mm. (299.903.02). Supporto per doccia. (299.639.05). Doccia anticalcare. (034.116.01). Flessibile satin (91.34.609.15).

Termostatický sprchový set MAX

S uzávěrem a regulací průtoku. (Trojcestný) Hlavová sprcha nerezová ocel 210x550 mm. (299.903.02). Pevný držák s vodní přípojkou pro hadic. (299.639.05). Sprchová koncovka se systémem proti tvorbě vodního kamene (034.116.01). Hadice satin (91.34.609.15).

Thermostatic bar-shower MAX

with water shut off and flow control. (3 ways) Stainless steel shower 210x550 mm. (299.903.02). Elbow wall (299.639.05). Antilime hand shower (034.116.01). Satin hose (91.34.609.15).

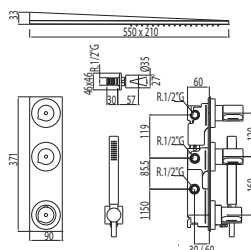

Cr 061.869.01

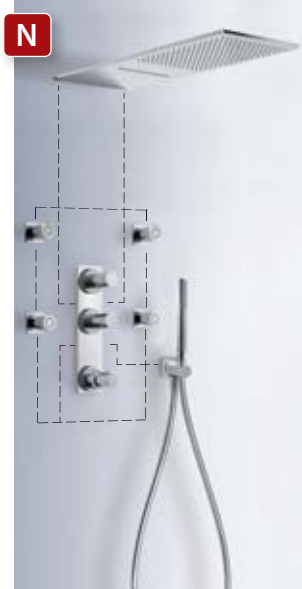

N

Kit doccia termostatica MAX

Con chiusura e regolazione di portata. (4 vie) Doccia acciaio inossidabile con cascata 280x550 mm. 2 funzioni (299.903.01). Supporto per doccia. (299.639.05). Doccia anticalcare. (034.116.01). Flessibile satin (91.34.609.15).

Termostatický sprchový set MAX

S uzávěrem a regulací průtoku. (Čtyřcestný) Hlavová sprcha nerezová ocel S kaskádou 280x550 mm. 2 proudy (299.903.01). Pevný držák s vodní přípojkou pro hadic. (299.639.05). Sprchová koncovka se systémem proti tvorbě vodního kamene. (034.116.01). Hadice satin (91.34.609.15).

Thermostatic bar-shower MAX

with water shut off and flow control. (4 ways) Stainless steel shower with cascade 280x550 mm. 2 positions (299.903.01). Elbow wall. (299.639.05). Antilime hand shower. (034.116.01). Satin hose (91.34.609.15).

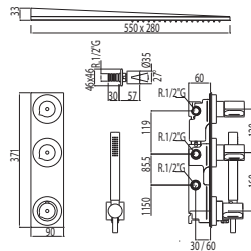

Cr 061.866.01

Cr = Cromo/Chrom/Chrome

MAX-TRES

Ref. / Kód / Nr.:

N

Batteria vasca termostatica MAX

Con bocca a cascata. Supporto per doccia (299.639.05). Doccia anticalcarea. (034.116.01). Flessibile satin (91.34.609).

Termostatická podomítková vanová baterie se sprchou MAX

S přívalovým vtokem. Pevný držák s vodní přípojkou pro hadici (299.639.05). Sprchová koncovka se systémem proti tvorbě vodního kamene. (034.116.01). Hadice satin (91.34.609).

Thermostatic bath MAX

with cascade cast spout. Elbow wall (299.639.05). Antilime hand shower. (034.116.01). Satin hose (91.34.609).

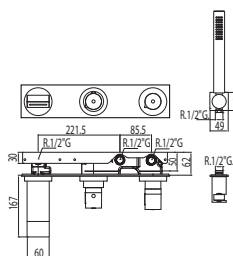

OTTONE
MOSAZ
BRASS



TRES BLOCK-SYSTEM

Cr

061.192.02

Bocca a cascata

Přívalovým přítokem

Cascade cast spout

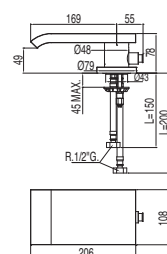

Cr

1.62.161.50

Rubinetti di arresto / Průchozí ventily / Shutoff valves

Ref. / Kód / Nr.:

N

Rubinetto di arresto filettato 1/2"

Ventil se závitem 1/2"

1/2" threaded-ends gate-valve

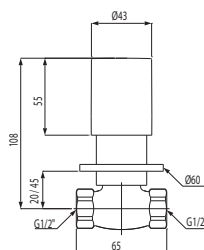

Cr

061.155.01

N

Rubinetto di arresto filettato 3/4"

Ventil se závitem 3/4"

3/4" threaded-ends gate-valve

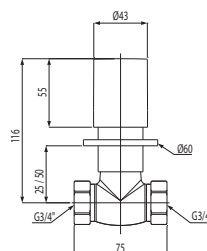

Cr

061.511.01

Cr = Cromo/Chrom/Chrome

Ricambi / Náhradní díly / Spare parts

	Manopola Úchyt Lever				
		Cr	91.34.078		
		Ac	91.34.078.53		
	Volano Otočný ovladač Handle	(per ref. / Kód / for Nr.: 61.103, 66.103, 61.107, 66.107, 61.120, 66.120, 61.150, 61.203, 66.203, 61.207, 66.207, 61.868, 61.874)			
		Cr	91.34.075		
		Nog	91.34.107		
	Volano Lato portata Otočný ovladač na straně regulace proudu vody Handle Flow side	(per ref. / Kód / for Nr.: 90.161, 90.171, 61.155, 61.511, 61.153, 61.154, 61.156, 61.175, 61.176, 61.178, 61.179, 61.182, 61.183, 61.184, 61.185)			
		Cr	91.94.058.02		
		Nog	91.94.107.01		
	Manopola lato temperatura Kohoutek na straně s regulací teploty Temperature side handle	(per ref. / Kód / for Nr.: 61.195, 61.198, 61.395, 61.398, 90.212, 90.312, 90.281, 90.481)			
		Cr	91.94.058.28		
	Cartuccia termostatica + volano Termostatická vložka s otočným ovladačem Thermostatic cartridge stem + Handle	(Per gruppo doccia e bagno doccia) (K vanovým bateriím a vanovým bateriím s ruční sprchou) (For shower, bath and shower mixers)			
		Cr	91.94.161.01		
	Cappuccio Kryt Lid				
		Cr	91.61.103.03		
	Rosone con eccentrico Krycí rozeta s excentrickou spojkou Cover plate + eccentric union				
		Cr	91.61.170.19		
	Invertitore automatico Automatický přepínač Diverter	(per ref. / Kód / for Nr.: 62.150, 62.161, 61.150, 61.161, 61.181)			
		Cr	91.63.147.10		
	Invertitore automatico Automatický přepínač Diverter	(per ref. / Kód / for Nr.: 62.180)			
		Cr	91.62.180.30		
	Supporto doccia Držák sprchy Cover plate and fixing kit	(per ref. / Kód / for Nr.: 61.150, 62.150)			
		Cr	91.62.145.40		
	Aeratore Perlátor Aerator	(per ref. / Kód / for Nr.: 62.503, 62.603) M.18x1			
		Cr	92.62.503		
	Scarico automatico Automatický odtok Pop-up waste	1,1/4"			
		Cr	91.34.275.10		
	Set asta e pulsante Sada přepínače s vedením a úchytem Button and rod set				
		Cr	91.34.275		
	Montaggio ceramica Hlava keramika Cartridge ceramic	(per ref. / Kód / for Nr.: 62.503)			
			91.34.272.20		
	Congiunto bloccaggio Montážní sada Sink mixer locking set				
			96.61.103.01		
	Set fissaggio Montážní sada Locking set				
			91.61.840.10		



LOFT-TRES

200.110.02

LOFT-TRES

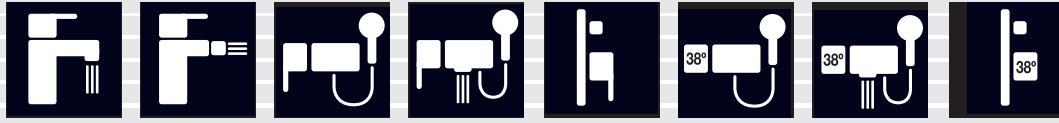



200.170.01



LOFT-TRES



LOFT-TRES





200.174.09



200.180.02

LOFT-TRES

LOFT-TRES

Lavabi / Umyvadla / Basins

Ref. / Kód / Nr.:

Monocomando lavabo

Umyvadlová baterie

Single lever washbasin mixer

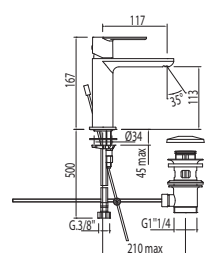
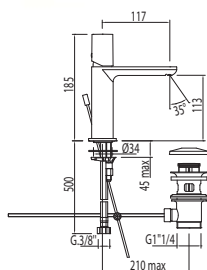

* NOTA: La rubinetteria con canna a cascata è accompagnata da 2 rubinetti di regolazione con filtro (Ref: 91.34.525)

* POZNÁMKA: Baterie typu vodopádu je doplněna dvěma regulačními kohouty s filtrem (Kód.: 91.34.525)

* NOTE: Taps with a cascade spout come with 2 regulation valves and a filter (Nr.: 91.34.525)



91.30.190

Cr

200.103.02



91.30.190

Cr

200.103.02.D



91.30.190

Cr

200.101.02



91.30.190

Cr

200.101.02.D



91.30.190

Cr

200.103.01



91.30.190

Cr

200.103.01.D



91.30.190

Cr

200.101.01



91.30.190

Cr

200.101.01.D

Monocomando lavabo con bocca a cascata aperta

Umyvadlová baterie

výtok otevřená kaskáda

Single lever washbasin mixer

with open cascade spout

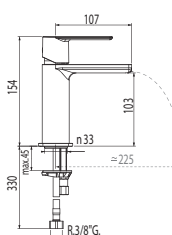
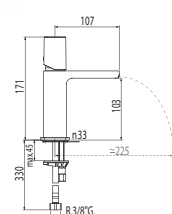

* NOTA: La rubinetteria con canna a cascata è accompagnata da 2 rubinetti di regolazione con filtro (Ref: 91.34.525)

* POZNÁMKA: Baterie typu vodopádu je doplněna dvěma regulačními kohouty s filtrem (Kód.: 91.34.525)

* NOTE: Taps with a cascade spout come with 2 regulation valves and a filter (Nr.: 91.34.525)



91.30.190

Cr

200.110.02



91.30.190

Cr

200.110.01

Cr = Cromo/Chrom/Chrome Nog = Noce/Ořech/Walnut

Raccomandabile installare la valvola SIMPLE RAPID (non inclusa)
Doporučuje se použít ventil Simple Rapid (není v ceně)
Ideal assembly with SIMPLE RAPID valve (This is not included)

LOFT-TRES

Ref. / Kód / Nr.:

Monocomando lavabo
con prolunga inferiore

Umyvadlová baterie

S prodlužkou

Single lever washbasin mixer

with base extension

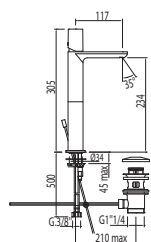
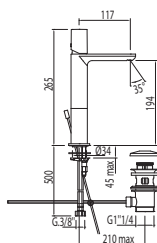
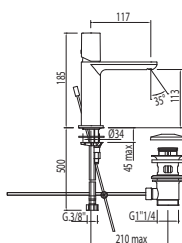
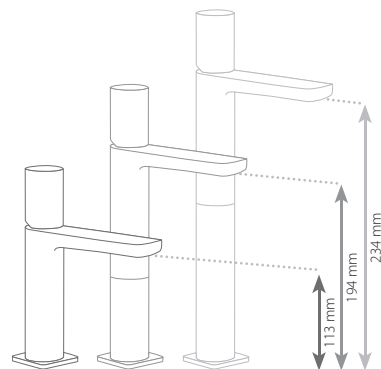

* NOTA: La rubinetteria con canna a cascata è accompagnata da 2 rubinetti di regolazione con filtro (Ref: 91.34.525)

* POZNÁMKA: Baterie typu vodopádu je doplněna dvěma regulačními kohouty s filtrem (Kód: 91.34.525)

* NOTE: Taps with a cascade spout come with 2 regulation valves and a filter (Nr.: 91.34.525)



91.30.190 Cr 200.103.02



91.30.190 Cr 200.103.02.D



91.30.190 Cr 200.101.02



91.30.190 Cr 200.101.02.D



91.30.190 Cr 200.103.04



91.30.190 Cr 200.103.04.D



91.30.190 Cr 200.101.04



91.30.190 Cr 200.101.04.D

Cr = Cromo/Chrom/Chrome Nog = Noce/Ořech/Walnut

Raccomandabile installare la valvola SIMPLE RAPID (non inclusa)
Doporučuje se použít ventil Simple Rapid (není v ceně)
Ideal assembly with SIMPLE RAPID valve (This is not included)

**Monocomando lavabo
con prolunga inferiore**

Umyvadlová baterie

S prodlužkou

Single lever washbasin mixer

with base extension

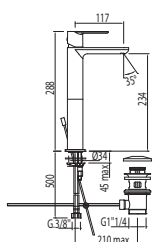
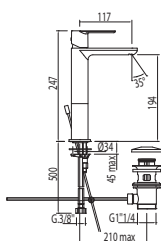
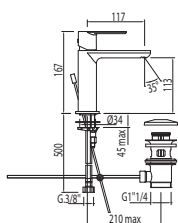

* NOTA: La rubinetteria con canna a cascata è accompagnata da 2 rubinetti di regolazione con filtro (Ref: 91.34.525)

* POZNÁMKA: Baterie typu vodopádu je doplněna dvěma regulačními kohouty s filtrem (Kód.: 91.34.525)

* NOTE: Taps with a cascade spout come with 2 regulation valves and a filter (Nr.: 91.34.525)



91.30.190

Cr

200.103.01



91.30.190

Cr

200.103.01.D



91.30.190

Cr

200.101.01



91.30.190

Cr

200.101.01.D



91.30.190

Cr

200.103.03



91.30.190

Cr

200.103.03.D



91.30.190

Cr

200.101.03



91.30.190

Cr

200.101.03.D



91.30.190

Cr

200.103.05



91.30.190

Cr

200.103.05.D



91.30.190

Cr

200.101.05



91.30.190

Cr

200.101.05.D



LOFT-TRES

Ref. / Kód / Nr.:

Monocomando lavabo
 Umyvadlová baterie
 Single lever washbasin mixer

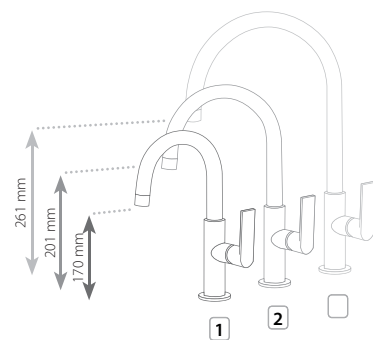

1	91.30.190	Cr	200.205.04
2	91.30.190	Cr	200.205.05
3	91.30.190	Cr	200.205.06

Monocomando lavabo
 canna 35x15 mm.
 Umyvadlová baterie
 Výtoková hubice 35x15 mm.
 Single lever washbasin mixer
 spout 35x15 mm.

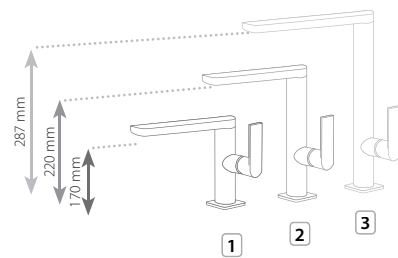

1	91.30.190	Cr	200.205.01
2	91.30.190	Cr	200.205.02
3	91.30.190	Cr	200.205.03



Cr = Cromo/Chrom/Chrome

Raccomandabile installare la valvola SIMPLE RAPID (non inclusa)
 Doporučuje se použít ventil Simple Rapid (není v ceně)
 Ideal assembly with SIMPLE RAPID valve (This is not included)

Ref. / Kód / Nr.:

N



Rubinetto lavabo 1 acqua

Umyvadlová baterie pro studenou nebo smíšenou vodu
Basin pillar tap only cold water

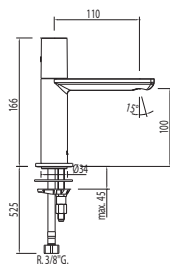

91.34.282

Cr

200.503.01

N



Monomando a muro

Nastěnná směšovací baterie
Single lever wall washbasin mixer

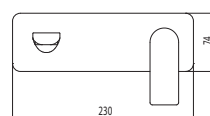
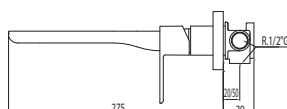

91.30.190

Cr

200.200.02



Monomando a muro con bocca a cascata

Nastěnná směšovací baterie s přívalem přítokem
Single lever wall washbasin mixer with cascade cast spout

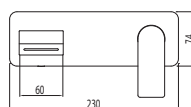
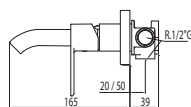

91.30.190

Cr

200.260.01

Bidet / Bidety / Bidets

Ref. / Kód / Nr.:

Monocomando bidet

Bidetová baterie
Single lever bidet mixer

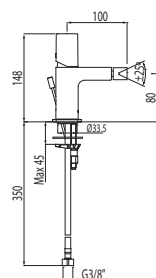

91.30.190

Cr

200.120.02



91.30.190

Cr

200.120.02.D

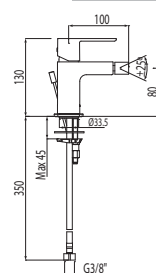

91.30.190

Cr

200.120.01



91.30.190

Cr

200.120.01.D

Cr = Cromo/Chrom/Chrome

LOFT-TRES

Ref. / Kód / Nr.:



Monocomando bidet

Bidetová baterie
Single lever bidet mixer

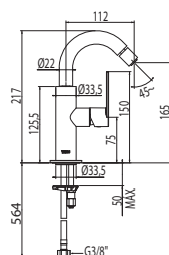

91.30.190

Cr 200.224.01

N



Monocomando bidet con doccia

Jednopáková baterie se sprškou pro bidet
Bidet mixer tap with small shower head

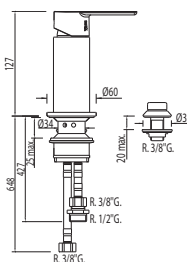

91.34.592

Cr 200.130.01

Monocomandi bagno / Jednopákový mechanizmus vany / Bathtub mixer taps

Ref. / Kód / Nr.:



Monocomando doccia

Doccia anticalcare (034.639.01). flessibile satin (91.34.609.15).

Sprchová baterie
Sprchová koncovka se systémem proti tvorbě vodního kamene (034.639.01), hadice satin (91.34.609.15).

Single lever shower mixer
Shower Antilime (034.639.01).
Shower hose satin (91.34.609.15).

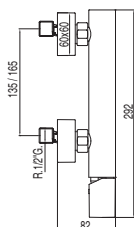

91.30.190

Cr 200.167.01



Monocomando vasca

Con bocca a cascata. Doccia anticalcare (034.639.01). flessibile satin (91.34.609).

Vanová baterie
S kaskádou, sprchová koncovka se systémem proti tvorbě vodního kamene (034.639.01), hadice satin (91.34.609).

Single lever bath and shower mixer with cascade. Shower Antilime (034.639.01). Shower hose satin (91.34.609).

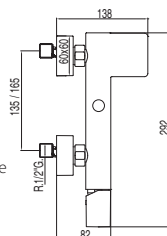

91.30.190

Cr 200.170.01

Cr = Cromo/Chrom/Chrome

Ad incasso / Vestavěné / Built-in

Ref. / Kód / Nr.:



Monocomando ad incasso doccia
 Podomítková sprchová baterie
Single lever concealed shower mixer

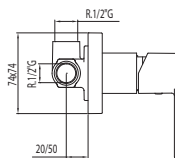

91.30.190

Cr

200.177.01



Monocomando incasso bagno doccia con deviatore
 Podomítková vanová baterie s
 ruční sprchou
*Single lever concealed bath and
 shower mixer*

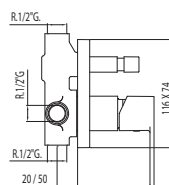

91.30.190

Cr

200.180.01

Gruppi ad incasso / Vestavěné soupravy / Built-in sets

Ref. / Kód / Nr.:



Kit doccia ad incasso LOFT
 Con chiusura e regolazione di portata. Supporto per doccia (1.34.250.01). Doccia
 anticalcare (034.639.01) e flessibile satin (91.34.609.15).

Podomítkový set se sprchou LOFT
 S uzávěrem a regulací průtoku. Pevný držák s vodní přípojkou pro hadici (1.34.250.01).
 Sprchová koncovka se systémem proti tvorbě vodního kamene (034.639.01), hadice satin
 (91.34.609.15).

*Concealed shower set LOFT
 with water shut off and flow control. Elbow wall (1.34.250.01). Antilime hand shower
 (034.639.01) and satin hose (91.34.609.15).*

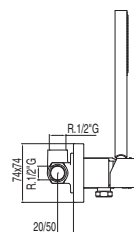

91.30.190

Cr

200.177.02

Ref. / Kód / Nr.:	
-------------------	--



Kit doccia ad incasso LOFT

Con chiusura e regolazione di portata. Doccia fissa da 220x220 mm. (299.632.06). Supporto per doccia (1.34.250.01). Doccia anticalcarea (034.639.01) e flessibile satin (91.34.609.15).

Podomítkový set se sprchou LOFT

S uzávěrem a regulací průtoku. Hlavová sprcha 220x220 mm. (299.632.06). Pevný držák s vodní přípojkou pro hadici (1.34.250.01). Sprchová koncovka se systémem proti tvorbě vodního kamene (034.639.01), hadice satin (91.34.609.15).

Concealed shower set LOFT

with water shut off and flow control. Fixed shower head 220x220 mm. (299.632.06). Elbow wall (1.34.250.01). Antilime hand shower (034.639.01) and satin hose (91.34.609.15).

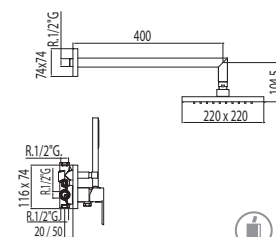

Cr	200.180.02
----	------------



Kit doccia ad incasso LOFT

Con chiusura e regolazione di portata. Doccia fissa da 220x220 mm. (299.632.06). Asta antiscivolo lunga 820 mm. (034.637.01). Angolo presa parete flessibile (1.34.180.01). Doccia anticalcarea (034.639.01) e flessibile satin (91.34.609.15).

Podomítkový set se sprchou LOFT

S uzávěrem a regulací průtoku. Hlavová sprcha 220x220 mm. (299.632.06). Posuvná tyč. Délka 820 mm. (034.637.01). Úhlová přípojka hadice (1.34.180.01). Sprchová koncovka se systémem proti tvorbě vodního kamene (034.639.01), hadice satin (91.34.609.15).

Concealed shower set LOFT

with water shut off and flow control. Fixed shower head 220x220 mm. (299.632.06). Bar-shower antilime long. 820 mm. (034.637.01). Wall elbow adapter for shower hose (1.34.180.01). Antilime hand shower (034.639.01) and satin hose (91.34.609.15).

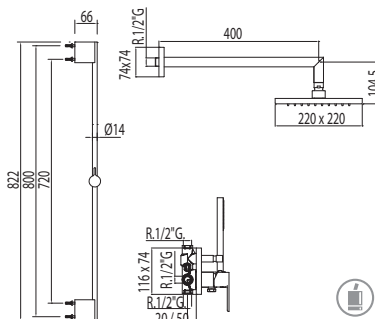

Cr	200.180.03
----	------------

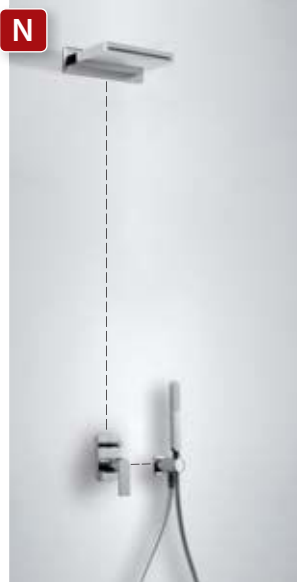

N

Kit doccia ad incasso LOFT

Con chiusura e regolazione di portata. Doccia acciaio inossidabile con cascata 140x203 mm. (299.903.04). Supporto per doccia (1.34.250.01). Doccia anticalcarea (034.639.01) e flessibile satin (91.34.609.15).

Podomítkový set se sprchou LOFT

S uzávěrem a regulací průtoku. Hlavová sprcha nerezová ocel S kaskádou 140x203 mm. (299.903.04). Pevný držák s vodní přípojkou pro hadici (1.34.250.01). Sprchová koncovka se systémem proti tvorbě vodního kamene (034.639.01), hadice satin (91.34.609.15).

Concealed shower set LOFT

with water shut off and flow control. Stainless steel shower with cascade 140x203 mm. (299.903.04). Elbow wall (1.34.250.01). Antilime hand shower (034.639.01) and satin hose (91.34.609.15).

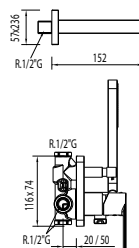

Cr	200.180.04
----	------------

Cr = Cromo/Chrom/Chrome

Bordovasca / Vany s prodlouženým pultem / Deck-mounted bathtubs Ref. / Kód / Nr.:

Monocomando bordo vasca
Doccia anticalcareo (034.639.01)

Vanová 3-otvorová stojánková baterie s progresivním regulátorem
Sprchová koncovka se systémem proti tvorbě vodního kamene (034.639.01)

Bath-shower single lever tap for bracket shelf with shower antilime (034.639.01)

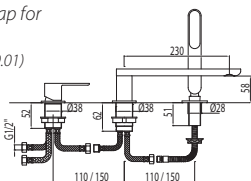

Cr	200.161.01	
----	------------	--



Cr	200.161.02	
----	------------	--

Kit bordo vasca
Facile montaggio superiore. Senza registro

Montážní sada k 3-otvorové baterii s odtokem zbytků vody
Snadná montáž/demontáž seshora. Není nutné montovat dodatečně revizní prvky u vany

Bath-shower kit cistern easy upper assembly, without installation

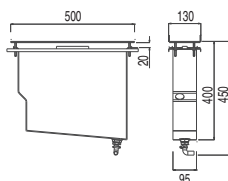

Brevettato[®]
Patentovaný[®]
Patented[®]

Cr	200.245.01	
----	------------	--

Valvola vasca con presa drenaggio

Vanový sifon typu click-clack s přípojkou k odtokovému systému 3-otvorové baterie

Bath valve with drainage point

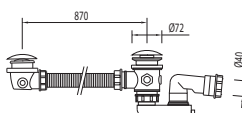

Cr	1.34.445	
----	----------	--

Termostatiche / Termostatické / Thermostatically-controlled Ref. / Kód / Nr.:

Doccia LOFT termostatica
(Doccia anticalcareo (034.639.01). flessibile satin (91.34.609.15)).

Termostatická sprchová baterie LOFT
(Sprchová koncovka se systémem proti tvorbě vodního kamene (034.639.01), hadice satin (91.34.609.15)).

Wall thermostatic shower mixer LOFT (Shower Antilime (034.639.01). Shower hose satin (91.34.609.15)).

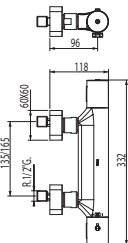

Cr	200.164.01	
----	------------	--



Cr	200.164.09	
----	------------	--

Bagno doccia LOFT termostatica
Con bocca a cascata. (Doccia anticalcareo (034.639.01). flessibile satin (91.34.609)).

Termostatická vanová a sprchová baterie LOFT
S kaskádou. (Sprchová koncovka se systémem proti tvorbě vodního kamene (034.639.01), hadice satin (91.34.609)).

Wall thermostatic bath and shower mixer LOFT with cascade. (Shower Antilime (034.639.01). Shower hose satin (91.34.609)).

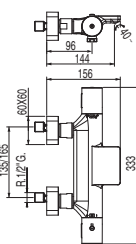

Cr	200.174.01	
----	------------	--



Cr	200.174.09	
----	------------	--

Ref. / Kód / Nr.:



Doccia termostatica
 Doccia anticalcarea (299.631.03). Flessibile satin
 (91.34.609.15). **Indicato per persone con disabilità fisiche**

Termostatický vanový
 Sprchová koncovka se systémem proti tvorbě
 vodního kamene (299.631.03), hadice satin
 (91.34.609.15). Ruční sprcha hadice satin.
Určeno pro osoby s fyzickým handicapem

Wall thermostatic shower mixer
 Shower Antilime (299.631.03). Shower hose
 satin (91.34.609.15). *Suitable for persons with
 physical disabilities.*

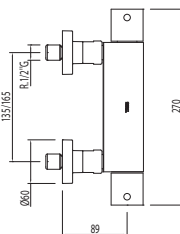

Cr 090.964.01



Vasca-Doccia termostatica
 Doccia anticalcarea (299.631.03). Flessibile satin
 (91.34.609). **Indicato per persone con disabilità fisiche**

Termostatická vanová a sprchová baterie
 Sprchová koncovka se systémem proti
 tvorbě vodního kamene (299.631.03), hadice
 satin (91.34.609). Ruční sprcha hadice satin.
Určeno pro osoby s fyzickým handicapem

Wall thermostatic shower mixer
 Shower Antilime (299.631.03). Shower hose
 satin (91.34.609). *Suitable for persons with
 physical disabilities.*

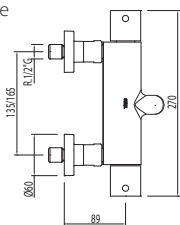

Cr 090.974.01

N



Gomito adattore bagno-doccia
 Koleno k vanové baterii
 Bath and shower adaptable column

con silenziatore
 do zdi s gumovými tlumiči
 with silencer

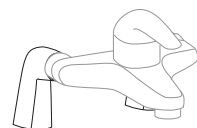
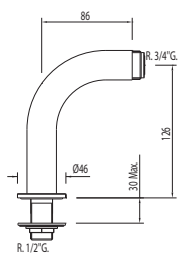

Cr 299.870.01



2 prese da terra per vasca
 con supporto girevole
 2 podlahové přípojky k vanové baterii
 s otočnou úchytkou
 2-outlet bathtub base
 With revolving stand

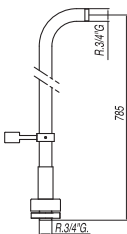

Cr 1.61.194



Doccia LOFT termostatica
 Asta antiscivolo lungo 820 mm. (034.637.01). Doccia anticalcare (034.639.01) e flessibile satin (91.34.609.15).

Termostatická sprchová baterie LOFT
 Posuvná tyč long. 820 mm. (034.637.01). Sprchová koncovka se systémem proti tvorbě vodního kamene (034.639.01), hadice satin (91.34.609.15).

Wall thermostatic shower mixer LOFT
Sliding bar long. 820 mm. (034.637.01). Antilime hand shower (034.639.01) and satin hose (91.34.609.15)



TRES TOUCH-COOL®

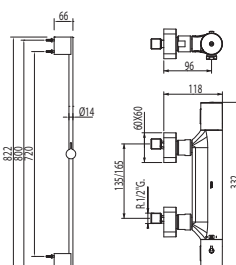

Cr

200.164.02



Bagno doccia LOFT termostatica
 Con bocca a cascata. Asta antiscivolo lungo 820 mm. (034.637.01). Doccia anticalcare (034.639.01) e flessibile satin (91.34.609).

Termostatická vanová a sprchová baterie LOFT s kaskádou. Posuvná tyč long. 820 mm. (034.637.01). Sprchová koncovka se systémem proti tvorbě vodního kamene (034.639.01), hadice satin (91.34.609).

Wall thermostatic bath and shower mixer LOFT with cascade. Sliding bar long. 820 mm. (034.637.01). Antilime hand shower (034.639.01) and satin hose (91.34.609)



TRES TOUCH-COOL®

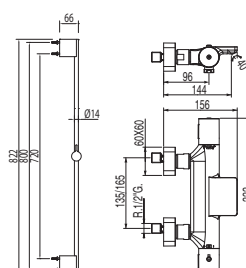

Cr

200.174.02

Gruppi termostatici / Termostatické soupravy / Thermostatically-controlled sets



Set doccia LOFT termostatica

Doccia fissa da 220x220 mm. (299.632.06). Douchette anticalcaire (034.639.01) et flexo satin (91.34.609.15). Asta telescopica. Invertitore integrato nel regolatore di portata (si veda pagina 576)

Termostatický sprchový set LOFT

Hlavová sprcha 220x220 mm. (299.632.06). Ruční sprchy se systémem proti vzniku vodního kamene (034.639.01), hadice satin (91.34.609.15). Tyč s teleskopickou regulací výšky. Přepínač proudů integrovaný s regulátorem tlaku (viz str. 576)

Wall thermostatic shower mixer LOFT

Fixed shower head 220x220 mm. (299.632.06). Antilime hand shower (034.639.01) and satin hose (91.34.609.15). Telescopic bar. Diverter integrated in the flow control (see page 576)

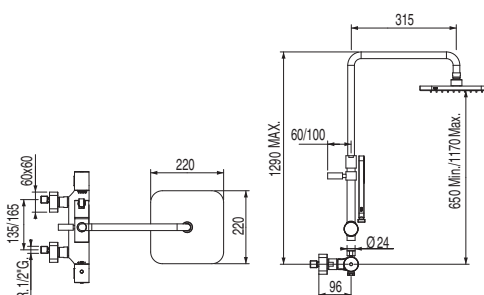

TRES TOUCH-COOL®

Cr

200.195.01



Kit doccia termostatica LOFT

Con chiusura e regolazione di portata. (2 vie) doccia fissa da 220x220 mm. (299.632.06). Supporto per doccia (1.34.250.01). Doccia anticalcarea (1.34.126) e flessibile satin (91.34.609.15).

Termostatický sprchový set LOFT

S uzavěrem a regulací průtoku. (Dvoucestný) Hlavová sprcha 220x220 mm. (299.632.06). Pevný držák s vodní přípojkou pro hadici (1.34.250.01). Sprchová koncovka se systémem proti tvorbě vodního kamene (034.639.01), hadice satin (91.34.609.15).

Thermostatic bar-shower LOFT

with water shut off and flow control. (2 ways) Fixed shower head 220x220 mm. (299.632.06). Elbow wall (1.34.250.01). Antilime hand shower (034.639.01) and satin hose (91.34.609.15).

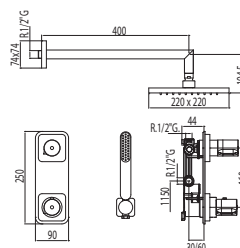

Cr 200.250.05

N



Kit doccia termostatica LOFT

Con chiusura e regolazione di portata. (2 vie) Doccia acciaio inossidabile con cascata 140x203 mm. (299.903.04). Supporto per doccia (1.34.250.01). Doccia anticalcarea (1.34.126) e flessibile satin (91.34.609.15).

Termostatický sprchový set LOFT

S uzavěrem a regulací průtoku. (Dvoucestný) Hlavová sprcha nerezová ocel S kaskádou 140x203 mm. (299.903.04). Pevný držák s vodní přípojkou pro hadici (1.34.250.01). Sprchová koncovka se systémem proti tvorbě vodního kamene (034.639.01), hadice satin (91.34.609.15).

Thermostatic bar-shower LOFT

with water shut off and flow control. (2 ways) Stainless steel shower with cascade 140x203 mm. (299.903.04). Elbow wall (1.34.250.01). Antilime hand shower (034.639.01) and satin hose (91.34.609.15).

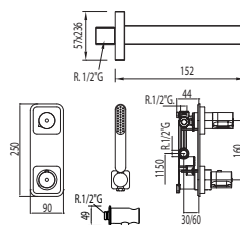

Cr 200.250.12

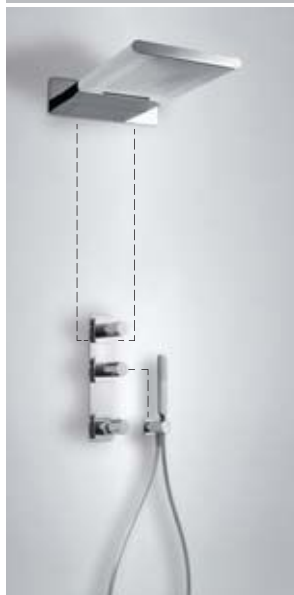

Kit doccia termostatica LOFT

Con chiusura e regolazione di portata. (3 vie) Doccia acciaio inossidabile con cascata 280x550 mm. 2 funzioni (1.34.516.01). Supporto per doccia (1.34.250.01). Doccia anticalcarea (1.34.126) e flessibile satin (91.34.609.15).

Termostatický sprchový set LOFT

S uzavěrem a regulací průtoku. (Trojcestný) Ruční sprcha Kartáčovaná ocel S kaskádou 280x550 mm. 2 proudy (1.34.516.01). Pevný držák s vodní přípojkou pro hadici (1.34.250.01). Sprchová koncovka se systémem proti tvorbě vodního kamene (034.639.01), hadice satin (91.34.609.15).

Thermostatic bar-shower LOFT

with water shut off and flow control. (3 ways) Stainless steel shower with cascade 280x550 mm. 2 positions (1.34.516.01). Elbow wall (1.34.250.01). Antilime hand shower (034.639.01) and satin hose (91.34.609.15).

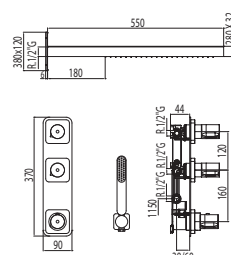

Cr 200.250.08

Cr = Cromo/Chrom/Chrome

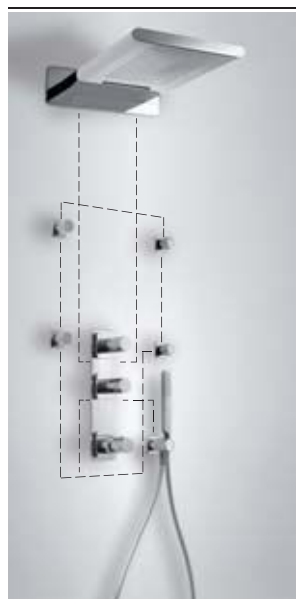
Kit doccia termostatica LOFT

Con chiusura e regolazione di portata. (4 vie) Doccia acciaio inossidabile con cascata 280x550 mm. 2 funzioni (1.34.516.01). Supporto per doccia (1.34.250.01). Doccia anticalcare (1.34.126) e flessibile satin (91.34.609.15).

Termostatický sprchový set LOFT

S uzávěrem a regulací průtoku. (Čtyřcestný) Ruční sprcha Kartáčovaná ocel S kaskádou 280x550 mm. 2 proudy (1.34.516.01). Pevný držák s vodní přípojkou pro hadici (1.34.250.01). Sprchová koncovka se systémem proti tvorbě vodního kamene (034.639.01), hadice satin (91.34.609.15).

Thermostatic bar-shower LOFT

with water shut off and flow control. (4 ways) Shower steel with cascade 280x550 mm. 2 positions (1.34.516.01). Elbow wall (1.34.250.01). Antilime hand shower (034.639.01) and satin hose (91.34.609.15).

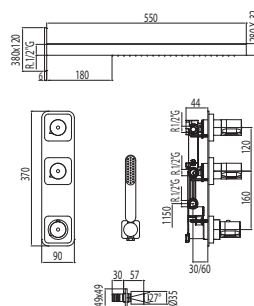

Cr 200.250.09

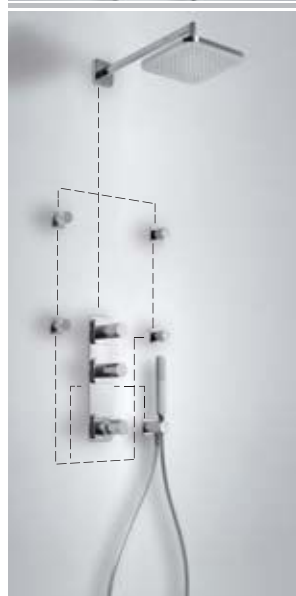
Kit doccia termostatica LOFT

Con chiusura e regolazione di portata. (3 vie) doccia fissa da 220x220 mm. (299.632.06). Supporto per doccia (1.34.250.01). Doccia anticalcare (034.639.01) e flessibile satin (91.34.609.15).

Termostatický sprchový set LOFT

S uzávěrem a regulací průtoku. (Trojcestný) Hlavová sprcha 220x220 mm. (299.632.06). Pevný držák s vodní přípojkou pro hadici (1.34.250.01). Sprchová koncovka se systémem proti tvorbě vodního kamene (034.639.01), hadice satin (91.34.609.15).

Thermostatic bar-shower LOFT

with water shut off and flow control. (3 ways) Fixed shower head 220x220 mm. (299.632.06). Elbow wall (1.34.250.01). Antilime hand shower (034.639.01) and satin hose (91.34.609.15).

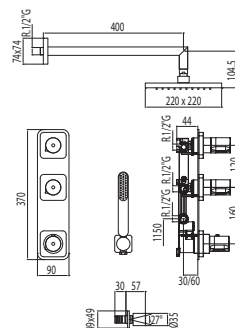

Cr 200.250.07

kit termostatico vasca ad incasso LOFT

Con chiusura e regolazione di portata. (3 vie) doccia fissa da 220x220 mm. (299.632.06). Bec cascade. Supporto per doccia (1.34.250.01). Doccia anticalcare (034.639.01) e flessibile satin (91.34.609.15).

Termostatický podomítkový vanový set s ruční sprchou LOFT

S uzávěrem a regulací průtoku. (Trojcestný) Hlavová sprcha 220x220 mm. (299.632.06). Přívalemý přítokem. Pevný držák s vodní přípojkou pro hadici (1.34.250.01). Sprchová koncovka se systémem proti tvorbě vodního kamene (034.639.01), hadice satin (91.34.609.15).

Concealed thermostatic bath kit LOFT

with water shut off and flow control. (3 ways) Fixed shower head 220x220 mm. (299.632.06). Elbow wall (1.34.250.01). Antilime hand shower (034.639.01) and satin hose (91.34.609.15).

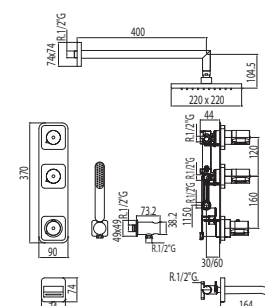

Cr 200.250.11

Ricambi / Náhradní díly / Spare parts

	Manopola Úchyt Lever			
		Cr	299.083.05	
	Volano Otočný ovladač Handle			
		Cr	299.082.04	
	Manopola Úchyt Lever			
		Cr	299.083.07	
	Volano Lato portata Pokreťto regulacji strumienia Handle Flow side			
		Cr	299.082.05	
	Manopola lato temperatura Kohoutek na straně s regulací teploty Temperature side handle			
		Cr	299.082.06	
	Cartuccia termostatica + volano Termostatická vložka s otočným ovládačem Thermostatic cartridge stem + Handle	(per ref. / Kód / for Nr.: 200.164, 200.174)		
		Cr	299.195.03	
	Base per lavabo e bidet Ozdobný kroužek pod umyvadlovou baterii Washbasin mixer base			
			299.084.04	
	Rosone con eccentrico Krycí rozeta s excentric- kou spojkou Cover plate + excentric union			
		Cr	299.084.01	
	Base + rosone Sada rozet Base + cover plate	(per ref. / Kód / for Nr.: 200.177.01, 200.177.02)		
		Cr	299.084.02	
	Base + rosone Sada rozet Base + cover plate	(per ref. / Kód / for Nr.: 200.180.01, 200.180.02, 200.180.03)		
		Cr	299.084.03	
	Rotula Bidetové klouby Ball-and-socket joint bidet mixer			
		Cr	91.07.672	
	Invertitore Přepínač Diverter	(per ref. / Kód / for Nr.: 200.180)		
		Cr	299.553.04	
	Tubo flessibile Spojovací hadička pružná Flexible connection	M.8x100x3/8"		
			299.084.05	
	Rompigetto occulto + rubinetto Skrýty filtr proti postříkání + klíč Hidden water breaker + key	M.24		
		Cr	91.34.668	
	Scarico automatico Automatický odtok Pup-up waste	1,1/4"		
		Cr	91.34.275.10	
	Set asta e pulsante Sada přepínače s vedením a úchytem Button and rod set			
		Cr	91.34.275	
	Cartuccia Řídicí vložka Cartridge stem	Ø 25 mm.		
			91.30.190	
	Madrevite + Chiave multipla Šroub + Víceúčelový klíč Nut + Multipurpose spanner			
		Cr	299.896.02	

CUB-TRES

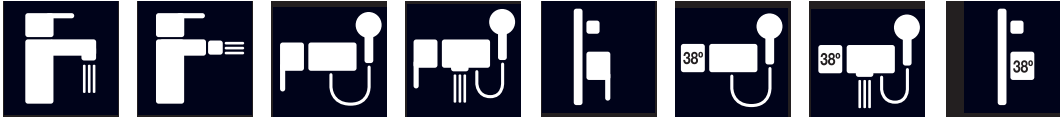



1.87.393

1.87.178

CUB-TRES



1.87.120



1.87.174.9

CUB-TRES

CUB-TRES

Lavabi / Umyvadla / Basins		Ref. / Kód / Nr.:
<p>Monocomando lavabo Umyvadlová baterie Single lever washbasin mixer</p>		
	 	Cr 1.87.103
	 	Cr 1.87.103.DA
	 	Cr 1.89.103
	 	Cr 1.89.103.DA

Bidet / Bidety / Bidets		Ref. / Kód / Nr.:
<p>Monocomando bidet Bidetová baterie Single lever bidet mixer</p>		
	 	Cr 1.87.120
	 	Cr 1.87.120.DA
	 	Cr 1.89.120
	 	Cr 1.89.120.DA

Cr = Cromo/Chrom/Chrome Nog = Noce/Ořech/Walnut

Raccomandabile installare la valvola SIMPLE RAPID (non inclusa)
Doporučuje se použít ventil Simple Rapid (není v ceně)
Ideal assembly with SIMPLE RAPID valve (This is not included)

CUB-TRES

Ad incasso / Vestavěné / Built-in

Ref. / Kód / Nr.:

Monocomando ad incasso doccia

Podomítková sprchová baterie

Single lever concealed shower mixer

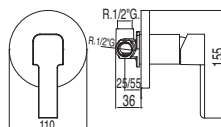

91.34.592

Cr

1.89.177

Monocomando incasso bagno doccia con deviatore

Podomítková vanová baterie s ruční sprchou

Single lever concealed bath and shower mixer

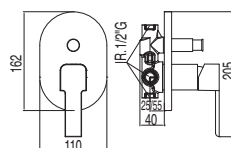

91.34.592

Cr

1.89.180

Gruppi ad incasso / Vestavěné soupravy / Built-in sets

Ref. / Kód / Nr.:

Kit doccia ad incasso CUB

Con chiusura e regolazione di portata. Doccia fissa da 300x300 mm. (1.34.138.30). Ottone.

Podomítkový set se sprchou CUB

S uzávěrem a regulací průtoku. Hlavová sprcha 300x300 mm. (1.34.138.30). Mosaz.

Concealed shower set CUB

with water shut off and flow control. Fixed shower head 300x300 mm. (1.34.138.30) Brass.

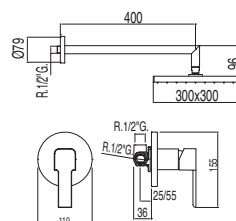

OTTONE
MOSAZ
BRASS



91.34.592

Cr

1.89.377

Cr = Cromo/Chrom/Chrome

Ref. / Kód / Nr.:



kit doccia ad incasso CUB

Con chiusura e regolazione di portata. Doccia fissa da 300x300 mm. (1.34.138.30). Ottone. Supporto per doccia (91.34.182). Doccia anticalcarea (034.116.01). Flessibile satin (91.34.609.15).

Podomítkový set se sprchou CUB

S uzávěrem a regulací průtoku. Hlavová sprcha 300x300 mm. (1.34.138.30). Mosaz. Pevný držák s vodní přípojkou pro hadici (91.34.182). Ruční sprchy se systémem proti vzniku vodního kamene (034.116.01), hadice satin (91.34.609.15).

Concealed shower set CUB

with water shut off and flow control. Fixed shower head 300x300 mm. (1.34.138.30) Brass. Elbow wall (91.34.182). Antilime hand shower (034.116.01) and satin hose (91.34.609.15).

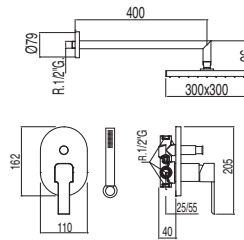

OTTONE
MOSAZ
BRASS



OTTONE
MOSAZ
BRASS



91.34.592

Cr

1.89.980

Bordovasca / Vany s prodlouženým pultem / Deck-mounted bathtubs

Ref. / Kód / Nr.:

Monocomando bordo vasca CUB

Doccia anticalcare (034.116.01).

Vanová 3-otvorová stojánková baterie CUB

Ruční sprchy se systémem proti vzniku vodního kamene (034.116.01).

Bath-shower single lever tap for bracket shelf CUB

Antilime hand shower (034.116.01).



°C
3 bar
14 l/m



BELOGOIA

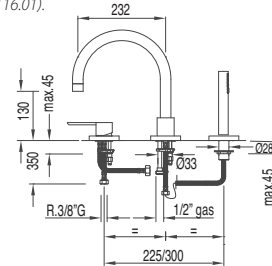

91.34.591

Cr

1.87.150



OTTONE
MOSAZ
BRASS



OTTONE
MOSAZ
BRASS



91.34.591

Cr

1.89.150

Monocomando bordo vasca CUB

Con bocca a cascata. Doccia anticalcare (034.116.01).

Vanová 3-otvorová stojánková baterie CUB

S kaskádou. Ruční sprchy se systémem proti vzniku vodního kamene (034.116.01).

Bath-shower single lever tap for bracket shelf CUB

With cascade. Antilime hand shower (034.116.01).



°C
3 bar
17 l/m



BELOGOIA

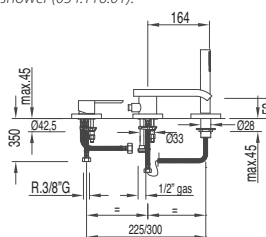

91.34.591

Cr

1.87.161



OTTONE
MOSAZ
BRASS



OTTONE
MOSAZ
BRASS



91.34.591



Cr

1.89.161

Cr = Cromo/Chrom/Chrome

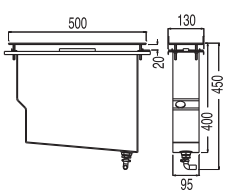
CUB-TRES

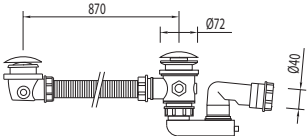
		Ref. / Kód / Nr.:
	<p>Kit bordo vasca Facile montaggio superiore. Senza registro</p> <p>Montážní sada k 3-otvorové baterii s odtokem zbytků vody Snadná montáž/demontáž seshora. Není nutné montovat dodatečné revizní prvky u vany</p> <p><i>Bath-shower kit cistern</i> <i>easy upper assembly, without installation</i></p>	 <div style="border: 1px solid black; padding: 5px; margin-top: 10px;"> <p>Brevettato® Patentovaný® Patented®</p> </div>
		Cr 1.89.245

	<p>Valvola vasca con presa drenaggio</p> <p>Vanový sifon typu click-clack s přípojkou k odtokovému systému 3-otvorové baterie</p> <p><i>Bath valve with drainage point</i></p>	 
		Cr 1.34.445

Termostatiche / Termostatické / Thermostatically-controlled

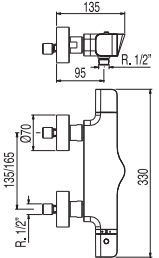
	<p>Doccia Termostatica a parete CUB (Doccia anticalcarea (034.116.01). Flessibile satin (91.34.609.15)).</p> <p>Termostatická sprchová baterie CUB (Ruční sprchy se systémem proti vzniku vodního kamene (034.116.01), hadice satin (91.34.609.15)).</p> <p><i>Wall thermostatic shower mixer CUB</i> <i>(Antilime hand shower (034.116.01) and satin hose (91.34.609.15)).</i></p>		<div style="border: 1px solid gray; padding: 5px; margin-top: 10px;"> <p>Cr 1.87.164</p> </div>
		Cr 1.87.164.9	

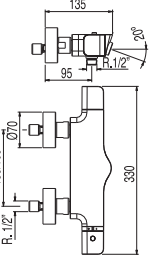
	<p>Vasca-Doccia CUB termostatica (Doccia anticalcare (034.116.01). Flessibile satin (91.34.609)).</p> <p>Termostatická vanová a sprchová baterie CUB (Ruční sprchy se systémem proti vzniku vodního kamene (034.116.01), hadice satin (91.34.609)).</p> <p><i>Wall thermostatic bath and shower mixer CUB</i> <i>(Antilime hand shower (034.116.01) and satin hose (91.34.609)).</i></p>		<div style="border: 1px solid gray; padding: 5px; margin-top: 10px;"> <p>Cr 1.87.174</p> </div>
		Cr 1.87.174.9	

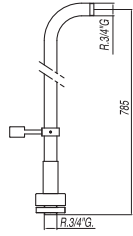
	<p>2 prese da terra per vasca con supporto girevole</p> <p>2 podlahové přípojky k vanové baterii s otočnou úchytkou</p> <p><i>2-outlet bathtub base</i> <i>With revolving stand</i></p>		<div style="border: 1px solid gray; padding: 5px; margin-top: 10px;"> <p>Cr 1.61.194</p> </div>
---	--	---	---

Cr = Cromo/Chrom/Chrome Nog = Noce/Ořech/Walnut



Set doccia CUB termostatica

Doccia fissa da 300x300 mm. Ottone (1.34.138.30). Doccia anticalcarea (034.116.01) e flessibile satin (91.34.609.15). Invertitore integrato nel regolatore di portata (si veda pagina 576)

Termostatický sprchový set CUB

Hlavová sprcha 300x300 mm. Mosaz (1.34.138.30). Ruční sprchy se systémem proti vzniku vodního kamene (034.116.01). Hadice satin (91.34.609.15). Přepínač proudů integrovaný s regulátorem tlaku (viz ste 576)

Wall thermostatic shower mixer CUB

Fixed shower head 300x300 mm. Brass (1.34.138.30). Antilime hand shower (034.116.01) and satin hose (91.34.609.15). Diverter integrated in the flow control (see page 576)

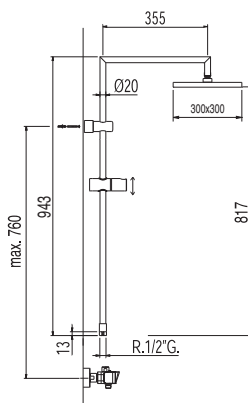

OTTONE
MOSAZ
BRASS



OTTONE
MOSAZ
BRASS



TRES TOUCH-COOL®

Cr 1.87.393



Set doccia CUB termostatica

Doccia fissa da 300x300 mm. Ottone (1.34.138.30). Doccia anticalcarea (034.116.01) e flessibile satin (91.34.609.15). Asta telescopica. Invertitore integrato nel regolatore di portata (si veda pagina 576)

Termostatický sprchový set CUB

Hlavová sprcha 300x300 mm. Mosaz (1.34.138.30). Ruční sprchy se systémem proti vzniku vodního kamene (034.116.01). Hadice satin (91.34.609.15). Tyč s teleskopickou regulací výšky. Přepínač proudů integrovaný s regulátorem tlaku (viz str. 576)

Wall thermostatic shower mixer CUB

Fixed shower head 300x300 mm. Brass (1.34.138.30). Antilime hand shower (034.116.01) and satin hose (91.34.609.15). Telescopic bar. Diverter integrated in the flow control (see page 576)

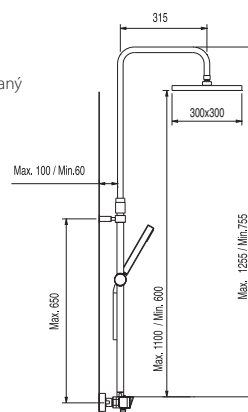

OTTONE
MOSAZ
BRASS



OTTONE
MOSAZ
BRASS



TRES TOUCH-COOL®

Cr 1.87.355



Idrodoccia CUB termostatica con doccia CUB

Doccia fissa da 300x300 mm. Ottone (1.34.138.30). Doccia anticalcarea (034.116.01) e flessibile satin (91.34.609). Asta telescopica. Invertitore integrato nel regolatore di portata (si veda pagina 576)

Termostatický sprchový a vanový set CUB

Hlavová sprcha 300x300 mm. Mosaz (1.34.138.30). Ruční sprchy se systémem proti vzniku vodního kamene (034.116.01). Hadice satin (91.34.609). Tyč s teleskopickou regulací výšky. Přepínač proudů integrovaný s regulátorem tlaku (viz str. 576)

Wall thermostatic bath mixer CUB

Fixed shower head 300x300 mm. Brass (1.34.138.30). Antilime hand shower (034.116.01) and satin hose (91.34.609). Telescopic bar. Diverter integrated in the flow control (see page 576)

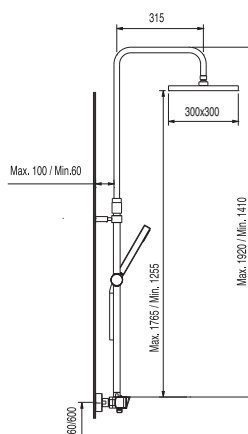

OTTONE
MOSAZ
BRASS



OTTONE
MOSAZ
BRASS



TRES TOUCH-COOL®

Cr 1.87.356



kit termostatico doccia ad incasso CUB

Con chiusura e regolazione di portata. (2 vie) Doccia fissa da 300x300 mm. Ottone (1.34.138.30). Supporto per doccia (91.34.182). Doccia anticalcarea (034.116.01) e flessibile satin (91.34.609.15).

Termostatický podomítkový sprchový set CUB

S uzávěrem a regulací průtoku. (Dvoucestný) Hlavová sprcha 300x300 mm. Mosaz (1.34.138.30). Pevný držák s vodní přípojkou pro hadici (91.34.182). Ruční sprchy se systémem proti vzniku vodního kamene (034.116.01). Hadice satin (91.34.609.15).

Concealed thermostatic shower kit CUB

with water shut off and flow control. (2 ways) Fixed shower head 300x300 mm. Brass (1.34.138.30). Elbow wall (91.34.182). Antilime hand shower (034.116.01) and satin hose (91.34.609.15).

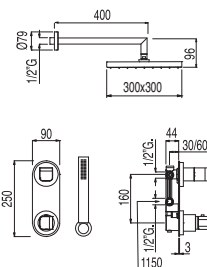

OTTONE
MOSAZ
BRASS



OTTONE
MOSAZ
BRASS



Cr 1.87.175

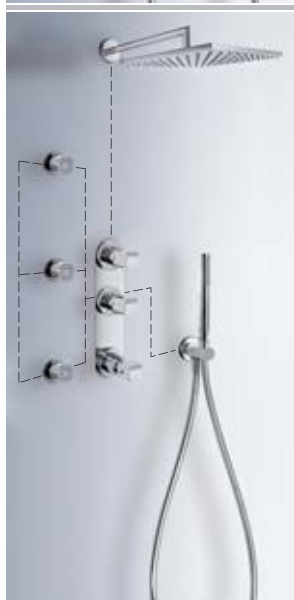

kit termostatico doccia ad incasso CUB

Con chiusura e regolazione di portata. (3 vie) Doccia fissa da 300x300 mm. Ottone (1.34.138.30). Supporto per doccia (91.34.182). 3 jets anticalcare (2 funzioni) (91.34.415). Doccia anticalcarea (034.116.01) e flessibile satin (91.34.609.15).

Termostatický podomítkový sprchový set CUB

S uzávěrem a regulací průtoku. (Trojcestný) Hlavová sprcha 300x300 mm. Mosaz (1.34.138.30). Pevný držák s vodní přípojkou pro hadici (91.34.182). Tři postranní trysky se systémem proti vzniku vodního kamene (2-proudové) (91.34.415). Ruční sprchy se systémem proti vzniku vodního kamene (034.116.01). Hadice satin (91.34.609.15).

Concealed thermostatic shower kit CUB

with water shut off and flow control. (3 ways) Fixed shower head 300x300 mm. Brass (1.34.138.30). Elbow wall (91.34.182). 3 antilime jets, 2 operations (91.34.415). Antilime hand shower (034.116.01) and satin hose (91.34.609.15).

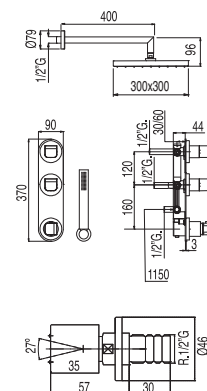

OTTONE
MOSAZ
BRASS



OTTONE
MOSAZ
BRASS



Cr 1.87.178



Kit termostatico vasca ad incasso CUB

Con chiusura e regolazione di portata. (3 vie) Doccia fissa da 300x300 mm. Ottone (1.34.138.30). Supporto per doccia (91.34.182). Con bocca a cascata (1.87.181.50). Doccia anticalcarea (034.116.01) e flessibile satin (91.34.609.15).

Termostatický podomítkový vanový set s ruční sprchou CUB

S uzávěrem a regulací průtoku. (Trojcestný) Hlavová sprcha 300x300 mm. Mosaz (1.34.138.30). Pevný držák s vodní přípojkou pro hadici (91.34.182). Přívalemý přítokem vanový set (1.87.181.50). Ruční sprchy se systémem proti vzniku vodního kamene (034.116.01). Hadice satin (91.34.609.15).

Concealed thermostatic bath kit CUB

with water shut off and flow control. (3 ways) Fixed shower head 300x300 mm. Brass (1.34.138.30). Elbow wall (91.34.182). Cascade cast spout (1.87.181.50). Antilime hand shower (034.116.01) and satin hose (91.34.609.15).

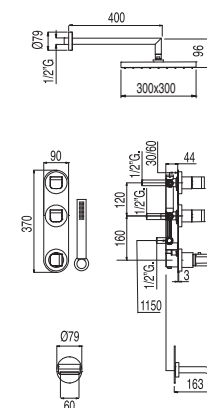

OTTONE
MOSAZ
BRASS



OTTONE
MOSAZ
BRASS



Cr 1.87.144



Batteria vasca termostatica CUB

Con bocca a cascata. Supporto per doccia (91.34.182). Doccia anticalcarea (034.116.01) e flessibile satin (91.34.609).

Termostatická podomítková vanová baterie se sprchou CUB

S přívalovým vtokem. Pevný držák s vodní přípojkou pro hadici (91.34.182).

Ruční sprchy se systémem proti vzniku vodního kamene (034.116.01).

Hadice satin (91.34.609).

Thermostatic bath CUB

with cascade cast spout. Elbow wall (91.34.182).

Antilime hand shower (034.116.01) and satin hose (91.34.609).

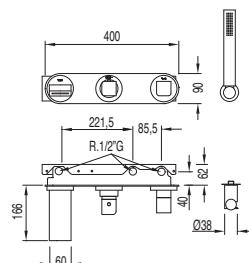

TRES BLOCK-SYSTEM



OTTONE
MOSAZ
BRASS

Cr 1.87.192



Bocca a cascata set doccia

Přívalovým přítokem vanový set

Cascade cast spout bath mixer

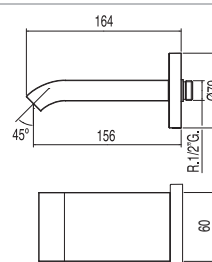

Cr 1.87.181.50



Bocca a cascata

Přívalovým přítokem

Cascade cast spout

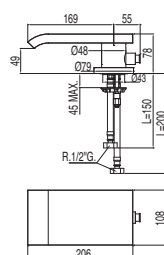

Cr 1.62.161.50

CUB-TRES

Ricambi / Náhradní díly / Spare parts

	Manopola Úchyt Lever				
		Cr	91.34.089		
	Volano Otočný ovladač Handle				
		Cr	91.34.087		
		Nog	91.34.087.60		
	Cartuccia termostatica + volano Termostatická vložka s otočným ovládačem Thermostatic cartridge stem + Handle	(per ref. / Kód / for Nr.: 87.164, 87.174)			
		Cr	91.87.161.10		
		Nog	91.87.161.60		
	Cartuccia termostatica + volano Termostatická vložka s otočným ovládačem Thermostatic cartridge stem + Handle	(per ref. / Kód / for Nr.: 87.250, 87.251, 87.252, 87.253, 87.192.)			
		Cr	91.87.161.50		
		Nog	91.87.161.56		
	Rosone con eccentrico Krycí rozeta s excentrickou spojkou Cover plate + excentric union				
		Cr	91.61.170.19		
	Set sede con valvola antiriforno Hnízdo s ventilem proti zpětnému toku do těles Pipe-flange and anti-reflux valve set	per doccia e vasca termostatica / termostatických vanových a sprchových baterií / for shower and bath thermostatic			
		Cr	91.34.789.03		
	Scarico automatico Automatický odtok Pup-up waste	1,1/4"			
		Cr	91.34.275.10		
	Set asta e pulsante Sada přepínače s vedením a úchytem Button and rod set				
		Cr	91.34.275		
	Cartuccia Řídicí vložka Cartridge stem	Ø 35 mm.			
					91.34.592
	Cartuccia distributore termostatico con due uscite Vložka do dvoucestného přepínače s regulací síly proudu vody Diverter cartridge for 2 way thermostatic				
					91.94.283
	Cartuccia distributore Vložka s přepínačem Distribut cartridge	(per ref. / Kód / for Nr.: 87.135, 87.175, 87.176, 87.178, 87.179, 87.182, 87.183, 87.184, 87.185)			
					91.34.235
	Montaggio Hlava Cartridge	(per ref. / Kód / for Nr.: 87.164)			
					91.34.282
	Invertitore automatico Automatický přepínač Diverter	(per ref. / Kód / for Nr.: 89.180)			
					91.62.180.05



T

1.81.203

LEX-TRES

LEX-TRES

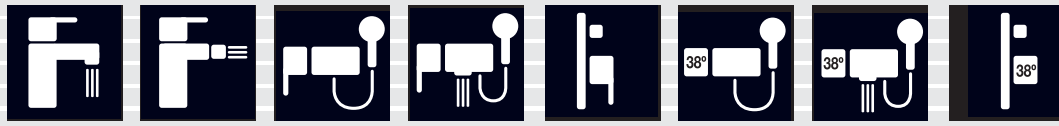



1.81.903



1.81.103

LEX-TRES



1.81.474



1.81.174



1.81.468

LEX-TRES

LEX-TRES

Lavabi / Umyvadla / Basins

Ref. / Kód / Nr.:



Monocomando lavabo

Umyvadlová baterie

Single lever washbasin mixer

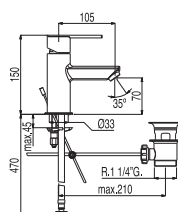

Cr

1.81.103



Cr

1.86.103

Monocomando lavabo

Umyvadlová baterie

Single lever washbasin mixer

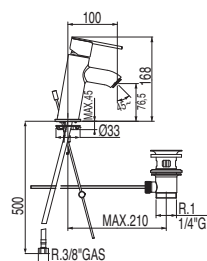

Cr

1.81.903



Cr

1.86.903

LEX-TRES

Ref. / Kód / Nr.:

MISURE SPECIALI / NESTANDARDNÍ ROZMERY / EXCEPTIONAL MEASURES

Monocomando lavabo
con prolunga inferiore

Umyvadlová baterie
S prodlužkou

Single lever washbasin mixer
with base extension

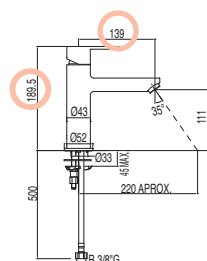
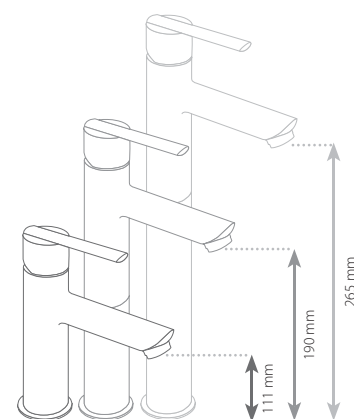
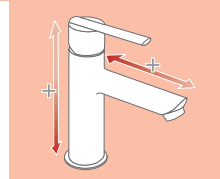

91.34.592

Cr

1.81.203



91.34.592

Cr

1.86.203

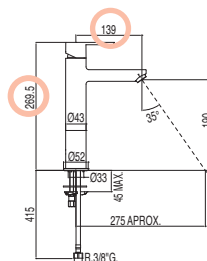

91.34.592

Cr

1.81.217



91.34.592

Cr

1.86.217

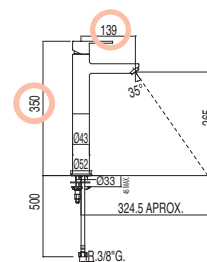

91.34.592

Cr

1.81.207



91.34.592

Cr

1.86.207

Cr = Cromo/Chrom/Chrome

 Raccomandabile installare la valvola SIMPLE RAPID (non inclusa)
Doporučuje se použít ventil Simple Rapid (není v ceně)
Ideal assembly with SIMPLE RAPID valve (This is not included)

Monocomando lavabo

Umyvadlová baterie

Single lever washbasin mixer

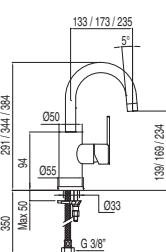
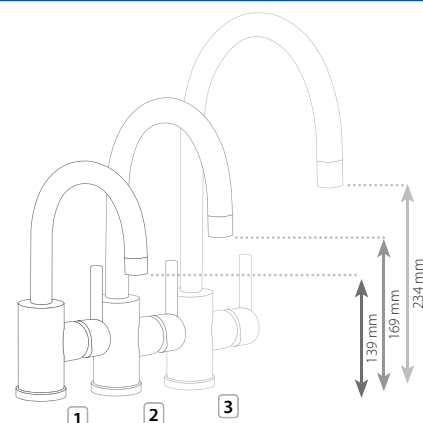

1			Cr	1.81.703
2			Cr	1.81.403
3			Cr	1.81.303



Gruppo lavabo ad appoggio Temporizzata 6,5 l/m.

Pneumatický umyvadlový kohoutek
Časový 6,5 l/m.

Tap from framed washbasin
Temporize 6,5 ltr./m.

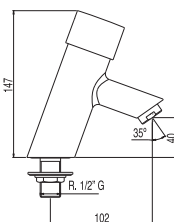

Cr	1.12.203
----	----------



Rubinetto lavabo 1 acqua

Umyvadlová baterie pro studenou nebo
smíšenou vodu

Basin pillar tap only cold water

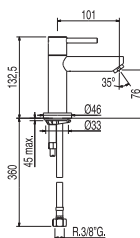

91.34.272.20	Cr	1.62.503
--------------	----	----------



Monocomando lavabo Ø 30 mm.





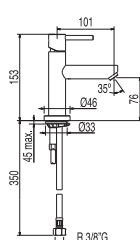



Umyvadlová baterie Ø 30 mm.

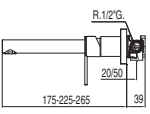

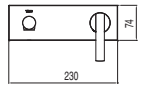



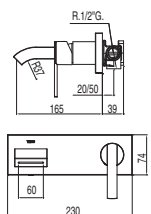

Single lever washbasin mixer Ø 30 mm.

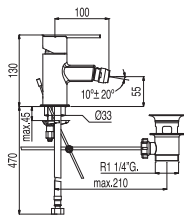

91.62.190	Cr	1.62.603
-----------	----	----------

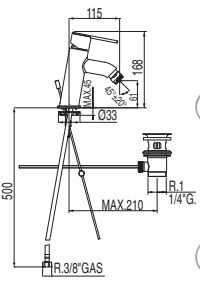
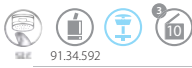
LEX-TRES

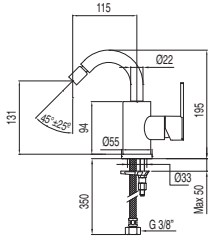
		Ref. / Kód / Nr.:	
	Monomando a muro Nastěnná směšovací baterie <i>Single lever wall washbasin mixer</i>	 R.1/2"G. 175-225-265 20/50 39	 91.34.592 Cr (16 cm.) 081.200.01
		 R.1/2"G. 230	  91.34.592 Cr (21 cm.) 081.200.21
			 91.34.592 Cr (25 cm.) 1.81.200
	Monomando a muro con bocca a cascata Nastěnná směšovací baterie s přívalem přítokem <i>Single lever wall washbasin mixer with cascade cast spout</i>	 R.1/2"G. 165 20/50 39 74 230	 91.34.592 Cr (1.81.260)

Bidet / Bidety / Bidets		Ref. / Kód / Nr.:	
	Monocomando bidet Bidetová baterie <i>Single lever bidet mixer</i>	 100 130 10°±20' 52 033 470 R.1 1/4"G. max.210	 91.34.592 Cr (1.81.120)
	 IA		 91.34.592 Cr (1.86.120)
	Monocomando bidet Bidetová baterie <i>Single lever bidet mixer</i>	 115 108 14 033 500 MAX 210 R.1 1/4"G. R.3/8"GAS	 91.34.592 Cr (1.81.920)
			 91.34.592 Cr (1.86.920)
	Monocomando bidet Bidetová baterie <i>Single lever bidet mixer</i>	 115 022 131 45°±20' 04 055 350 033 Max.50 G.3/8"	 91.34.592 Cr (1.81.224)

Cr = Cromo/Chrom/Chrome

 Raccomandabile installare la valvola SIMPLE RAPID (non inclusa)
 Doporučuje se použít ventil Simple Rapid (není v ceně)
 Ideal assembly with SIMPLE RAPID valve (This is not included)

Ref. / Kód / Nr.:



Monocomando bidet con doccetta

Jednopáková baterie se sprškou pro bidet

Bidet mixer tap with small shower head

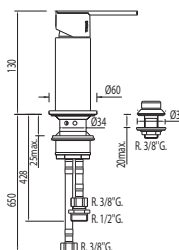

Cr	081.130.01
----	------------



Monocomando ad incasso per bidé WC LEX Supporto a destra o a sinistra, intercambiabile. Flesso satinato

Záchodová baterie se směšovačem teplot LEX
Pravý nebo levý podstavec, vyměnitelný.
Hadice satin

Concealed single lever bidet/toilets LEX

*Left or right support, interchangeable.
Sateen hose*

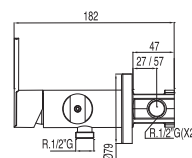

OTTONE
MOSAZ
BRASS



Cr	1.81.223
Cr	1.81.222 *



Monocomando ad incasso per bidé WC LEX Canna girevole e flesso satinato

Záchodová baterie se směšovačem teplot LEX
Nástavec ruční sprchy s tlačítkem uzavírajícím vodní proud a hadice satin

Concealed single lever bidet/toilets LEX

Rotating spout sateen hose

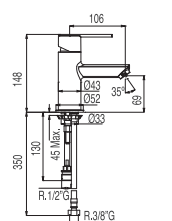

Brevettato °

Patentovaný °

Patented °



Cr	1.81.113
----	----------



Monocomando ad incasso per bidé WC LEX Flesso satinato

Záchodová baterie se směšovačem teplot LEX
Hadice satin

Concealed single lever bidet/toilets LEX

Sateen hose

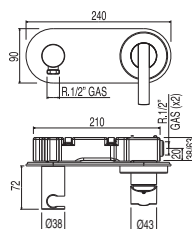

OTTONE
MOSAZ
BRASS



Cr	1.81.123
Cr	1.81.122 *

* Opzione Cartongesso
Možnost pro sádrokartonové panely
Optie gips

Monocomandi bagno / Jednopákový mechanismus vany / Bathtub mixer taps

Ref. / Kód / Nr.:



Monocomando doccia

Doccia mobile Ø 100 mm. (5 funzioni)
(1.34.748) e flessibile satin (91.34.609.15).

Sprchová baterie

Masážní ruční sprcha Ø 100 mm
(5 proudy) (1.34.748) a hadicí satin
(91.34.609.15).

Single lever shower mixer

*Massage hand shower Ø 100 mm.
(5 fonctions) (1.34.748) and satin
hose (91.34.609.15).*

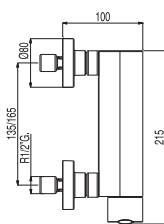

Cr	1.81.468
----	----------

Cr = Cromo/Chrom/Chrome

Raccomandabile installare la valvola SIMPLE RAPID (non inclusa)
Doporučuje se použít ventil Simple Rapid (není v ceně)
Ideal assembly with SIMPLE RAPID valve (This is not included)

LEX-TRES

Ref. / Kód / Nr.:



Monocomando vasca
 Doccia mobile Ø 100 mm. (5 funzioni)
 (1.34.748) e flessibile satin (91.34.609).

Vanová baterie
 Masážní ruční sprcha Ø 100 mm
 (5 proudy) (1.34.748) a hadicí satin
 (91.34.609).

Single lever bath and shower mixer
 Massage hand shower Ø 100 mm.
 (5 fonctions) (1.34.748) and satin
 hose (91.34.609).

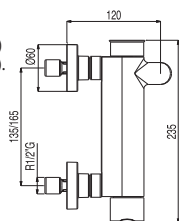

91.34.592

Cr

1.81.474



Set doccia LEX

Doccia fissa Ø 225 mm. (299.632.01). Doccia mobile Ø 100 mm. (5 funzioni)
 (1.34.748) e flessibile satin (91.34.609.15).

Podomítkový set se sprchou LEX

Hlavová sprcha Ø 225 mm. (299.632.01). Masážní ruční sprcha Ø 100 mm
 (5 proudy) (1.34.748) a hadicí satin (91.34.609.15).

Bar-shower LEX set

*Fixed shower head Ø 225 mm. (299.632.01). Massage hand shower Ø 100 mm.
 (5 fonctions) (1.34.748) and satin hose (91.34.609.15).*

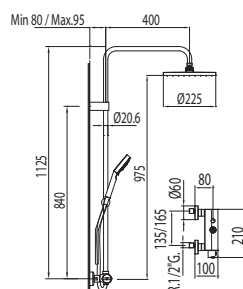

91.34.592

Cr

1.81.191



Ad incassio / Vestavěné / Built-in

Ref. / Kód / Nr.:



Monocomando ad incasso doccia

Podomítková sprchová baterie

Single lever concealed shower mixer

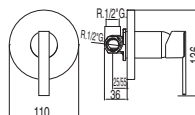

91.34.592

Cr

1.81.177.05



Monocomando incasso bagno doccia con deviatore

Podomítková vanová baterie s
 ruční sprchou

*Single lever concealed bath and
 shower mixer*

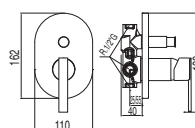

91.34.592

Cr

1.81.180.05

Cr = Cromo/Chrom/Chrome

Kit doccia ad incasso LEX

Con chiusura e regolazione di portata. Doccia fissa da Ø 250 mm. (1.34.137.26).

Podomítkový set se sprchou LEX

S uzávěrem a regulací průtoku. Hlavová sprcha Ø 250 mm. (1.34.137.26).

Concealed shower set LEX

with water shut off and flow control. Fixed shower head Ø 250 mm. (1.34.137.26).

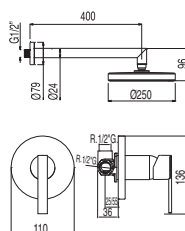

91.34.592

Cr

1.81.377.05

Kit doccia ad incasso LEX

Con chiusura e regolazione di portata. Doccia fissa da Ø 250 mm. (1.34.137.26).

Supporto per doccia (91.34.182). Doccia mobile Ø 100 mm. (5 funzioni) (1.34.748) e flessibile satin (91.34.609.15).

Podomítkový set se sprchou LEX

S uzávěrem a regulací průtoku. Hlavová sprcha Ø 250 mm. (1.34.137.26). Pevný držák s vodní přípojkou pro hadici (91.34.182). Masážní ruční sprcha Ø 100 mm (5 proudy) (1.34.748) a hadicí satin (91.34.609.15).

Concealed shower set LEX

with water shut off and flow control. Fixed shower head Ø 250 mm. (1.34.137.26). Elbow wall (91.34.182). Massage hand shower Ø 100 mm. (5 functions) (1.34.748) and satin hose (91.34.609.15).

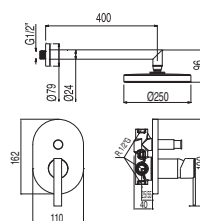

91.34.592

Cr

1.81.880.05

Kit doccia ad incasso LEX

Con chiusura e regolazione di portata. Doccia fissa da Ø 250 mm. (1.34.137.26).

Asta antiscivolo lunga 550 mm. (1.34.618). Presa a parete (1.34.758). Doccia mobile Ø 100 mm. (5 funzioni) (1.34.748) e flessibile satin (91.34.609.15).

Podomítkový sprchový set LEX

S uzávěrem a regulací průtoku. Hlavová sprcha Ø 250 mm. (1.34.137.26). Posuvná tyč. Délka 550 mm. (1.34.618). Pevný držák s vodní přípojkou pro hadici (1.34.758) Masážní ruční sprcha Ø 100 mm (5 proudy) (1.34.748) a hadicí satin (91.34.609.15).

Concealed shower kit LEX

with water shut off and flow control. Fixed shower head Ø 250 mm. (1.34.137.26). Bar-shower antislime. long. 550 mm. (1.34.618). Elbow wall (1.34.758). Massage hand shower Ø 100 mm. (5 functions) (1.34.748) and satin hose (91.34.609.15).

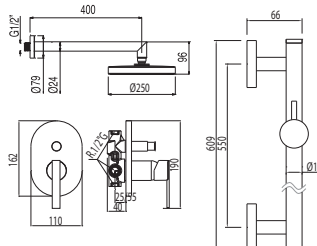

91.34.592

Cr

081.980.06

LEX-TRES

Bordovasca / Vany s prodlouženým pultem / Deck-mounted bathtubs

Ref. / Kód / Nr.:

N

Monocomando bordo vasca
Doccia mobile massaggio Ø 100 mm. (5 funzioni)
(1.34.748).

Vanová 3-otvorová stojánková baterie
Masážní ruční sprcha Ø 100 mm (5 proudy)
(1.34.748).
Bath-shower single lever tap for bracket shelf
Massage hand shower Ø 100 mm. (5 fonctions)
(1.34.748).

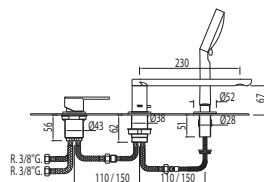

3 bar
16 l/m



91.34.591

Cr 081.161.03

N

Kit bordo vasca
Facile montaggio superiore. Senza registro

Montážní sada k 3-otvorové baterii s odtokem zbytků vody
Snadná montáž/demontáž seshora.
Není nutné montovat dodatečné revizní prvky u vany

Bath-shower kit cistern
easy upper assembly, without installation

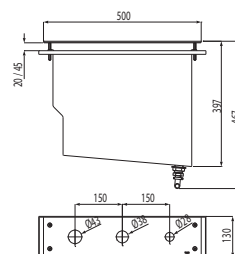

Brevettato®
Patentovaný®
Patented®

Cr 203.245.01

Monocomando bordo vasca
Doccia mobile massaggio Ø 100 mm. (5 funzioni)
(1.34.748).

Vanová 3-otvorová stojánková baterie
Masážní ruční sprcha Ø 100 mm (5 proudy)
(1.34.748).
Bath-shower single lever tap for bracket shelf
Massage hand shower Ø 100 mm. (5 fonctions)
(1.34.748).

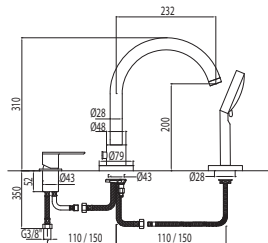

3 bar
14 l/m

Cr 081.150.01

N

Kit bordo vasca
Facile montaggio superiore. Senza registro

Montážní sada k 3-otvorové baterii s odtokem zbytků vody
Snadná montáž/demontáž seshora.
Není nutné montovat dodatečné revizní prvky u vany

Bath-shower kit cistern
easy upper assembly, without installation

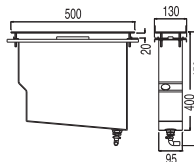

Brevettato®
Patentovaný®
Patented®

Cr 1.89.245

Valvola vasca con presa drenaggio
Vanový sifon typu click-clack s přípojkou k odtokovému systému 3-otvorové baterie

Bath valve with drainage point

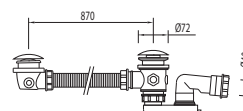

Cr 1.34.445

Cr = Cromo/Chrom/Chrome

MONO-TERM® Monocomandi bagno / Jednopákový mechanismus vany / Bathtub mixer taps

Ref. / Kód / Nr.:

MONO-TERM® doccia
 Doccia mobile Ø 100 mm. (5 funzioni) (1.34.748)
 e flessibile satin (91.34.609.15).

MONO-TERM® Sprchová baterie
 Masážní ruční sprcha Ø 100 mm (5 proudy)
 (1.34.748) a hadicí satin (91.34.609.15).

MONO-TERM® Single lever shower mixer
 Massage hand shower Ø 100 mm. (5 fonctions)
 (1.34.748) and satin hose (91.34.609.15).

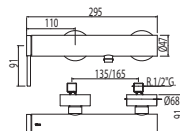

TRES TOUCH-COOL®

Cr 201.167.01

MONO-TERM® vasca
 Doccia mobile Ø 100 mm. (5 funzioni) (1.34.748)
 e flessibile satin (91.34.609).

MONO-TERM® Vanová baterie
 Masážní ruční sprcha Ø 100 mm (5 proudy)
 (1.34.748) a hadicí satin (91.34.609).

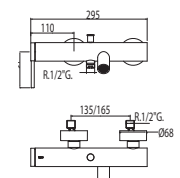
MONO-TERM® Single lever bath and
 shower mixer
 Massage hand shower Ø 100 mm. (5 fonctions)
 (1.34.748) and satin hose (91.34.609).

TRES TOUCH-COOL®

Cr 201.170.01

MONO-TERM® Ad incassio / Vestavěné / Built-in

Ref. / Kód / Nr.:

MONO-TERM® da incasso doccia
 Con chiusura e regolazione di portata

MONO-TERM® k vestavění pro sprchu

S uzávěrem a regulací průtoku

Built-in MONO-TERM® for showers

With water shut off and flow control

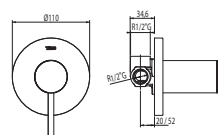

Cr 201.177.02

MONO-TERM® da incasso bagno-doccia
 Con chiusura e regolazione di portata

MONO-TERM® k vestavění pro vanu-sprchu

S uzávěrem a regulací průtoku

Built-in MONO-TERM® for bathtubs-showers

With water shut off and flow control

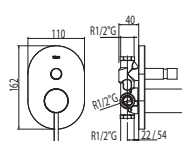

Cr 201.180.02

LEX-TRES

MONO-TERM® Kit / Set / Set

Ref. / Kód / Nr.:



Kit MONO-TERM® da incasso doccia

Con chiusura e regolazione di portata. Doccia fissa Ø 225 mm. (299.632.01). Doccia mobile Ø 100 mm. (5 funzioni) (1.34.748) e flessibile satin (91.34.609.15). Con presa a parete

MONO-TERM® k vestavění pro sprchu

S uzavěrem a regulací průtoku. Hlavová sprcha Ø 225 mm. (299.632.01). Regulovaná sprcha Ø 100 mm. (5 proudy) (1.34.748). Hadice satin (91.34.609.15). Sprcha se spodní přípojkou vody.

Built-in MONO-TERM® for showers

With water shut off and flow control. Fixed shower head Ø 225 mm. (299.632.01). Massage hand shower Ø 100 mm. (5 functions) (1.34.748) and satin hose (91.34.609). With wall entrance

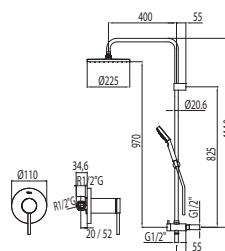

Cr 201.177.03



Kit MONO-TERM® da incasso doccia

Con chiusura e regolazione di portata. Doccia fissa da Ø 250 mm. (1.34.137.26). Supporto per doccia (91.34.182). Doccia mobile Ø 100 mm. (5 funzioni) (1.34.748) e flessibile satin (91.34.609.15).

MONO-TERM® k vestavění pro sprchu

S uzavěrem a regulací průtoku. Hlavová sprcha Ø 250 mm. (1.34.137.26). Pevný držák s vodní přípojkou pro hadici (91.34.182). Regulovaná sprcha Ø 100 mm. (5 proudy) (1.34.748). Hadice satin (91.34.609.15).

Built-in MONO-TERM® for showers

With water shut off and flow control. Fixed shower head Ø 250 mm. (1.34.137.26). Elbow wall (91.34.182). Massage hand shower Ø 100 mm. (5 functions) (1.34.748) and satin hose (91.34.609).

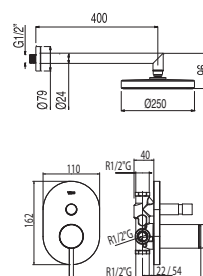

Cr 201.180.03



Kit MONO-TERM®

Doccia fissa Ø 250 mm. (1.34.137.26). Doccia mobile massaggio Ø 100 mm. (5 funzioni) (1.34.748) Flessibile satin (91.34.609.15). Asta telescopica.

Sprchový set MONO-TERM®

Hlavová sprcha Ø 250 mm. (1.34.137.26). Masážní ruční sprcha Ø 100 mm (5 proudy) (1.34.748). Hadice satin (91.34.609.15). Tyč s teleskopickou regulací výšky.

Bar-shower MONO-TERM® set

Fixed shower head Ø 250 mm. (1.34.137.26). Massage hand shower Ø 100 mm. (5 functions) (1.34.748) and satin hose (91.34.609.15). Telescopic bar.

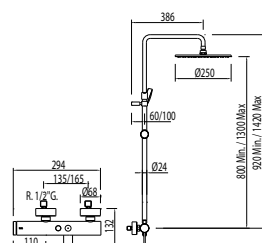

Cr 201.195.01

TRES TOUCH-COOL®

Cr = Cromo/Chrom/Chrome

Termostatiche / Termostatické / Thermostatically-controlled

Ref. / Kód / Nr.:

Doccia LEX-ALPLUS termostatica

(Doccia mobile Ø 100 mm. (5 funzioni) (1.34.748) e flessibile satin (91.34.609.15)).



Termostatická sprchová baterie LEX-ALPLUS

(Masážní ruční sprcha Ø 100 mm (5 proudy) (1.34.748) a hadicí satin (91.34.609.15)).

Wall thermostatic shower mixer LEX-ALPLUS

(Massage hand shower Ø 100 mm. (5 fonctions) (1.34.748) and satin hose (91.34.609.15)).

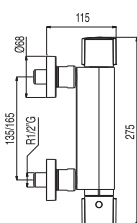

Cr

1.81.164



TRES TOUCH-COOL®



Cr

1.81.164.9

Vasca-Doccia LEX-ALPLUS termostatica

(Doccia mobile Ø 100 mm. (5 funzioni) (1.34.748) e flessibile satin (91.34.609)).



Termostatická vanová a sprchová baterie LEX-ALPLUS

(Masážní ruční sprcha Ø 100 mm (5 proudy) (1.34.748) a hadicí satin (91.34.609)).

Badthermostaat LEX-ALPLUS

(Massage hand shower Ø 100 mm. (5 fonctions) (1.34.748) and satin hose (91.34.609)).

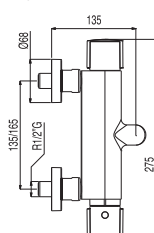

Cr

1.81.174



TRES TOUCH-COOL®



Cr

1.81.174.9

Doccia termostatica

Doccia anticalcare (299.631.03). Flessibile satin (91.34.609.15). **Indicato per persone con disabilità fisiche**



Termostatický vanový

Sprchová koncovka se systémem proti tvorbě vodního kamene (299.631.03), hadice satin (91.34.609.15). Ruční sprcha hadice satin. **Určeno pro osoby s fyzickým handicapem**

Wall thermostatic shower mixer

Shower Antilime (299.631.03). Shower hose satin (91.34.609.15). **Suitable for persons with physical disabilities.**

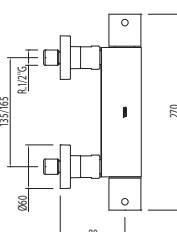

TRES TOUCH-COOL®



Cr

090.964.01

Vasca-Doccia termostatica

Doccia anticalcare (299.631.03). Flessibile satin (91.34.609). **Indicato per persone con disabilità fisiche**



Termostatická vanová a sprchová baterie

Sprchová koncovka se systémem proti tvorbě vodního kamene (299.631.03), hadice satin (91.34.609). Ruční sprcha hadice satin. **Určeno pro osoby s fyzickým handicapem**

Wall thermostatic shower mixer

Shower Antilime (299.631.03). Shower hose satin (91.34.609). **Suitable for persons with physical disabilities.**

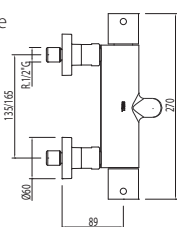

TRES TOUCH-COOL®



Cr

090.974.01

N

Gomito adattore bagno-doccia

Koleno k vanové baterii

Bath and shower adaptable column



con silenziatore
do zdi s gumovými tlumiči
with silencer

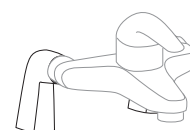
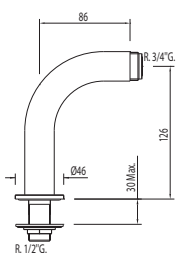

Cr

299.870.01

LEX-TRES

Gruppi termostatici / Termostatické soupravy / Thermostatically-controlled sets

Ref. / Kód / Nr.:



Set doccia LEX termostatica

Doccia fissa Ø 250 mm. (1.34.137.26). Doccia mobile massaggio Ø 100 mm. (5 funzioni) (1.34.748) Flessibile satin (91.34.609.15). Asta telescopica. Invertitore integrato nel regolatore di portata (si veda pagina 576)

Termostatický sprchový set LEX

Hlavová sprcha Ø 250 mm. (1.34.137.26). Masážní ruční sprcha Ø 100 mm (5 proudy) (1.34.748). Hadice satin (91.34.609.15). Tyč s teleskopickou regulací výšky. Přepínač proudů integrovaný s regulátorem tlaku (viz str. 576)

Wall thermostatic shower mixer LEX

Fixed shower head Ø 250 mm. (1.34.137.26). Massage hand shower Ø 100 mm. (5 fonctions) (1.34.748) and satin hose (91.34.609.15). Telescopic bar. Diverter integrated in the flow control (see page 576)

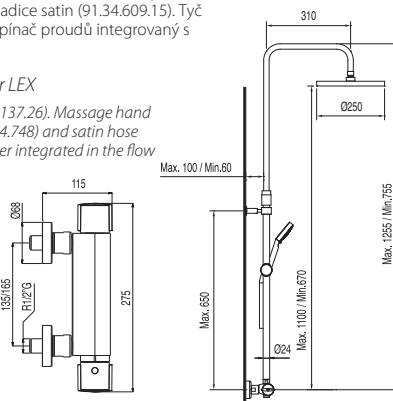

TRES TOUCH-COOL®

Cr 1.90.214



Set doccia LEX termostatica

Doccia fissa Ø 225 mm. (299.632.01). Doccia mobile massaggio Ø 100 mm. (5 funzioni) (1.34.748) e tubo flessibile satin (91.34.609.15). Invertitore integrato nel regolatore di portata (si veda pagina 576)

Termostatický sprchový set LEX

Hlavová sprcha Ø 225 mm. (299.632.01). Masážní ruční sprcha Ø 100 mm (5 proudy) (1.34.748). Hadice satin (91.34.609.15). Přepínač proudů integrovaný s regulátorem tlaku (viz str. 576)

Wall thermostatic shower mixer LEX

Fixed shower head Ø 225 mm. (299.632.01). Massage hand shower Ø 100 mm. (5 fonctions) (1.34.748) and satin hose (91.34.609.15). Diverter integrated in the flow control (see page 576)

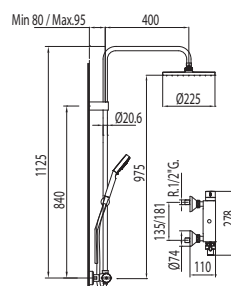

TRES TOUCH-COOL®

Cr 1.81.385



Set doccia LEX termostatica

Doccia fissa da 250x250 mm. (1.34.138.26). Doccia anticalcare (006.639.01). Flessibile satin (91.34.609.15). Asta telescopica. Invertitore integrato nel regolatore di portata (si veda pagina 576)

Termostatický sprchový set LEX

Hlavová sprcha 250x250 mm. (1.34.138.26). Sprchová koncovka se systémem proti tvorbě vodního kamene (006.639.01), hadice satin (91.34.609.15). Tyč s teleskopickou regulací výšky. Přepínač proudů integrovaný s regulátorem tlaku (viz str. 576)

Wall thermostatic shower mixer LEX

Fixed shower head 250x250 mm. (1.34.138.26). Antilime hand shower (006.639.01) and satin hose (91.34.609.15). Telescopic bar. Diverter integrated in the flow control (see page 576)

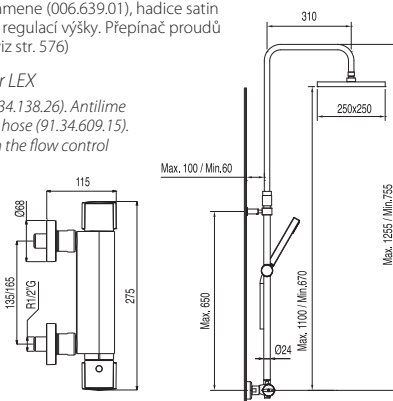

TRES TOUCH-COOL®



OTTONE
MOSAZ
BRASS

Cr 1.90.213

Cr = Cromo/Chrom/Chrome



Set doccia LEX termostatica

Doccia fissa Ø 225 mm. (299.632.01), Doccia mobile massaggio Ø 100 mm. (5 funzioni) (1.34.748) e tubo flessibile satin (91.34.609.15).

Termostatický sprchový set LEX

Hlavová sprcha Ø 225 mm. (299.632.01). Masážní ruční sprcha Ø 100 mm (5 proudy) (1.34.748). Hadice satin (91.34.609.15).

Wall thermostatic shower mixer LEX

Fixed shower head Ø 225 mm. (299.632.01). Massage hand shower Ø 100 mm. (5 functions) (1.34.748) and satin hose (91.34.609.15).

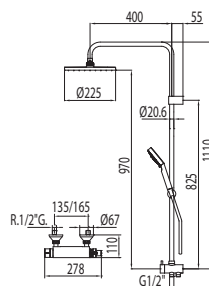

Cr 1.90.385



Kit termostatico vasca ad incasso LEX

Con chiusura e regolazione di portata. (2 vie) Doccia fissa da Ø 250 mm. (1.34.137.26). Supporto per doccia (91.34.182). Doccia mobile massaggio Ø 100 mm. (5 funzioni) (1.34.748) e tubo flessibile satin (91.34.609)

Termostatický podomítkový sprchový set LEX

S uzávěrem a regulací průtoku. (Dvoucestný) Hlavová sprcha Ø 250 mm. (1.34.137.26). Pevný držák s vodní přípojkou pro hadici (91.34.182). Masážní ruční sprcha Ø 100 mm (5 proudy) (1.34.748). Hadice satin (91.34.609).

Concealed thermostatic shower kit LEX

with water shut off and flow control. (2 ways) Fixed shower head Ø 250 mm. (1.34.137.26). Elbow wall (91.34.182). Massage hand shower Ø 100 mm. (5 functions) (1.34.748) and satin hose (91.34.609).

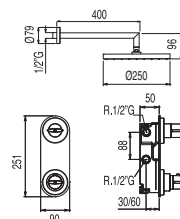

Cr 1.81.175

Elementi per doccia / Sprchové prvky / Shower parts



Asta antiscivolo LEX

Doccia mobile Ø 100 mm. (5 funzioni) (1.34.748) e flessibile satin (91.34.609).

Posuvná tyč LEX

Masážní ruční sprcha Ø 100 mm (5 proudy) (1.34.748) a hadicí satin (91.34.609).

Sliding bar LEX

Massage hand shower Ø 100 mm. (5 functions) (1.34.748) and satin hose (91.34.609).

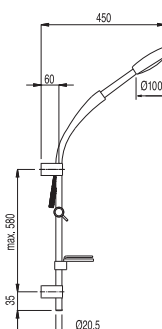

Cr 1.81.921

LEX-TRES

PACK MASTER



Ref.: 081.537.01



Ref.: 081.537.04



RINNOVATE IL VOSTRO BAGNO
RENOVUJTE SVOU KOUPELNU
RENOVATE YOUR BATHROOM

Ricambi / Náhradní díly / Spare parts

	Manopola Úchyt Lever				Tubo flessibile Spojovací hadička pružná Flexible connection	M.10x100x3/8"	
		Cr	91.34.094				91.34.884.02
	Volano Lato portata Pokreťto regulaci strumienia Handle Flow side	(per ref. / Kód / for Nr.: 81.164, 81.174)			Aeratore a scomparsa e chiusura Vnitřní perlátor + klíč Aerator + key	(per ref. / Kód / for Nr.: 81.341)	
		Cr	91.81.081.02				91.34.665
	Volano Lato portata Pokreťto regulaci strumienia Handle Flow side	(per ref. / Kód / for Nr.: 81.385)			Aeratore Perlátor Aerator	(per ref. / Kód / for Nr.: 81.333) M.18x1	
		Cr	91.94.082.28				Cr 92.62.503
	Manopola lato temperatura Kohoutek na straně s regulací teploty Temperature side handle	(per ref. / Kód / for Nr.: 81.164, 81.174)			Scarico automatico Automatický odtok Pop-up waste	1,1/4"	
		Cr	91.81.081.01				Cr 91.34.275.10
	Cartuccia termostatica + volano Termostatická vložka s otočným ovládačem Thermostatic cartridge stem + Handle	(per ref. / Kód / for Nr.: 81.164, 81.174)			Set asta e pulsante Sada přepínače s vedením a úchytem Button and rod set		
		Cr	91.81.161.10				Cr 91.34.275
	Base per lavabo e bidet Ozdobný kroužek pod umyvadlovou baterii Washbasin mixer base				Cartuccia Řídicí vložka Cartridge stem	Ø 35 mm.	
		Cr	91.83.100.01				91.34.591
	Rosone con eccentrico Krycí rozeta s excentrickou spojkou Cover plate + eccentric union				Cartuccia Řídicí vložka Cartridge stem	Ø 35 mm.	
		Cr	91.81.170.09				91.34.592
	Invertitore automatico Automatický přepínač Diverter				Montaggio Hlava Cartridge	(per ref. / Kód / for Nr.: 81.164)	
		Cr	91.34.260				91.34.282



ALPLUS

203.103.01

ALPLUS

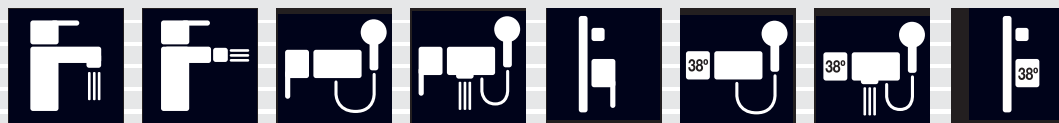



ALPLUS

203.103.03

ALPLUS

Lavabi / Umyvadla / Basins

Ref. / Kód / Nr.:

N



Monocomando lavabo
Umyvadlová baterie
Single lever washbasin mixer

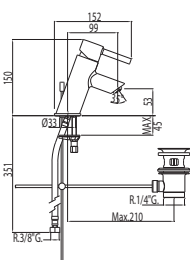

91.34.592

Cr

203.103.01



91.34.592

Cr

203.103.01.D

N



Monocomando lavabo
Umyvadlová baterie
Single lever washbasin mixer

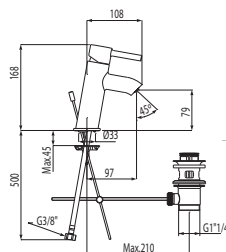

91.34.592

Cr

203.903.01



91.34.592

Cr

203.903.01.D

N



Monocomando lavabo
Umyvadlová baterie
Single lever washbasin mixer

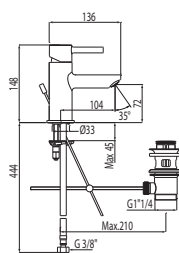

91.34.592

Cr

203.103.03



91.34.592

Cr

203.103.03.D

Cr = Cromo/Chrom/Chrome

 Raccomandabile installare la valvola SIMPLE RAPID (non inclusa)
Doporučuje se použít ventil Simple Rapid (není v ceně)
Ideal assembly with SIMPLE RAPID valve (This is not included)

MISURE SPECIALI / NESTANDARDNÍ ROZMERY / EXCEPTIONAL MEASURES

N

Monocomando lavabo
con prolunga inferiore

Umyvadlová baterie
S prodlužkou

Single lever washbasin mixer
with base extension

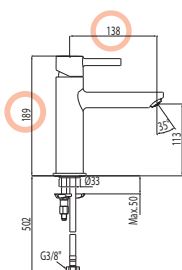
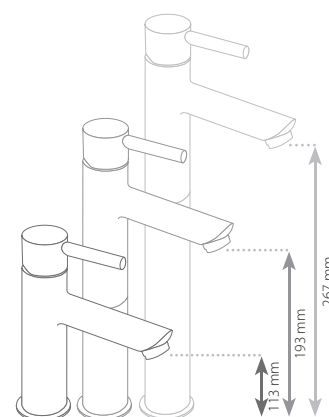
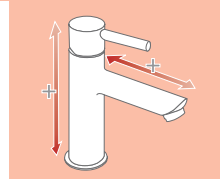

00.00.000

Cr

203.203.01

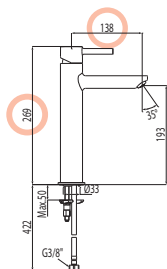

00.00.000

Cr

203.203.01.D



00.00.000

Cr

203.217.01



00.00.000

Cr

203.217.01.D

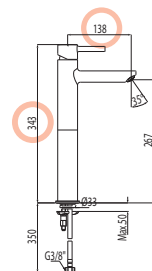

00.00.000

Cr

203.207.01



00.00.000

Cr

203.207.01.D

Cr = Cromo/Chrom/Chrome

 Raccomandabile installare la valvola SIMPLE RAPID (non inclusa)
Doporučuje se použít ventil Simple Rapid (není v ceně)
Ideal assembly with SIMPLE RAPID valve (This is not included)

N

Monocomando lavabo
 Umyvadlová baterie
 Single lever washbasin mixer

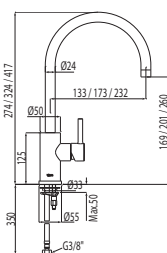
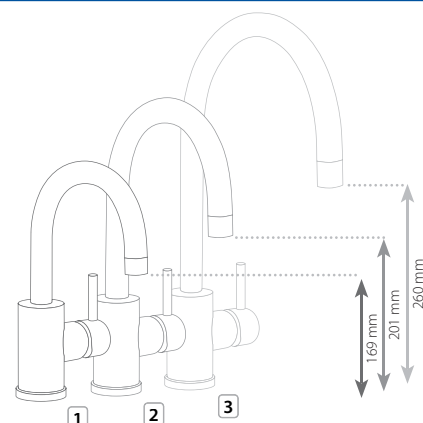

1			Cr	203.703.01
2			Cr	203.403.01
3			Cr	203.303.01



Gruppo lavabo
 Temporizzata 6,5 l/m.
 Pneumatický umyvadlový kohoutek
 Časový 6,5 l/m.
 Tap from framemounted washbasin
 Temporize 6,5 ltr./m.

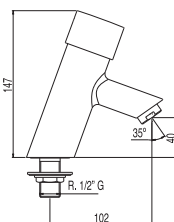

Cr	1.12.203
----	----------



Rubinetto lavabo 1 acqua
 Umyvadlová baterie pro studenou nebo
 smíšenou vodu
 Basin pillar tap only cold water

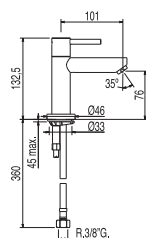

91.34.272.20	Cr	1.62.503
--------------	----	----------



Monocomando lavabo Ø 30 mm.
 Umyvadlová baterie Ø 30 mm.
 Single lever washbasin mixer Ø 30 mm.

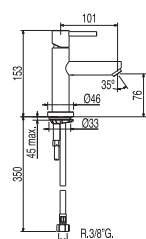









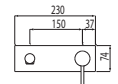

91.62.190	Cr	1.62.603
-----------	----	----------

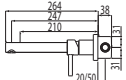
Cr = Cromo/Chrom/Chrome

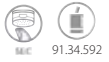

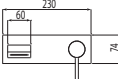
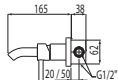

Raccomandabile installare la valvola SIMPLE RAPID (non inclusa)
 Doporučuje se použít ventil Simple Rapid (není v ceně)
 Ideal assembly with SIMPLE RAPID valve (This is not included)





ALPLUS

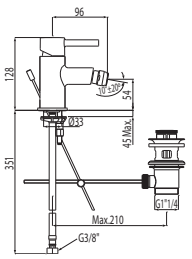
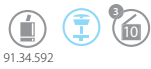

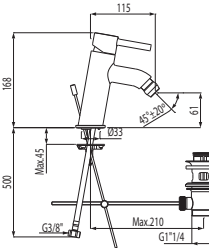

		Ref. / Kód / Nr.:	
 	Monomando a muro Nastěnná směšovací baterie <i>Single lever wall washbasin mixer</i>		 (16 cm.) 91.34.592 Cr 203.210.01
			 (21 cm.) 91.34.592 Cr 203.200.02
			 (25 cm.) 91.34.592 Cr 203.200.01

 	Monomando a muro con bocca a cascata Nastěnná směšovací baterie s přívalem přítokem <i>Single lever wall washbasin mixer with cascade cast spout</i>		
			 91.34.592 Cr 203.260.01

Bidet / Bidety / Bidets

		Ref. / Kód / Nr.:	
 	Monocomando bidet Bidetová baterie <i>Single lever bidet mixer</i>		 91.34.592 Cr 203.120.03
			 91.34.592 Cr 203.120.03.D

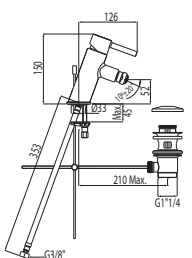
 	Monocomando bidet Bidetová baterie <i>Single lever bidet mixer</i>		 91.34.592 Cr 203.920.01
			 91.34.592 Cr 203.920.01.D

 	Monocomando bidet Bidetová baterie <i>Single lever bidet mixer</i>		 91.34.592 Cr 203.120.01
			 91.34.592 Cr 203.120.01.D

Cr = Cromo/Chrom/Chrome

 Raccomandabile installare la valvola SIMPLE RAPID (non inclusa)
 Doporučuje se použít ventil Simple Rapid (není v ceně)
 Ideal assembly with SIMPLE RAPID valve (This is not included)

Ref. / Kód / Nr.:



Monocomando bidet
Bidetová baterie
Single lever bidet mixer

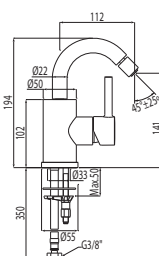

91.34.592

Cr	203.224.01
----	------------



Monocomando bidet con doccia
Jednopáková baterie se sprškou pro bidet
Bidet mixer tap with small shower head

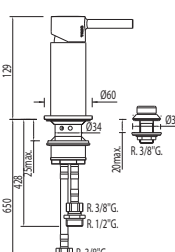

Cr	203.130.01
----	------------



Monocomando ad incasso per bidé WC ALPLUS
Supporto a destra o a sinistra, intercambiabile.
Flesso satinato
Záchodová baterie se směšovačem teplot ALPLUS
Pravý nebo levý podstavec, vyměnitelný.
Hadice satin
Concealed single lever bidet/toilets ALPLUS
Left or right support, interchangeable.
Sateen hose

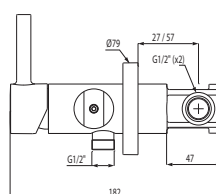

OTTONE
MOSAZ
BRASS



91.34.591

Cr	203.223.01
Cr	203.222.01*



Monocomando ad incasso per bidé WC ALPLUS
Canna girevole e flesso satinato
Záchodová baterie se směšovačem teplot ALPLUS
Nástavec ruční sprchy s tlačítkem uzavírajícím vodní proud a hadice satin
Concealed single lever bidet/toilets ALPLUS
Rotating spout sateen hose

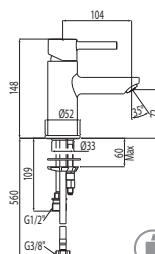

Brevettato®
Patentovaný®
Patented®

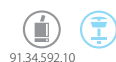

91.34.592.10

Cr	203.113.01
----	------------



Monocomando ad incasso per bidé WC ALPLUS
Flesso satinato
Záchodová baterie se směšovačem teplot ALPLUS
Hadice satin
Concealed single lever bidet/toilets ALPLUS
Sateen hose

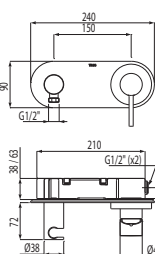

OTTONE
MOSAZ
BRASS



91.34.591

Cr	203.123.01
Cr	203.122.01*

* Opzione Cartongesso
Možnost pro sádrokartonové panely
Optie gips

ALPLUS

Monocomandi bagno / Jednopákový mechanizmus vany / Bathtub mixer taps

Ref. / Kód / Nr.:

N



Monocomando doccia

Doccia anticalcare (299.631.03).
Flessibile satin (91.34.609.15).

Sprchová baterie

Ruční sprchy se systémem proti vzniku vodního kamene (299.631.03), hadice satin (91.34.609.15).

Single lever shower mixer

Antilime hand shower (299.631.03)
and satin hose (91.34.609.15).

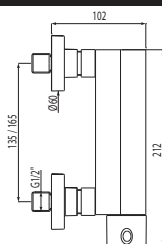

Cr

203.167.01

N



Monocomando vasca

Doccia anticalcare (299.631.03).
Flessibile satin (91.34.609.15).

Vanová baterie

Ruční sprchy se systémem proti vzniku vodního kamene (299.631.03), hadice satin (91.34.609.15).

Single lever bath and shower mixer

Antilime hand shower (299.631.03)
and satin hose (91.34.609.15).

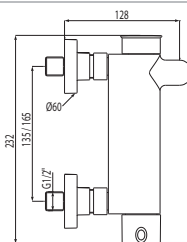

Cr

203.170.01

N



Set doccia ALPLUS

Doccia fissa Ø 225 mm. (299.632.01). Doccia anticalcare (299.631.03).
Flessibile satin (91.34.609.15).

Podomítkový set se sprchou ALPLUS

Hlavová sprcha Ø 225 mm. (299.632.01). Ruční sprchy se systémem proti vzniku vodního kamene (299.631.03), hadice satin (91.34.609.15).

Bar-shower ALPLUS set

Fixed shower head Ø 225 mm. (299.632.01). Antilime hand shower (299.631.03)
and satin hose (91.34.609.15).

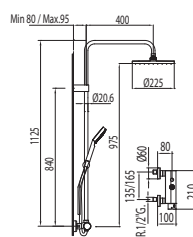

Cr

203.191.01

Bordovasca / Vany s prodlouženým pultem / Deck-mounted bathtubs

Ref. / Kód / Nr.:

N

Monocomando bordo vasca Doccia anticalcarea (299.631.03).

Vanová 3-otvorová stojánková baterie s progresivním regulátorem
Ruční sprchy se systémem proti vzniku vodního kamene (299.631.03).

*Bath-shower single lever tap for bracket shelf
Antilime hand shower (299.631.03).*

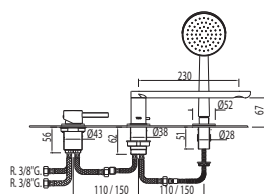

°C
3 bar
16 l/m



91.34.591

Cr

203.161.01

N

Kit bordo vasca Facile montaggio superiore. Senza registro

Montážní sada k 3-otvorové baterii s odtokem zbytků vody
Snadná montáž/demontáž seshora. Není nutné montovat dodatečné revizní prvky u vany

*Bath-shower kit cistern
easy upper assembly, without installation*

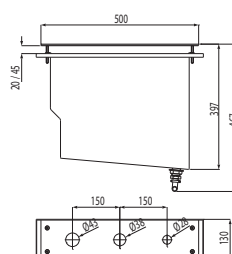

Brevettato®
Patentovaný®
Patented®

Cr

203.245.01



Valvola vasca con presa drenaggio

Vanový sifon typu click-clack s přípojkou k odtokovému systému 3-otvorové baterie

Bath valve with drainage point

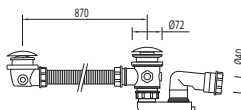

Cr

1.34.445

Ad incasso / Vestavěné / Built-in

Ref. / Kód / Nr.:

N

Monocomando ad incasso doccia

Podomítková sprchová baterie
Single lever concealed shower mixer

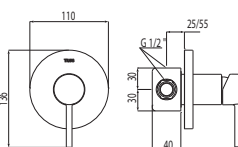

91.34.592

Cr

203.177.01

N

Monocomando incasso bagno doccia

Podomítková vanová baterie s ruční sprchou

Single lever concealed bath and shower mixer

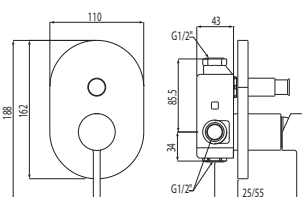

91.34.592

Cr

203.180.01

Cr = Cromo/Chrom/Chrome

ALPLUS

Gruppi ad incasso / Vestavěné soupravy / Built-in sets

Ref. / Kód / Nr.:



N

Kit doccia ad incasso ALPLUS

Doccia fissa da Ø 225 mm. (299.632.01).

Podomítkový set se sprchou ALPLUS
Hlavová sprcha Ø 225 mm. (299.632.01).

Concealed shower set ALPLUS

Fixed shower head Ø 225 mm. (299.632.01).

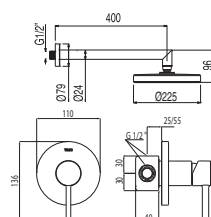

91.34.592

Cr

203.177.02



N

Kit doccia ad incasso ALPLUS

Doccia fissa da Ø 225 mm. (299.632.01). Supporto per doccia (91.34.182).
Doccia anticalcare (299.631.03). Flessibile satin (91.34.609.15).

Podomítkový set se sprchou ALPLUS

Hlavová sprcha Ø 225 mm. (299.632.01). Pevný držák s vodní přípojkou pro hadici (91.34.182). Ruční sprchy se systémem proti vzniku vodního kamene (299.631.03), hadice satin (91.34.609.15).

Concealed shower set ALPLUS

Fixed shower head Ø 225 mm. (299.632.01). Elbow wall (91.34.182). Antilime hand shower (299.631.03) and satin hose (91.34.609.15).

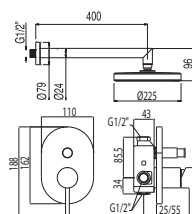

91.34.592

Cr

203.180.02



N

Kit doccia ad incasso ALPLUS

Doccia fissa da Ø 225 mm. (299.632.01). Asta antiscivolo lunga 550 mm. (1.34.618).
Presa a parete (1.34.758). Doccia anticalcare (299.631.03). Flessibile satin (91.34.609.15).

Podomítkový sprchový set ALPLUS

Hlavová sprcha Ø 225 mm. (299.632.01). Posuvná tyč. Délka 550 mm. (1.34.618).
Pevný držák s vodní přípojkou pro hadici (1.34.758). Pevný držák s vodní přípojkou pro hadici (1.34.758). Ruční sprchy se systémem proti vzniku vodního kamene (299.631.03), hadice satin (91.34.609.15).

Concealed shower kit ALPLUS

Fixed shower head Ø 225 mm. (299.632.01). Bar-shower antilime. long. 550 mm. (1.34.618). Elbow wall (1.34.758). Antilime hand shower (299.631.03) and satin hose (91.34.609.15).

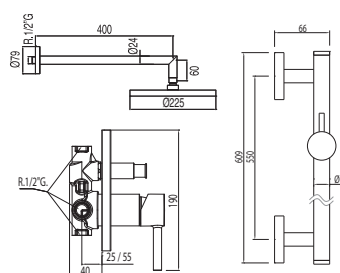

91.34.592

Cr

203.180.03

Cr = Cromo/Chrom/Chrome

MONO-TERM® Monocomandi bagno / Jednopákový mechanismus vany / Bathtub mixer taps

Ref. / Kód / Nr.:

MONO-TERM® doccia

Doccia mobile Ø 100 mm. (5 funzioni) (1.34.748) e flessibile satin (91.34.609.15).

MONO-TERM® Sprchová baterie

Masážní ruční sprcha Ø 100 mm (5 proudy) (1.34.748) a hadicí satin (91.34.609.15).

MONO-TERM® Single lever shower mixer

Massage hand shower Ø 100 mm. (5 fonctions) (1.34.748) and satin hose (91.34.609.15).

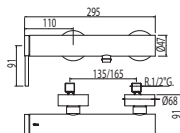
TRES TOUCH-COOL®

Cr

201.167.01

MONO-TERM® vasca

Doccia mobile Ø 100 mm. (5 funzioni) (1.34.748) e flessibile satin (91.34.609).

MONO-TERM® Vanová baterie

Masážní ruční sprcha Ø 100 mm (5 proudy) (1.34.748) a hadicí satin (91.34.609).

MONO-TERM® Single lever bath and shower mixer

Massage hand shower Ø 100 mm. (5 fonctions) (1.34.748) and satin hose (91.34.609).

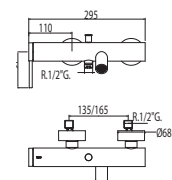
TRES TOUCH-COOL®

Cr

201.170.01

MONO-TERM® Ad incasso / Vestavěné / Built-in

Ref. / Kód / Nr.:

MONO-TERM® da incasso doccia

Con chiusura e regolazione di portata

MONO-TERM® k vestavění pro sprchu

S uzávěrem a regulací průtoku

Built-in MONO-TERM® for showers

With water shut off and flow control

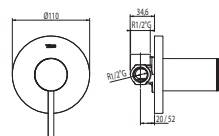

Cr

201.177.02

MONO-TERM® da incasso bagno-doccia

Con chiusura e regolazione di portata

MONO-TERM® k vestavění pro vanu-sprchu

S uzávěrem a regulací průtoku

Built-in MONO-TERM® for bathtubs-showers

With water shut off and flow control

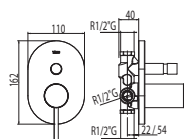

Cr

201.180.02

MONO-TERM® Kit / Set / Set

Ref. / Kód / Nr.:



Kit MONO-TERM® da incasso doccia

Con chiusura e regolazione di portata. Doccia fissa Ø 225 mm. (299.632.01). Doccia mobile Ø 100 mm. (5 funzioni) (1.34.748) e flessibile satin (91.34.609.15). Con presa a parete

MONO-TERM® k vestavění pro sprchu

S uzavěrem a regulací průtoku. Hlavová sprcha Ø 225 mm. (299.632.01). Regulovaná sprcha Ø 100 mm. (5 proudy) (1.34.748). Hadice satin (91.34.609.15). Sprcha se spodní přípojkou vody.

Built-in MONO-TERM® for showers

With water shut off and flow control. Fixed shower head Ø 225 mm. (299.632.01). Hand shower Ø 100 mm. (5 functions) (1.34.748) and satin hose (91.34.609.15). With wall entrance

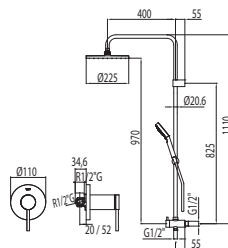

Cr 201.177.03



Kit MONO-TERM® da incasso doccia

Con chiusura e regolazione di portata. Doccia fissa da Ø 250 mm. (1.34.137.26). Supporto per doccia (91.34.182). Doccia mobile Ø 100 mm. (5 funzioni) (1.34.748) e flessibile satin (91.34.609.15).

MONO-TERM® k vestavění pro sprchu

S uzavěrem a regulací průtoku. Hlavová sprcha Ø 250 mm. (1.34.137.26). Pevný držák s vodní přípojkou pro hadici (91.34.182). Regulovaná sprcha Ø 100 mm. (5 proudy) (1.34.748). Hadice satin (91.34.609.15).

Built-in MONO-TERM® for showers

With water shut off and flow control. Fixed shower head Ø 250 mm. (1.34.137.26). Elbow wall (91.34.182). Massage hand shower Ø 100 mm. (5 functions) (1.34.748) and satin hose (91.34.609.15).

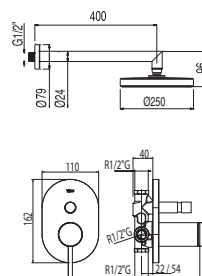

Cr 201.180.03



Kit MONO-TERM®

Doccia fissa Ø 250 mm. (1.34.137.26). Doccia mobile massaggio Ø 100 mm. (5 funzioni) (1.34.748) Flessibile satin (91.34.609.15). Asta telescopica.

Sprchový set MONO-TERM®

Hlavová sprcha Ø 250 mm. (1.34.137.26). Masážní ruční sprcha Ø 100 mm (5 proudy) (1.34.748). Hadice satin (91.34.609.15). Tyč s teleskopickou regulací výšky.

Bar-shower MONO-TERM® set

Fixed shower head Ø 250 mm. (1.34.137.26). Massage hand shower Ø 100 mm. (5 functions) (1.34.748) and satin hose (91.34.609.15). Telescopic bar.

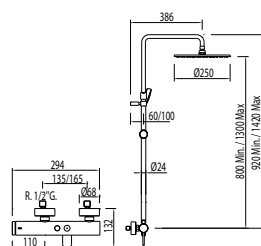

Cr 201.195.01

TRES TOUCH-COOL

Cr = Cromo/Chrom/Chrome

Termostatiche / Termostatické / Thermostatically-controlled Ref. / Kód / Nr.:

	<p>Doccia ALPLUS-LEX termostatica (Doccia anticalcare (299.631.03). Flessibile satin (91.34.609.15)).</p> <p>Termostatická sprchová baterie ALPLUS-LEX (Ruční sprchy se systémem proti vzniku vodního kamene (299.631.03), hadice satin (91.34.609.15)).</p> <p><i>Wall thermostatic shower mixer ALPLUS-LEX</i> (Antilime hand shower (299.631.03) and satin hose (91.34.609.15)).</p>			<p>Cr 1.81.164</p>
	<p>ECO TRES TOUCH-COOL®</p>			<p>Cr 203.164.09</p>
	<p>Vasca-Doccia ALPLUS-LEX termostatica (Doccia anticalcare (299.631.03). Flessibile satin (91.34.609)).</p> <p>Termostatická vanová a sprchová baterie ALPLUS-LEX (Ruční sprchy se systémem proti vzniku vodního kamene (299.631.03), hadice satin (91.34.609)).</p> <p><i>Badthermostaat ALPLUS-LEX</i> (Antilime hand shower (299.631.03) and satin hose (91.34.609)).</p>			<p>Cr 1.81.174</p>
	<p>ECO TRES TOUCH-COOL®</p>			<p>Cr 203.174.09</p>
	<p>Doccia termostatica Doccia anticalcare (299.631.03). Flessibile satin (91.34.609.15). Indicato per persone con disabilità fisiche</p> <p>Termostatický vanový Sprchová koncovka se systémem proti tvorbě vodního kamene (299.631.03), hadice satin (91.34.609.15). Ruční sprcha hadice satin. Určeno pro osoby s fyzickým handicapem</p> <p><i>Wall thermostatic shower mixer Shower Antilime (299.631.03). Shower hose satin (91.34.609.15). Suitable for persons with physical disabilities.</i></p>			<p>Cr 090.964.01</p>
	<p>ECO TRES TOUCH-COOL®</p>			<p>Cr 090.964.01</p>
	<p>Vasca-Doccia termostatica Doccia anticalcare (299.631.03). Flessibile satin (91.34.609). Indicato per persone con disabilità fisiche</p> <p>Termostatická vanová a sprchová baterie Sprchová koncovka se systémem proti tvorbě vodního kamene (299.631.03), hadice satin (91.34.609). Ruční sprcha hadice satin. Určeno pro osoby s fyzickým handicapem</p> <p><i>Wall thermostatic shower mixer Shower Antilime (299.631.03). Shower hose satin (91.34.609). Suitable for persons with physical disabilities.</i></p>			<p>Cr 090.974.01</p>
	<p>ECO TRES TOUCH-COOL®</p>			<p>Cr 090.974.01</p>
	<p>2 prese da terra per vasca con supporto girevole</p> <p>2 podlahové přípojky k vanové baterii s otočnou úchytkou</p> <p><i>2-outlet bathtub base With revolving stand</i></p>	<p>Cr 1.61.194</p>		

ALPLUS

Gruppi termostatici / Termostatické soupravy / Thermostatically-controlled sets

Ref. / Kód / Nr.:



Set doccia ALPLUS termostatica

Doccia fissa Ø 250 mm. (1.34.137.26). Doccia anticalcare (299.631.03). Flessibile satin (91.34.609.15). Asta telescopica. Invertitore integrato nel regolatore di portata (si veda pagina 576)

Termostatický sprchový set ALPLUS

Hlavová sprcha Ø 250 mm. (1.34.137.26). Ruční sprchy se systémem proti vzniku vodního kamene (299.631.03), hadice satin (91.34.609.15). Tyč s teleskopickou regulací výšky. Přepínač proudů integrovaný s regulátorem tlaku (viz str. 576)

Wall thermostatic shower mixer ALPLUS

Fixed shower head Ø 250 mm. (1.34.137.26). Antilime hand shower (299.631.03) and satin hose (91.34.609.15). Telescopic bar. Diverter integrated in the flow control (see page 576)

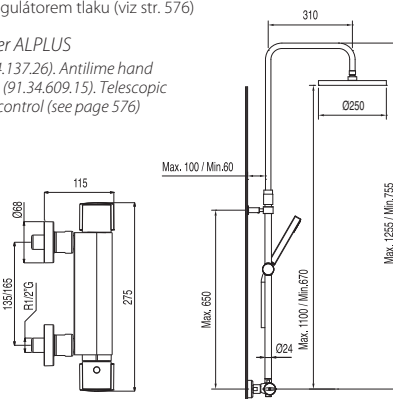

TRES TOUCH-COOL

Cr 203.385.03



Set doccia ALPLUS termostatica

Doccia fissa Ø 225 mm. (299.632.01). Doccia anticalcare (299.631.03). Flessibile satin (91.34.609.15). Invertitore integrato nel regolatore di portata (si veda pagina 576)

Termostatický sprchový set ALPLUS

Hlavová sprcha Ø 225 mm. (299.632.01). Ruční sprchy se systémem proti vzniku vodního kamene (299.631.03), hadice satin (91.34.609.15). Přepínač proudů integrovaný s regulátorem tlaku (viz str. 576)

Wall thermostatic shower mixer ALPLUS

Fixed shower head Ø 225 mm. (299.632.01). Antilime hand shower (299.631.03) and satin hose (91.34.609.15). Diverter integrated in the flow control (see page. 576)

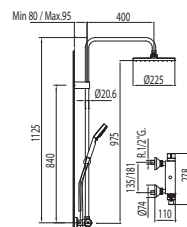

TRES TOUCH-COOL

Cr 203.385.01



Set doccia ALPLUS termostatica

Doccia fissa Ø 225 mm. (299.632.01). Doccia anticalcare (299.631.03). Flessibile satin (91.34.609.15).

Termostatický sprchový set ALPLUS

Hlavová sprcha Ø 225 mm. (299.632.01). Ruční sprchy se systémem proti vzniku vodního kamene (299.631.03), hadice satin (91.34.609.15).

Wall thermostatic shower mixer ALPLUS

Fixed shower head Ø 225 mm. (299.632.01). Antilime hand shower (299.631.03) and satin hose (91.34.609.15).

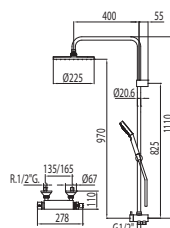

Cr 203.385.02

Cr = Cromo/Chrom/Chrome



Kit termostatico vasca ad incasso ALPLUS

Con chiusura e regolazione di portata. (2 vie) Doccia fissa da Ø 250 mm. (1.34.137.26).
Supporto per doccia (91.34.182). Doccia anticalcare (299.631.03). Flessibile satin (91.34.609.15).

Termostatický podomítkový sprchový set ALPLUS

S uzávěrem a regulací průtoku. (Dvoucestný) Hlavová sprcha Ø 250 mm. (1.34.137.26).
Pevný držák s vodní přípojkou pro hadici (91.34.182). Ruční sprchy se systémem proti vzniku vodního kamene (299.631.03), hadice satin (91.34.609.15).

Concealed thermostatic shower kit ALPLUS

with water shut off and flow control. (2 ways) Fixed shower head Ø 250 mm. (1.34.137.26).
Elbow wall (91.34.182). Antilime hand shower (299.631.03) and satin hose (91.34.609.15).

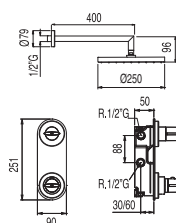

Cr

203.175.01

ALPLUS

PACK MASTER



N Ref.: 203.537.07



N Ref.: 203.537.04



N Ref.: 203.537.01



RINNOVATE IL VOSTRO BAGNO
RENOVUJTE SVOU KOUPELNU
RENOVATE YOUR BATHROOM

Ricambi / Náhradní díly / Spare parts

	Manopola Úchyt <i>Lever</i>	Cr 91.34.095		Invertitore automatico (per ref. / Kód / for Nr.: 203.170.01) Automatický přepínač <i>Diverter</i>	Cr 91.34.260
	Manopola Úchyt <i>Lever</i> (per ref. / Kód / for Nr.: 203.167.01, 203.170.01)	Cr 91.34.095.20		Aeratore (per ref. / Kód / for Nr.: 62.503, 62.603) Perlátor <i>Aerator</i> M.18x1	Cr 92.62.503
	Volano Lato portata Pokreťto regulacji strumienia <i>Handle Flow side</i> (per ref. / Kód / for Nr.: 81.164, 81.174, 203.164, 203.174)	Cr 91.81.081.02		Scarico automatico Automatický odtok <i>Pup-up waste</i> 1,1/4"	Cr 91.34.275.10
	Manopola lato temperatura Kohoutek na straně s regulací teploty <i>Temperature side handle</i> (per ref. / Kód / for Nr.: 81.164, 81.174, 203.164, 203.174)	Cr 91.81.081.01		Set asta e pulsante Sada přepínače s vedením a úchytem <i>Button and rod set</i>	Cr 91.34.275
	Base per lavabo e bidet Kroužek pod umyvadlové a bidetové baterie <i>Mixer base</i>	Cr 91.83.100.01		Montaggio ceramica (per ref. / Kód / for Nr.: 62.503) Hlava keramika <i>Cartridge ceramic</i>	Cr 91.34.272.20
	Rosone con eccentrico Krycí rozeta s excentrickou spojkou <i>Cover plate + eccentric union</i>	Cr 91.81.170.09			

□ MONOCLASIC1900



1.47.103.02



1.42.194.02



1.42.167.02

MONOCLASIC 1900



MONOCLASIC 1900

Lavabi / Umyvadla / Basins

Ref. / Kód / Nr.:



Monocomando lavabo
 Umyvadlová baterie
 Single lever washbasin mixer



91.34.290

Cr	1.42.103.02
Lv	5.42.103.02.01
Ac	5.42.103.02.03



Monocomando bidet
 Bidetová baterie
 Single lever bidet mixer



91.34.290

Cr	1.42.120.02
Lv	5.42.120.02.01
Ac	5.42.120.02.03



Monocomando bidet
 Bidetová baterie
 Single lever bidet mixer



91.34.290

Cr	1.47.120.02
Lv	5.47.120.02.01
Ac	5.47.120.02.03

Bidet / Bidety / Bidets

Ref. / Kód / Nr.:

Cr = Cromo/Chrom/Chrome Lv = Ottone antico/stará mosaz/Old brass Ac = Acciaio/Kartáčovaná ocel/Steel

 Raccomandabile installare la valvola SIMPLE RAPID (non inclusa)
 Doporučuje se použít ventil Simple Rapid (není v ceně)
 Ideal assembly with SIMPLE RAPID valve (This is not included)

Monocomandi bagno / Jednoplákový mechanismus vany / Bathtub mixer taps

Ref. / Kód / Nr.:

Monocomando doccia
 Doccia anticalcare. Flessibile
 doppia graffatura

 Sprchová baterie
 Sprchová koncovka se systémem
 proti tvorbě vodního kamene,
 hadice s dvojitým opletem

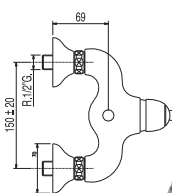
Single lever shower mixer
Shower Antilime. Double interlocked
shower hose

Cr	1.42.167.02
Lv	5.42.167.02.01
Ac	5.42.167.02.03

Monocomando vasca
 Doccia anticalcare. Flessibile
 doppia graffatura

 Vanová baterie
 Sprchová koncovka se systémem
 proti tvorbě vodního kamene,
 hadice s dvojitým opletem

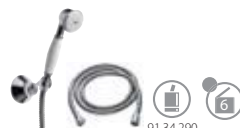
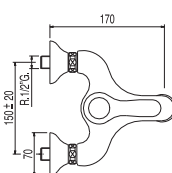
Single lever bath and shower mixer
Shower Antilime. Double interlocked
shower hose

Cr	1.42.170.02
Lv	5.42.170.02.01
Ac	5.42.170.02.03

Ad incassio / Vestavěné / Built-in

Ref. / Kód / Nr.:

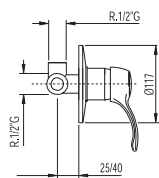

Monocomando ad incasso doccia

 Podomítková sprchová baterie
Single lever concealed shower mixer

Cr	042.177.12
----	------------

Monocomando incasso bagno doccia con deviatore

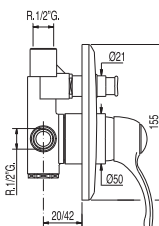
 Podomítková vanová baterie s
 ruční sprchou

Single lever concealed bath and
shower mixer

Cr	042.180.12
----	------------

Cr = Cromo/Chrom/Chrome Lv = Ottone antico/stará mosaz/Old brass Ac = Acciaio/Kartáčovaná ocel/Steel

MONOCLASIC 1900

Bordovasca / Vany s prodlouženým pultem / Deck-mounted bathtubs

Ref. / Kód / Nr.:

Monocomando bordo vasca

Vanová 3-otvorová stojánková baterie

Bath-shower single lever tap for bracket shelf

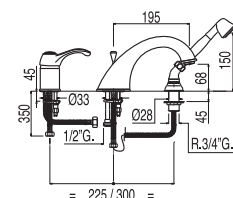

Cr	1.42.145.02
Lv	5.42.145.02.01
Ac	5.42.145.02.03



Kit bordo vasca

Facile montaggio superiore. Senza registro

Montážní sada k 3-otvorové baterii s odtokem zbytků vody
Snadná montáž/demontáž shora.
Není nutné montovat dodatečně revizní prvky u vany

*Bath-shower kit cistern
easy upper assembly, without installation*

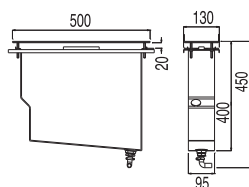

Brevettato®
Patentovaný®
Patented®

Cr	1.34.245
----	----------



Valvola vasca con presa drenaggio

Vanový sifon typu click-clack s přípojkou k odtokovému systému 3-otvorové baterie

Bath valve with drainage point

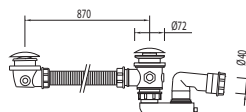

Cr	1.34.445
----	----------



Gruppo vasca con presa a pavimento Doccia anticalcareo. Flessibile doppia graffatura

Vanová baterie s podlahovými přípojkami
Sprchová koncovka se systémem proti tvorbě vodního kamene, hadice s dvojitým opletem

*Bath & shower mixer with connections to the floor
Shower Antilime. Double interlocked shower hose*

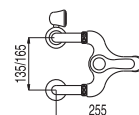
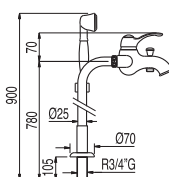

Cr	1.42.194.02
Lv	042.194.02.LV

Monocomando bordo vasca

Doccia anticalcareo. Flessibile doppia graffatura

Vanová 3-otvorová stojánková baterie
Sprchová koncovka se systémem proti tvorbě vodního kamene, hadice s dvojitým opletem

*Bath-shower single lever tap for bracket shelf
Shower Antilime. Double interlocked shower hose*

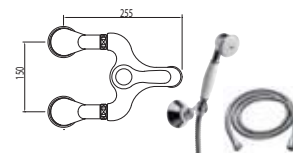
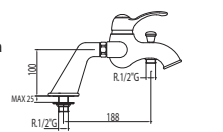

Cr	042.194.01
Lv	042.194.01.LV

Cr = Cromo/Chrom/Chrome

Ref. / Kód / Nr.:



Gomito adattabile vasca

Koleno k vanové baterii
Adaptable elbow

con silenziatore
do zdi s gumovými tlumiči
with silencer

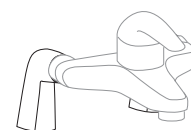
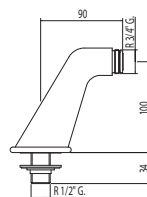

Cr 024.871.01
Lv 024.871.01.LV



2 prese da terra da vasca MONOCLASIC

2 podlahové přípojky k vanovým
bateriím MONOCLASIC
*2-outlet bathtub base
MONOCLASIC*

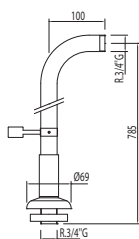

Cr 1.24.194
Lv 024.194.01.LV

Termostatiche / Termostatické / Thermostatically-controlled

Ref. / Kód / Nr.:



Doccia MONOCLASIC termostatica

Flessibile doppia graffatura e
flesso satinato.

Termostatický vanový
MONOCLASIC
Sprchová hadice s dvojitým
opletem

*Wall thermostatic shower mixer
MONOCLASIC
double interlocked shower hose*

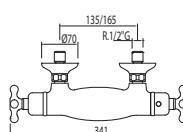

Cr 032.164.09
Lv 032.164.09.LV



Bagno doccia MONOCLASIC termostatica

Flessibile doppia graffatura e
flesso satinato.

Termostatická vanová baterie
MONOCLASIC
Sprchová hadice s dvojitým
opletem

*Wall thermostatic bath and
shower mixer MONOCLASIC
double interlocked shower hose*

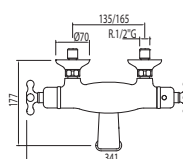

Cr 032.174.09
Lv 032.174.09.LV



Bagno doccia MONOCLASIC termostatica

Flessibile doppia graffatura e
flesso satinato.

Termostatická vanová baterie
MONOCLASIC
Sprchová hadice s dvojitým
opletem

*Wall thermostatic bath and
shower mixer MONOCLASIC
double interlocked shower hose*

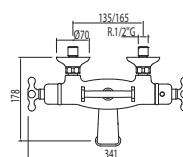

Cr 032.176.09
Lv 032.176.09.LV

MONOCLASIC 1900

Gruppi termostatici / Termostatické soupravy / Thermostatically-controlled sets

Ref. / Kód / Nr.:



Set doccia MONOCLASIC termostatica

Con chiusura e regolazione di portata. Doccia fissa da Ø 260 mm. Doccia anticalcarea (91.34.824). Flessibile doppia graffatura (91.34.828).

Termostatický sprchový set MONOCLASIC

S uzávěrem a regulací průtoku. Hlavová sprcha Ø 260 mm. Sprchová koncovka se systémem proti tvorbě vodního kamene (91.34.824). Hadice s dvojitým opletem (91.34.828).

Wall thermostatic shower mixer MONOCLASIC

with water shut off and flow control. Fixed shower head Ø 260 mm. Shower Antilime (91.34.824). Double interlocked shower hose (91.34.828).

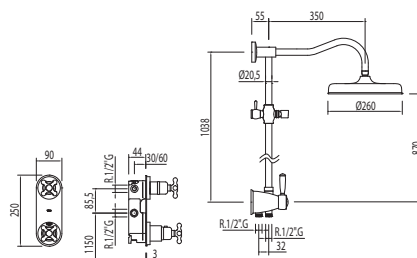

Cr 042.970.01



Kit doccia termostatica MONOCLASIC

Con chiusura e regolazione di portata. (2 vie) Doccia fissa da Ø 260 mm. Supporto per doccia (024.182.01). Doccia anticalcarea (91.34.824). Flessibile doppia graffatura (91.34.828).

Termostatický sprchový set MONOCLASIC

S uzávěrem a regulací průtoku. (Dvoucestný) Hlavová sprcha Ø 260 mm. Pevný držák s vodní přípojkou pro hadici (024.182.01). Ruční sprchy se systémem proti vzniku vodního kamene (91.34.824). Hadice s dvojitým opletem (91.34.828).

Thermostatic bar-shower MONOCLASIC

with water shut off and flow control. (2 ways) Fixed shower head Ø 260 mm. Elbow wall (024.182.01). Antilime hand shower (91.34.824). Double interlocked shower hose (91.34.828).

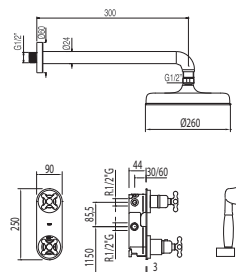

Cr 042.970.02



Set doccia MONOCLASIC termostatica

Doccia fissa da Ø 260 mm. Doccia anticalcarea (91.34.824). Flessibile doppia graffatura (91.34.828).

Termostatický sprchový set MONOCLASIC

Hlavová sprcha Ø 260 mm. Sprchová koncovka se systémem proti tvorbě vodního kamene (91.34.824). Hadice s dvojitým opletem (91.34.828).

Wall thermostatic shower mixer MONOCLASIC

Fixed shower head Ø 260 mm. Shower Antilime (91.34.824). Double interlocked shower hose (91.34.828).

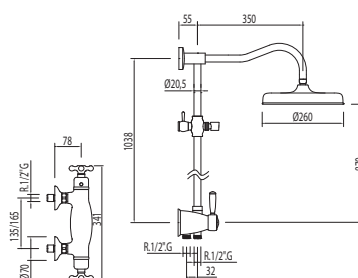

Cr 032.195.01

Cr = Cromo/Chrom/Chrome



Set doccia MONOCLASIC termostatica

Doccia fissa da Ø 260 mm. Doccia anticalcare. Flessibile doppia graffatura.
Asta telescopica

Termostatický sprchový set MONOCLASIC

Hlavová sprcha Ø 260 mm. Sprchová koncovka se systémem proti tvorbě vodního kamene.
Hadice s dvojitým opletem. Tyč s teleskopickou regulací výšky.

Wall thermostatic shower mixer MONOCLASIC

Fixed shower head Ø 260 mm. Shower Antilime.
Double interlocked shower hose. Telescopic bar

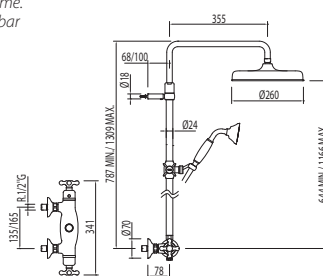

Cr	032.195.02
Lv	032.195.02.LV



Set doccia MONOCLASIC termostatica

Doccia fissa da Ø 260 mm. Asta telescopica

Termostatický sprchový set MONOCLASIC

Hlavová sprcha Ø 260 mm. Tyč s teleskopickou regulací výšky.

Wall thermostatic shower mixer MONOCLASIC

Fixed shower head Ø 260 mm. Telescopic bar

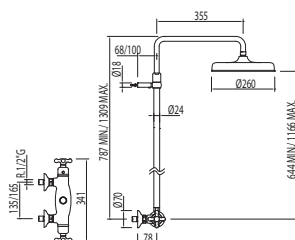

Cr	032.164.03
Lv	032.164.03.LV



Kit doccia termostatica MONOCLASIC

Asta antiscivolo lungo 550 mm. Doccia anticalcare.
Flessibile doppia graffatura.

Termostatický sprchový set MONOCLASIC

Posuvná tyč délka 550 mm. Sprchová koncovka se systémem proti tvorbě vodního kamene. Hadice s dvojitým opletem.

Thermostatic bar-shower MONOCLASIC



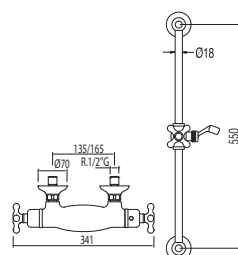





Sliding bar long. 550 mm. Shower Antilime. Double interlocked shower hose.



Cr	032.164.02
Lv	032.164.02.LV

MONOCLASIC 1900

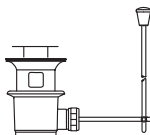
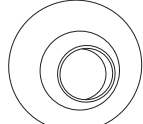
Ricambi / Náhradní díly / Spare parts

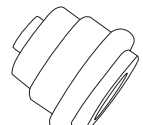
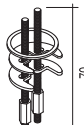
 <p>Manopola Úchyt Lever</p> <table border="1"> <tr><td>Cr</td><td>91.34.100.10.0</td><td></td></tr> <tr><td>Lv</td><td>91.34.100.15.1</td><td></td></tr> <tr><td>Ac</td><td>91.34.100.15.3</td><td></td></tr> </table>	Cr	91.34.100.10.0		Lv	91.34.100.15.1		Ac	91.34.100.15.3		 <p>Invertitore automatico Automatický přepínač Diverter</p> <table border="1"> <tr><td>Cr</td><td>91.42.250</td><td></td></tr> <tr><td>Lv</td><td>91.42.250.05.1</td><td></td></tr> <tr><td>Ac</td><td>91.42.250.05.3</td><td></td></tr> </table>	Cr	91.42.250		Lv	91.42.250.05.1		Ac	91.42.250.05.3	
Cr	91.34.100.10.0																		
Lv	91.34.100.15.1																		
Ac	91.34.100.15.3																		
Cr	91.42.250																		
Lv	91.42.250.05.1																		
Ac	91.42.250.05.3																		
 <p>Indicatore Zátka s označením teploty Index</p> <table border="1"> <tr><td>Cr</td><td>91.42.100</td><td></td></tr> <tr><td>Lv</td><td>91.42.100.05.1</td><td></td></tr> <tr><td>Ac</td><td>91.42.100.05.3</td><td></td></tr> </table>	Cr	91.42.100		Lv	91.42.100.05.1		Ac	91.42.100.05.3		 <p>Rompigetto lavabo Perlátor pro umyvadlo Basin aerator</p> <p>(per ref. / Kód / for Nr.: 42.103, 47.103)</p> <table border="1"> <tr><td>Cr</td><td>92.42.103</td><td></td></tr> <tr><td>Lv</td><td>92.42.103.05.1</td><td></td></tr> <tr><td>Ac</td><td>92.42.103.05.3</td><td></td></tr> </table>	Cr	92.42.103		Lv	92.42.103.05.1		Ac	92.42.103.05.3	
Cr	91.42.100																		
Lv	91.42.100.05.1																		
Ac	91.42.100.05.3																		
Cr	92.42.103																		
Lv	92.42.103.05.1																		
Ac	92.42.103.05.3																		
 <p>Cappuccio Kryt Lid</p> <table border="1"> <tr><td>Cr</td><td>91.42.120</td><td></td></tr> <tr><td>Lv</td><td>91.42.120.05.1</td><td></td></tr> <tr><td>Ac</td><td>91.42.120.05.3</td><td></td></tr> </table>	Cr	91.42.120		Lv	91.42.120.05.1		Ac	91.42.120.05.3		 <p>Rompigetto vasca Perlátor pro vanu Bathtub aerator</p> <p>(per ref. / Kód / for Nr.: 42.170)</p> <table border="1"> <tr><td>Cr</td><td>92.42.170</td><td></td></tr> <tr><td>Lv</td><td>92.42.170.05.1</td><td></td></tr> <tr><td>Ac</td><td>92.42.170.05.3</td><td></td></tr> </table>	Cr	92.42.170		Lv	92.42.170.05.1		Ac	92.42.170.05.3	
Cr	91.42.120																		
Lv	91.42.120.05.1																		
Ac	91.42.120.05.3																		
Cr	92.42.170																		
Lv	92.42.170.05.1																		
Ac	92.42.170.05.3																		
 <p>Base per lavabo e bidet Ozdobný kroužek pod umyvadlovou baterii Washbasin mixer base</p> <table border="1"> <tr><td>Cr</td><td>91.42.120.02</td><td></td></tr> <tr><td>Lv</td><td>91.42.120.25.1</td><td></td></tr> <tr><td>Ac</td><td>91.42.120.25.3</td><td></td></tr> </table>	Cr	91.42.120.02		Lv	91.42.120.25.1		Ac	91.42.120.25.3		 <p>Scarico automatico Automatický odtok Pup-up waste</p> <p>1,1/4"</p> <table border="1"> <tr><td>Cr</td><td>91.42.840.30</td><td></td></tr> <tr><td>Lv</td><td>91.42.840.35.1</td><td></td></tr> <tr><td>Ac</td><td>91.42.840.35.3</td><td></td></tr> </table>	Cr	91.42.840.30		Lv	91.42.840.35.1		Ac	91.42.840.35.3	
Cr	91.42.120.02																		
Lv	91.42.120.25.1																		
Ac	91.42.120.25.3																		
Cr	91.42.840.30																		
Lv	91.42.840.35.1																		
Ac	91.42.840.35.3																		
 <p>Rosone Rozeta Cover plate</p> <table border="1"> <tr><td>Cr</td><td>91.42.170.02</td><td></td></tr> <tr><td>Lv</td><td>91.42.170.25.1</td><td></td></tr> <tr><td>Ac</td><td>91.42.170.25.3</td><td></td></tr> </table>	Cr	91.42.170.02		Lv	91.42.170.25.1		Ac	91.42.170.25.3		 <p>Set asta e pulsante Sada přepínače s vedením a úchytem Button and rod set</p> <table border="1"> <tr><td>Cr</td><td>91.42.840.02</td><td></td></tr> <tr><td>Lv</td><td>91.42.840.25.1</td><td></td></tr> <tr><td>Ac</td><td>91.42.840.25.3</td><td></td></tr> </table>	Cr	91.42.840.02		Lv	91.42.840.25.1		Ac	91.42.840.25.3	
Cr	91.42.170.02																		
Lv	91.42.170.25.1																		
Ac	91.42.170.25.3																		
Cr	91.42.840.02																		
Lv	91.42.840.25.1																		
Ac	91.42.840.25.3																		
 <p>Rotula Bidetové klouby Ball-and-socket joint bidet mixer</p> <table border="1"> <tr><td>Cr</td><td>91.42.677.02</td><td></td></tr> <tr><td>Lv</td><td>91.42.677.25.1</td><td></td></tr> <tr><td>Ac</td><td>91.42.677.25.3</td><td></td></tr> </table>	Cr	91.42.677.02		Lv	91.42.677.25.1		Ac	91.42.677.25.3		 <p>Set fissaggio Montážní sada Locking set</p> <table border="1"> <tr><td></td><td>96.42.103.20</td><td></td></tr> </table>		96.42.103.20							
Cr	91.42.677.02																		
Lv	91.42.677.25.1																		
Ac	91.42.677.25.3																		
	96.42.103.20																		

□ CLASIC-TRES

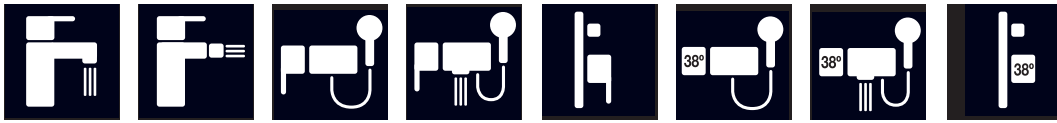

5.37.104.01



1.37.103



032.164.09

CLASIC-TRES

CLASIC-TRES

Lavabi / Umyvadla / Basins

Ref. / Kód / Nr.:



Monoblocco lavabo
 Umyvadlová baterie
 Single hole wash-basin mixer



	Cr	1.32.104	
	Lv	5.32.104.01	

	Cr	1.37.104	
	Lv	5.37.104.01	



Rubinetto lavabo da 1/2"
 Umyvadlový kohoutek 1/2"
 1/2" basin pillar tap

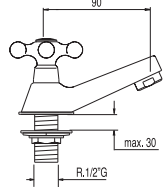

	Cr	F	1.32.100.F	
	Cr	C	1.32.100.C	



Monoblocco lavabo
 Umyvadlová baterie
 Single hole wash-basin mixer

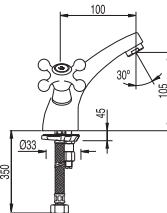

	Cr	1.32.103	
	Cr	1.37.103	

CLASIC-TRES

Ref. / Kód / Nr.:

Accumulatore lavabo

Umyvadlová baterie

Wash-basin mixer

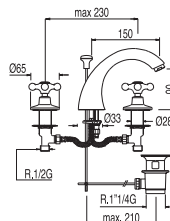

Cr
Lv

1.37.106
5.37.106.01



Rubinetto laterale uscita filettata 3/4"

Postranní ventil
výstup se závitem 3/4"

Lateral tap
threaded outlet 3/4"

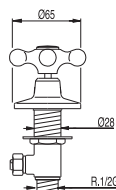

Cr F

1.32.510.F



Cr C

1.32.510.C

Bidet / Bidety / Bidets

Ref. / Kód / Nr.:

Monoblocco bidet

Bidetová baterie

Single hole bidet mixer

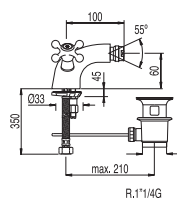

Cr

1.32.120



Cr

1.37.120



Monoblocco bidet

Bidetová baterie

Single hole bidet mixer

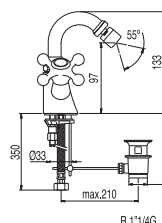

Cr
Lv

1.32.124
5.32.124.01



Cr
Lv

1.37.124
5.37.124.01



Accumulatore bidet con doccia

Bidetová baterie s ruční
sprchou

Single hole bidet mixer

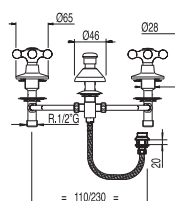

Cr

1.32.130

Cr = Cromo/Chrom/Chrome Lv = Ottone antico/stará mosaz/Old brass

F = Fredda/Studená/Cold C = Calda/Teplá/Hot

Ref. / Kód / Nr.:



Rubinetto bidet da 1/2"
Bidetový kohoutek 1/2"
Bidet 1/2"

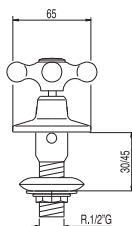

Cr **F** 1.32.125.F
Lv **F** 5.32.125.01.F



Cr **C** 1.32.125.C
Lv **C** 5.32.125.01.C

Doppi comandi bagno / Vanové baterie s dvoupákovým mechanismem / Bathroom dual control taps

Ref. / Kód / Nr.:



Gruppo doccia
Doccia anticalcare. Flessibile doppia graffatura

Sprchová baterie
Sprchová koncovka se systémem proti tvorbě vodního kamene, hadice s dvojitým opletem

Shower mixer
Shower Antilime. Double interlocked shower hose

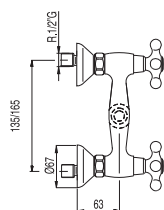

Cr 1.32.768
Lv 5.32.765.01



Gruppo vasca
Doccia anticalcare. Flessibile doppia graffatura

Vanová baterie
Sprchová koncovka se systémem proti tvorbě vodního kamene, hadice s dvojitým opletem

Bath and shower mixer
Shower Antilime. Double interlocked shower hose

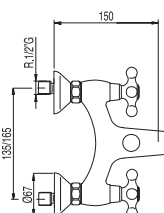

Cr 1.32.774
Lv 5.32.771.01



Gruppo vasca
Doccia anticalcare. Flessibile doppia graffatura

Vanová baterie
Sprchová koncovka se systémem proti tvorbě vodního kamene, hadice s dvojitým opletem

Bath and shower mixer
Shower Antilime. Double interlocked shower hose

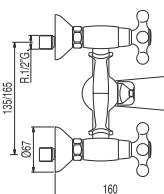

Cr 1.32.176
Lv 5.32.176.01

Cr = Cromo/Chrom/Chrome Lv = Ottone antico/stará mosaz/Old brass

F = Fredda/Studená/Cold **C** = Calda/Teplá/Hot

CLASIC-TRES

Elementi per doccia / Sprchové prvky / Shower parts

Ref. / Kód / Nr.:



Asta antiscivolo CLASIC
 Posuvná tyč CLASIC
 Sliding bar CLASIC

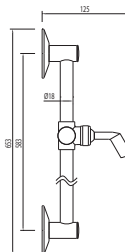

Cr	1.34.734
Lv	5.34.734.01



Asta telescopica CLASIC
 Doccia fissa Ø 260 mm.
 Tyč s teleskopickou regulací výšky CLASIC
 Pevná sprcha Ø 260 mm.
 Telescopic bar CLASIC
 fixed shower head Ø 260 mm.

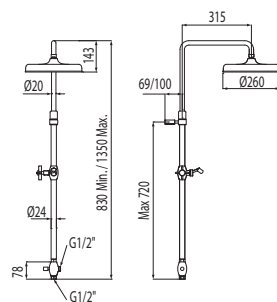

Esclusivamente per bicomando e monocomando
 Výhradní Dřezová
 Only for mixers and single lever mixers

Cr	024.213.01
Lv	024.213.01.LV



2 prese da terra da vasca CLASIC
 2 podlahové přípojky k vanovým
 bateriím CLASIC
 2-outlet bathtub base CLASIC

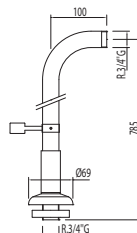

Cr	1.24.194
Lv	024.194.01.LV



Gomito adattabile vasca
 Koleno k vanové baterii
 Adaptable elbow

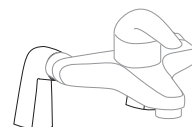
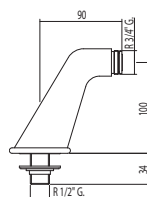

con silenziatore
 do zdi s gumovými tlumiči
 with silencer

Cr	024.871.01
Lv	024.871.01.LV

Cr = Cromo/Chrom/Chrome Lv = Ottone antico/stará mosaz/Old brass

Gruppi ad incasso / Vestavěné soupravy / Built-in sets Ref. / Kód / Nr.:



Accumulatore bagno tubo fuso da 11 cm.
 Vanová baterie litá výtoková hubice 11 cm.
Bath and shower mixer Cast spout 11 cm.

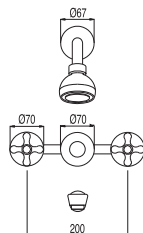

Cr	1.32.151	
----	----------	--

Bordovasca / Vany s prodlouženým pultem / Deck-mounted bathtubs Ref. / Kód / Nr.:



Batteria bordo vasca con invertitore
 Stojánková vanová baterie víceotvorová s přepínačem
Bath and shower mixer for bracket shelf

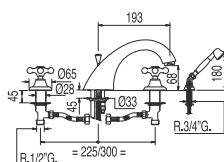

Cr	1.32.145	
Lv	5.32.145.01	



Kit bordo vasca
 Facile montaggio superiore. Senza registro
 Montážní sada k 3-otvorové baterii s odtokem zbytků vody
 Snadná montáž/demontáž seshora.
 Není nutné montovat dodatečné revizní prvky u vany
Bath-shower kit cistern easy upper assembly, without installation

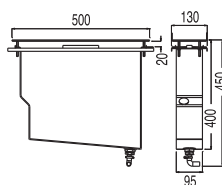

Brevettato®
 Patentovaný®
 Patented®

Cr	1.34.345	
----	----------	--



Valvola vasca con presa drenaggio
 Vanový sifon typu click-clack s přípojkou k odtokovému systému 3-otvorové baterie
Bath valve with drainage point

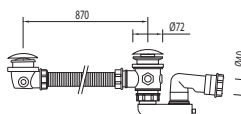

Cr	1.34.445	
----	----------	--

CLASIC-TRES

Termostatiche / Termostatické / Thermostatically-controlled

Ref. / Kód / Nr.:



Doccia CLASIC termostatica

Flessibile doppia graffatura e flessibile satinato.

Termostatický vanový CLASIC
Sprchová hadice s dvojitým opletem

Wall thermostatic shower mixer CLASIC
double interlocked shower hose

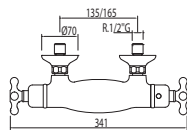

Cr 032.164.09
Lv 032.164.09.LV



Bagno doccia CLASIC termostatica

Flessibile doppia graffatura e flessibile satinato.

Termostatická vanová baterie CLASIC
Sprchová hadice s dvojitým opletem

Wall thermostatic bath and shower mixer CLASIC
double interlocked shower hose

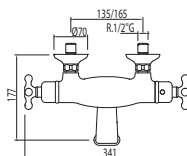

Cr 032.174.09
Lv 032.174.09.LV



Bagno doccia CLASIC termostatica

Flessibile doppia graffatura e flessibile satinato.

Termostatická vanová baterie CLASIC
Sprchová hadice s dvojitým opletem

Wall thermostatic bath and shower mixer CLASIC
double interlocked shower hose

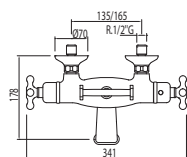

Cr 032.176.09
Lv 032.176.09.LV

Gruppi termostatici / Termostatické soupravy / Thermostatically-controlled sets

Ref. / Kód / Nr.:



Set doccia CLASIC termostatica

Doccia fissa da Ø 260 mm. Doccia anticalcare (91.34.824).
Flessibile doppia graffatura (91.34.828).

Termostatický sprchový set CLASIC

Hlavová sprcha Ø 260 mm. Sprchová koncovka se systémem proti tvorbě vodního kamene (91.34.824). Hadice s dvojitým opletem (91.34.828).

Wall thermostatic shower mixer CLASIC
Fixed shower head Ø 260 mm. Shower Antilime (91.34.824).
Double interlocked shower hose (91.34.828).

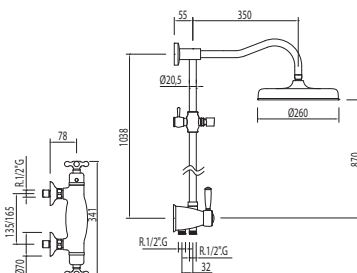

Cr 032.195.01

Cr = Cromo/Chrom/Chrome



Set doccia CLASIC termostatica

Doccia fissa da Ø 260 mm. Doccia anticalcare. Flessibile doppia graffatura.. Asta telescopica

Termostatický sprchový set CLASIC

Hlavová sprcha Ø 260 mm. Sprchová koncovka se systémem proti tvorbě vodního kamene. Hadice s dvojitým opletem. Tyč s teleskopickou regulací výšky.

Wall thermostatic shower mixer CLASIC

Fixed shower head Ø 260 mm. Shower Antilime. Double interlocked shower hose. Telescopic bar

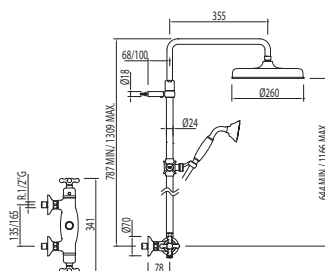

Cr	032.195.02
Lv	032.195.02.LV



Set doccia CLASIC termostatica

Doccia fissa da Ø 260 mm. Asta telescopica

Termostatický sprchový set CLASIC

Hlavová sprcha Ø 260 mm. Tyč s teleskopickou regulací výšky.

Wall thermostatic shower mixer CLASIC

Fixed shower head Ø 260 mm. Telescopic bar

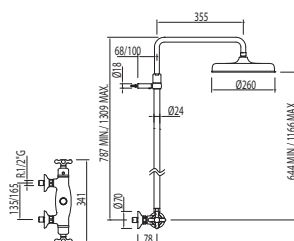

Cr	032.164.03
Lv	032.164.03.LV



Kit doccia termostatica CLASIC

Asta antiscivolo lungo 550 mm. Doccia anticalcare. Flessibile doppia graffatura.

Termostatický sprchový set CLASIC

Posuvná tyč délka 550 mm. Sprchová koncovka se systémem proti tvorbě vodního kamene. Hadice s dvojitým opletem.

Thermostatic bar-shower CLASIC

Sliding bar long. 550 mm. Shower Antilime. Double interlocked shower hose.

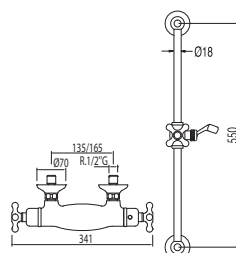

Cr	032.164.02
Lv	032.164.02.LV

CLASIC-TRES

Rubinetti di arresto / Průchozí ventily / Shutoff valves

Ref. / Kód / Nr.:



Rubinetto di arresto filettato 1/2"
 Ventil se závitem 1/2"
 1/2" threaded-ends gate-valve

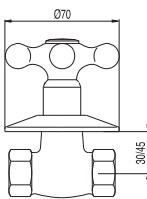

Cr	F	1.33.155.F
Lv	F	5.33.155.01.F



Cr	C	1.33.155.C
Lv	C	5.33.155.01.C



Rubinetto di arresto filettato 3/4"
 Ventil se závitem 3/4"
 3/4" threaded-ends gate-valve

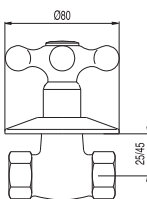

Cr	F	1.33.157.F
Lv	F	5.33.157.01.F



Cr	C	1.33.157.C
Lv	C	5.33.157.01.C

Ricambi / Náhradní díly / Spare parts

	Crocetta con indicatore Otočný ovladač s označením teploty <i>Handle with index</i>	Cr 91.34.004.10 Cr 91.34.004.20 Lv 91.34.004.15.1 Lv 91.34.004.15.2		Scarico automatico Automatický odtok <i>Pup-up waste</i>	1,1/4" Lv 91.34.840.55.1
	Indice per volano n°4 Zátka s označením teploty k otočnému ovladači č. 4 <i>Index for handle Nr 4</i>	Cr 91.34.004.01 Cr 91.34.004.02 Lv 91.34.004.75.1 Lv 91.34.004.85.1		Set asta e pulsante Sada přepínače s vedením a úchytem <i>Button and rod set</i>	Lv 91.34.840.35.1
	Cappuccio crocetta Kryt hlavy pod otočným ovladačem <i>Handles</i>	Cr 91.34.004.03 Lv 91.34.004.35.1		Montaggio ceramica Hlava keramika <i>Cartridge ceramic</i>	(per ref. / Kód / for Nr.: 32.100, 32.103, 37.103, 32.104, 37.104, 32.120, 37.120, 32.124, 37.124, 32.768, 32.765, 32.774, 32.766, 32.771, 32.772, 32.176, 32.317, 32.335, 32.342, 32.440, 32.416) 1/2"
	Rotula Bidetové klouby <i>Ball-and-socket joint bidet mixer</i>	(per ref. / Kód / for Nr.: 124) Cr 91.34.477 Lv 91.34.477.05.1		Montaggio ceramica Hlava keramika <i>Cartridge ceramic</i>	(per ref. / Kód / for Nr.: 37.106, 32.125, 32.145, 32.510, 32.130, 32.151) 1/2" 91.34.292
	Invertitore automatico Automatický přepínač <i>Diverter</i>	Cr 91.34.256 Lv 91.34.256.25.1		Montaggio Hlava <i>Cartridge</i>	1/2" 91.34.293 91.34.296
	Invertitore automatico Automatický přepínač <i>Diverter</i>	(per ref. / Kód / for Nr.: 33.176, 32.176) Cr 91.34.176 Lv 91.34.176.05.1		Montaggio Hlava <i>Cartridge</i>	3/4" 91.34.297
	Scarico automatico Automatický odtok <i>Pup-up waste</i>	Cr 91.34.840.57		Set asta e pulsante Sada přepínače s vedením a úchytem <i>Button and rod set</i>	Cr 91.34.840.07

RETRO-TRES





54

□ RETRO-TRES



1.29.103.61



1.29.120.61

RETRO-TRES





024.164.04

RETRO-TRES



RETRO-TRES

Lavabi / Umyvadla / Basins

Ref. / Kód / Nr.:

Monoblocco lavabo
 Umyvadlová baterie
 Single hole wash-basin mixer

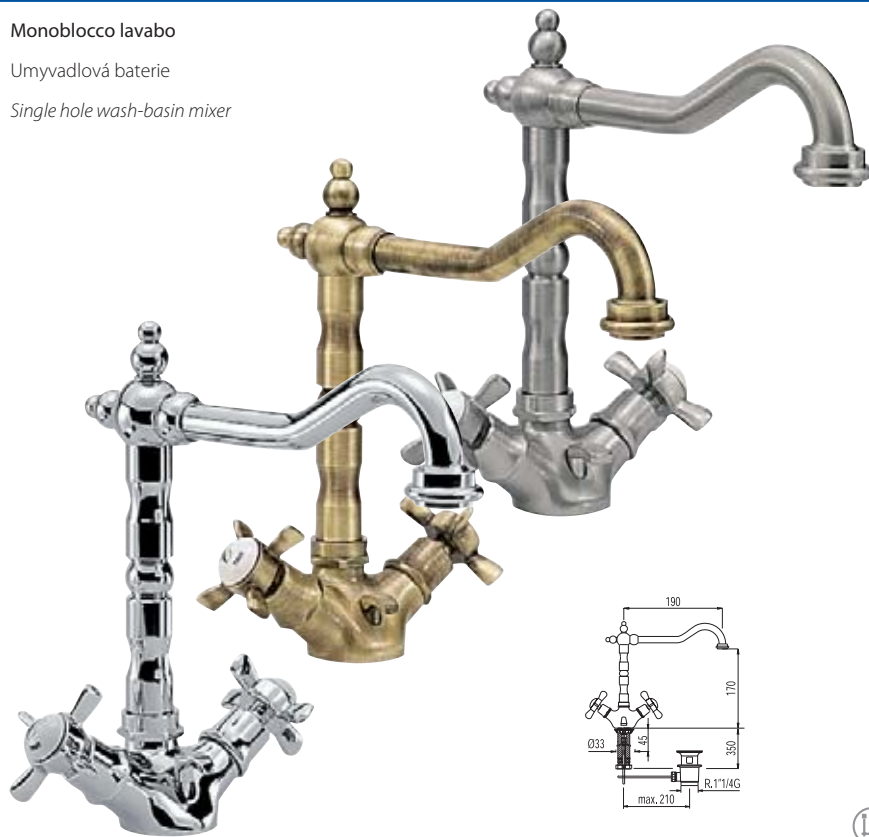

Cr	1.29.104.61
Lv	5.29.104.01.61
Ac	5.29.104.03.61



Monoblocco lavabo
 Bidetová baterie
 Single hole wash-basin mixer

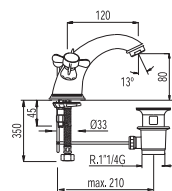

Cr	1.29.103.61
Lv	5.29.103.01.61
Ac	5.29.103.03.61



Accumulatore lavabo
 Umyvadlová baterie
 Wash-basin mixer

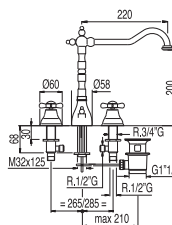

Cr	1.29.105.61
Lv	5.29.105.01.61
Ac	5.29.105.03.61



Accumulatore lavabo
 Umyvadlová baterie
 Wash-basin mixer

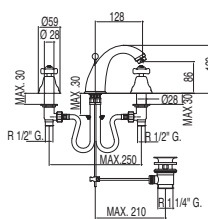

Cr	1.29.106
Lv	5.29.106.01

Cr = Cromo/Chrom/Chrome Lv = Ottone antico/stará mosaz/Old brass Ac = Acciaio/Kartáčovaná ocel/Steel

Ref. / Kód / Nr.:

Accumulatore lavabo a muro

Nastěnná umyvadlová baterie

Wash-basin mixer

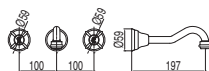

Cr	1.24.151
Lv	5.24.151.01

Rubinetto laterale

Postranní ventil

Lateral tap

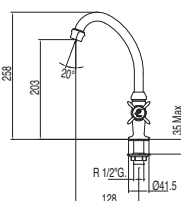

Cr	1.24.306
----	----------

Rubinetto lavabo 1 acqua

Umyvadlová baterie pro studenou nebo smíšenou vodu

Basin pillar tap only cold water

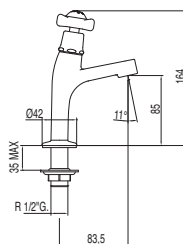

Cr	1.24.503
----	----------

Bidet / Bidety / Bidets

Ref. / Kód / Nr.:

Monoblocco bidet

Bidetová baterie

Single hole bidet mixer

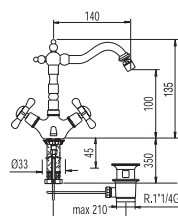

Cr	1.29.124.61
Lv	5.29.124.01.61
Ac	5.29.124.03.61

Monoblocco bidet

Sprchová baterie

Single hole bidet mixer

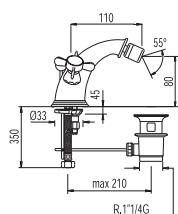

Cr	1.29.120.61
Lv	5.29.120.01.61
Ac	5.29.120.03.61

RETRO-TRES

Doppi comandi bagno / Vanové baterie s dvoupákovým mechanismem / Bathroom dual control taps

Ref. / Kód / Nr.:



Gruppo doccia

Eccentrico con silenziatore.
Doccia anticalcare.
Flessibile doppia graffatura

Sprchová baterie

Excentrické propojky do zdi s gumovými tlumiči. Ruční sprchy se systémem proti vzniku vodního kamene. Sprchová hadice s dvojitým opletem.

Shower mixer

Excentric union with silencer.
Antilime hand shower

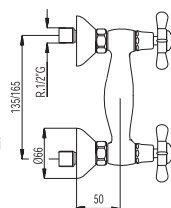

Cr	1.24.167.61
Lv	5.24.167.01.61
Ac	5.24.167.03.61



Gruppo vasca

Eccentrico con silenziatore.
Doccia anticalcare.
Flessibile doppia graffatura

Vanová baterie

Excentrické propojky do zdi s gumovými tlumiči. Ruční sprchy se systémem proti vzniku vodního kamene. Sprchová hadice s dvojitým opletem.

Bath and shower mixer

Excentric union with silencer.
Antilime hand shower

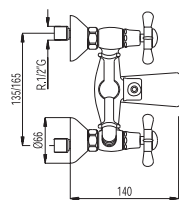

Cr	1.24.170.61
Lv	5.24.170.01.61
Ac	5.24.170.03.61

Elementi per doccia / Sprchové prvky / Shower parts

Ref. / Kód / Nr.:



Asta telescopica RETRO

Doccia fissa Ø 260 mm.

Tyč s teleskopickou regulací výšky RETRO

Pevná sprcha Ø 260 mm.

Telescopic bar RETRO

fixed shower head Ø 260 mm.

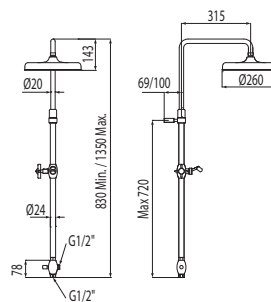

Esclusivamente per bicomando e monocomando
Výhradní Dřezová
Only for mixers and single lever mixers

Cr	024.213.01
Lv	024.213.01.LV

Cr = Cromo/Chrom/Chrome Lv = Ottone antico/stará mosaz/Old brass Ac = Acciaio/Kartáčovaná ocel/Steel

Ref. / Kód / Nr.:



Asta antiscivolo RETRO

Posuvná tyč RETRO

Sliding bar RETRO

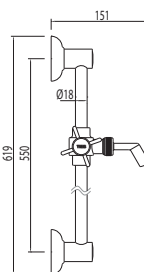

Cr	1.34.732
Lv	5.34.732.01
Ac	5.34.732.03



2 prese da terra da vasca RETRO

2 podlahové přípojky k vanovým bateriím RETRO

2-outlet bathtub base RETRO

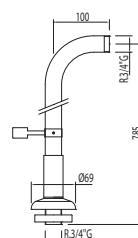

Cr	1.24.194
Lv	024.194.01.LV



Gomito adattabile vasca

Koleno k vanové baterii

Adaptable elbow

con silenziatore
do zdi s gumovými tlumiči
with silencer

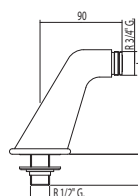

Cr	024.871.01
Lv	024.871.01.LV



Doccia anticalcare RETRO

Ruční sprcha se systémem proti vzniku vodního kamene RETRO

Antilime shower RETRO

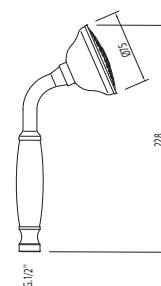

Cr	1.24.824
Lv	5.24.824.01



Canna RETRO

Výtoková hubice RETRO

Spout RETRO

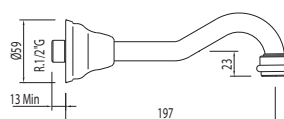

Cr	1.24.173
Lv	5.24.173.01

RETRO-TRES

Ad incasso / Vestavěné / Built-in

Ref. / Kód / Nr.:



Monocomando ad incasso doccia
Podomítková sprchová baterie
Single lever concealed shower mixer

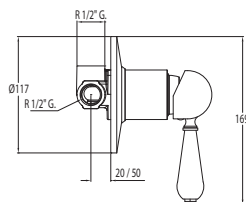

91.34.290

Cr

024.177.12



Monocomando incasso bagno doccia con deviatore
Podomítková vanová baterie s ruční sprchou
Single lever concealed bath and shower mixer

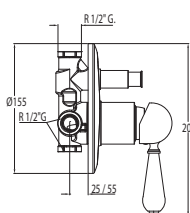

91.34.290

Cr

024.180.12

Kit per doccia grande formato / Sprchové soupravy velkých rozměrů / Large-size shower kits

Ref. / Kód / Nr.:



Idrodoccia RETRO
doccia fissa da Ø 260 mm. doccia anticalcare.
Asta telescopica.

Sprchovy a vanový set RETRO
Hlavová sprcha Ø 260 mm. Tyč s teleskopickou regulací výšky.

Wall bath mixer RETRO
fixed shower head Ø 260 mm. antilime hand shower.
Telescopic bar.

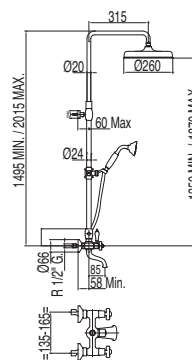

Cr

1.24.290.7

Lv

5.24.290.7.01



Set monocomando ad incasso con doccia RETRO
doccia fissa da Ø 260 mm. doccia anticalcare.
Asta telescopica.

Podomítkový set se sprchou RETRO
Hlavová sprcha Ø 260 mm. Tyč s teleskopickou regulací výšky.

Bar-shower RETRO set
fixed shower head Ø 260 mm. antilime hand shower.
Telescopic bar.

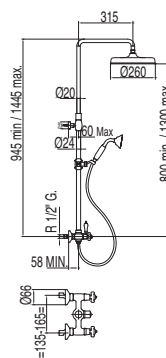

Cr

1.24.280.7

Lv

5.24.280.7.01

Cr = Cromo/Chrom/Chrome Lv = Ottone antico/stará mosaz/Old brass

Bordovasca / Vany s prodlouženým pultem / Deck-mounted bathtubs

Ref. / Kód / Nr.:

**Batteria bordo vasca
con invertitore**

 Stojánková vanová baterie
víceotvorová
s přepínačem

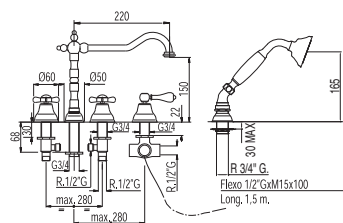
*Bath and shower mixer for
bracket shelf
inverter*

Cr	1.24.145.61
Lv	5.24.145.01.61

**Batteria bordo vasca
con invertitore**

 Stojánková vanová baterie
víceotvorová
s přepínačem

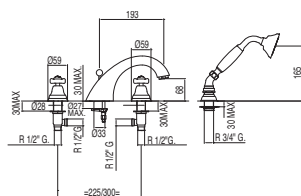
*Bath and shower mixer for
bracket shelf
inverter*

Cr	1.24.146
Lv	5.24.146.01

RETRO-TRES

Termostatiche / Termostatické / Thermostatically-controlled

Ref. / Kód / Nr.:



Doccia RETRO termostatica

Doccia anticalcare. Flessibile doppia graffatura.

Termostatický vanový RETRO

Ruční sprchy se systémem proti vzniku vodního kamene. Sprchová hadice s dvojitým opletem.

Wall thermostatic shower mixer RETRO

Antilime hand shower. Double interlocked shower hose.

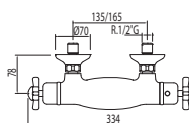

Cr 024.164.09
Lv 024.164.09.LV



Bagno doccia RETRO termostatica

Doccia anticalcare. Flessibile doppia graffatura.

Termostatická vanová baterie RETRO

Ruční sprchy se systémem proti vzniku vodního kamene. Sprchová hadice s dvojitým opletem.

Wall thermostatic bath and shower mixer RETRO

Antilime hand shower. Double interlocked shower hose.

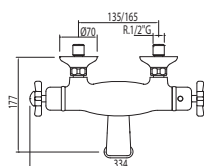

Cr 024.174.09
Lv 024.174.09.LV



Bagno doccia RETRO termostatica

Doccia anticalcare. Flessibile doppia graffatura.

Termostatická vanová baterie RETRO

Ruční sprchy se systémem proti vzniku vodního kamene. Sprchová hadice s dvojitým opletem.

Wall thermostatic bath and shower mixer RETRO

Antilime hand shower. Double interlocked shower hose.

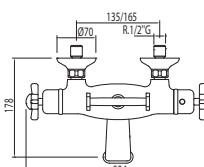

Cr 024.176.09
Lv 024.176.09.LV



Termostatica doccia completa con presa acqua a parete

Valvola antiritorno con chiusura orientabile. Flessibile doppia graffatura. Doccia anticalcare

Termostatická sprchová baterie s připojením do zdi

Ventily proti zpětnému toku s regulací směru montáže. Sprchová hadice s dvojitým opletem. Ruční sprchy se systémem proti vzniku vodního kamene.

Shower thermostatic completed with water connections to the wall

Bicuspid valve with orientable closure. Double interlocked shower hose. Antilime shower.

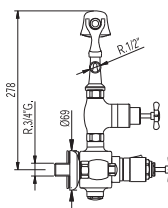

Cr 1.90.280
Lv 5.90.280.01



Termostatica vasca completa con presa di acqua a parete

Valvola antiritorno con chiusura orientabile. Flessibile doppia graffatura. Doccia anticalcare

Termostatická vanová baterie s připojením do zdi

Ventily proti zpětnému toku s regulací směru montáže. Sprchová hadice s dvojitým opletem. Ruční sprchy se systémem proti vzniku vodního kamene

Bath thermostatic completed with water connections to the wall

Bicuspid valve with orientable closure. Double interlocked shower hose. Antilime shower.

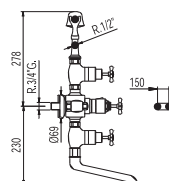

Cr 1.90.290
Lv 5.90.290.01

Cr = Cromo/Chrom/Chrome

Gruppi termostatici / Termostatické soupravy / Thermostatically-controlled sets

Ref. / Kód / Nr.:

Kit doccia termostatica RETRO

Con chiusura e regolazione di portata. (2 vie) Doccia fissa da Ø 260 mm. Supporto per doccia (024.182.01). Doccia anticalcarea (1.24.824). Flessibile doppia graffatura (91.34.828).

Termostatický sprchový set RETRO

S uzávěrem a regulací průtoku. (Dvoucestný) Hlavová sprcha Ø 260 mm. Pevný držák s vodní přípojkou pro hadici (024.182.01). Sprchová koncovka se systémem proti tvorbě vodního kamene (1.24.824). Hadice s dvojitým opletem (91.34.828).

Thermostatic bar-shower RETRO

with water shut off and flow control. (2 ways) Fixed shower head Ø 260 mm. Elbow wall (024.182.01). Shower Antilime (1.24.824). Double interlocked shower hose (91.34.828).

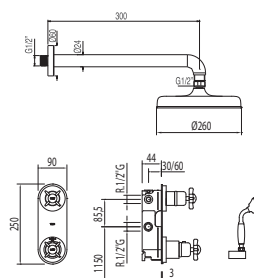

Cr 024.970.02

Set doccia RETRO termostatica

Doccia fissa da Ø 260 mm. Doccia anticalcarea (1.24.824). Flessibile doppia graffatura (91.34.828).

Termostatický sprchový set RETRO

Hlavová sprcha Ø 260 mm. Sprchová koncovka se systémem proti tvorbě vodního kamene (1.24.824). Hadice s dvojitým opletem (91.34.828).

Wall thermostatic shower mixer RETRO

Fixed shower head Ø 260 mm. Shower Antilime (1.24.824). Double interlocked shower hose (91.34.828).

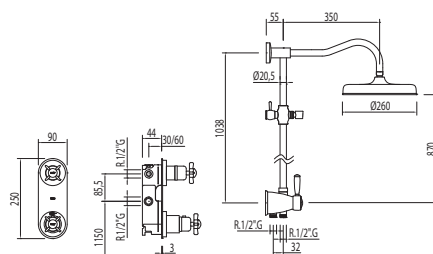

Cr 024.970.01

Termostatica doccia completa con presa acqua a parete

Valvola antiritorno con chiusura orientabile. Supporto doccia regolabile. Doccia fissa da Ø 260 mm. Flessibile doppia graffatura e flesso satinato. Asta telescopica

Termostatická sprchová baterie s připojením do zdi

Ventily proti zpětnému toku s regulací směru montáže. Držák ruční sprchy pohyblivý. Hlavová sprcha Ø 260 mm. Sprchová hadice s dvojitým opletem. Tyč s teleskopickou regulací výšky.

Shower Thermostatic completed with water connections to the wall

Bicuspid valve with orientable closure. Adjustable shower holder. Fixed shower head Ø 260 mm. double interlocked shower hose. Telescopic bar

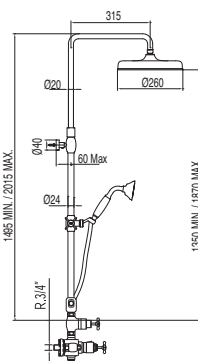
Attenzione: controllare le dimensioni

 Pozor: Zkontrolovat roz měry
 Attention: Check dimensions

 Cr 024.164.04
 Lv 024.164.04.LV



Termostatica vasca completa con presa di acqua a parete

Valvola antiritorno con chiusura orientabile. Supporto doccia regolabile. Doccia fissa da Ø 260 mm. Flessibile doppia graffatura e flesso satinato. Asta telescopica

Termostatická vanová baterie s pripojením do zdi
Ventily proti zpětnému toku s regulací směru montáže.
Držák ruční sprchy pohyblivý. Hlavová sprcha Ø 260 mm.
Sprchová hadice s dvojitým opletem. Tyč s teleskopickou regulací výšky.

Thermostatic bath completed with water connections to the wall

Bicuspid valve with orientable closure. Adjustable shower holder. Fixed shower head Ø 260 mm, double interlocked shower hose. Telescopic bar

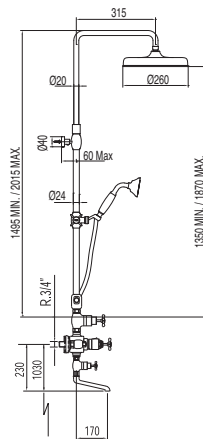

Attenzione: controllare le dimensioni
Pozor: Zkontrolovat roz měry
Attention: Check dimensions



Cr	024.174.02
Lv	024.174.02.LV

Set doccia RETRO termostatica

Doccia fissa da Ø 260 mm. Doccia anticalcarea (91.34.824). Flessibile doppia graffatura (91.34.828).

Termostatický sprchový set RETRO

Hlavová sprcha Ø 260 mm. Sprchová koncovka se systémem proti tvorbě vodního kamene (91.34.824). Hadice s dvojitým opletem (91.34.828).

Wall thermostatic shower mixer RETRO

Fixed shower head Ø 260 mm. Shower Antilime (91.34.824). Double interlocked shower hose (91.34.828).

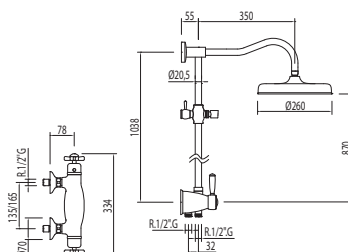

Cr	024.195.01
----	------------

Set doccia RETRO termostatica

doccia fissa da Ø 260 mm. Flessibile doppia graffatura e flesso satinato. Asta telescopica

Termostatický sprchový set RETRO

Hlavová sprcha Ø 260 mm. Sprchová hadice s dvojitým opletem. Tyč s teleskopickou regulací výšky.

Wall thermostatic shower mixer RETRO

fixed shower head Ø 260 mm. double interlocked shower hose. Telescopic bar

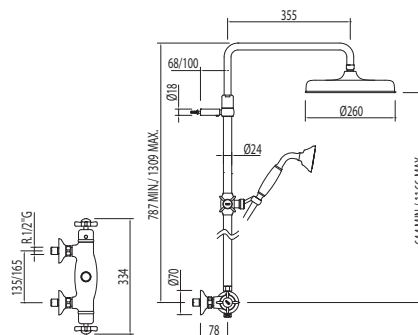

Cr	024.195.02
Lv	024.195.02.LV



Set doccia RETRO termostatica
doccia fissa da Ø 260 mm. Asta telescopica

Termostatický sprchový set RETRO
Hlavová sprcha Ø 260 mm. Tyč s teleskopickou regulací výšky.

Wall thermostatic shower mixer RETRO fixed shower head Ø 260 mm. Telescopic bar

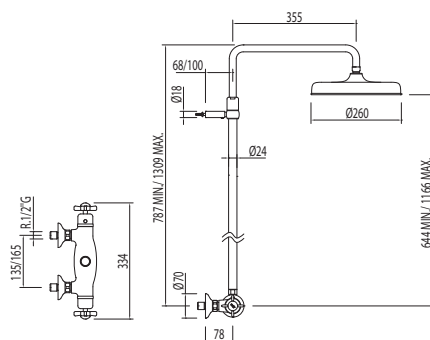

Cr	024.164.03	
Lv	024.164.03.LV	



Termostatica vasca completa con presa di acqua a pavimento
Valvola antiritorno con chiusura orientabile. Flessibile doppia graffatura. Doccia anticalcare.

Termostatická vanová baterie s přípojkami k podlaze
Ventily proti zpětnému toku s regulací směru montáže. Sprchová hadice s dvojitým opletem. Ruční sprchy se systémem proti vzniku vodního kamene

*Thermostatic bath completed with water tubes to the floor
Bicuspid valve with orientable closure. double interlocked shower hose. Antilime showers.*

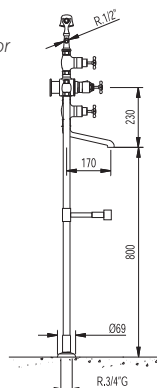

Attenzione: controllare le dimensioni
Pozor: Zkontrolovat roz měry
Attention: Check dimensions

Cr	1.90.194	
Lv	5.90.194.01	

Kit doccia termostatica RETRO
Flessibile doppia graffatura e flesso satinato. Asta antiscivolo

Termostatický sprchový set RETRO
Sprchová hadice s dvojitým opletem. Posuvná

*Thermostatic bar-shower RETRO
double interlocked shower hose. Sliding bar*

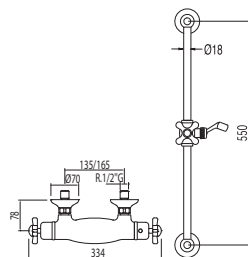

Cr	024.164.02	
Lv	024.164.02.LV	

RETRO-TRES

Miscellanea / Různé / Miscellaneous

Ref. / Kód / Nr.:



Rubinetto office
Kuchyňská baterie
Kitchenette tap

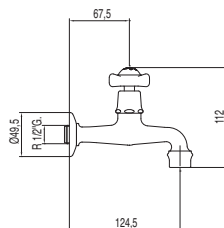

Cr 1.24.520



Rubinetto lavatrice
3/4" Avvitare
Baterie pro pračku
3/4" Zašroubovat
Washing machine tap
3/4" Screw

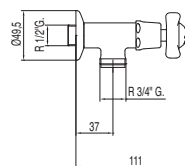

Cr 1.24.500



Rubinetto laterale
Postranní ventil
Lateral tap

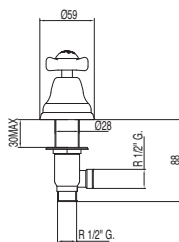

Cr F 1.24.125.F
Lv F 5.24.125.01.F

Cr C 1.24.125.C
Lv C 5.24.125.01.C



Rubinetto di arresto filettato
Ventil se závitem
Valve

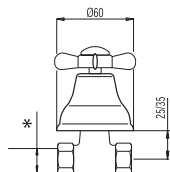

1/2"

3/4"











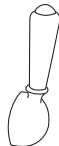

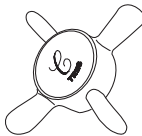
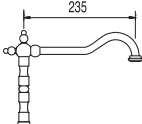

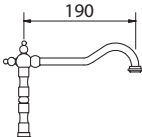
Cr F 1.24.155.61.F
Lv F 5.24.155.01.61.F

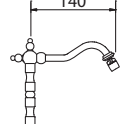
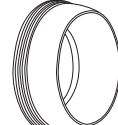
Cr C 1.24.155.61.C
Lv C 5.24.155.01.61.C

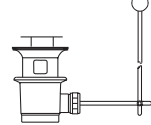
Cr F 1.24.157.61.F
Lv F 5.24.157.01.61.F

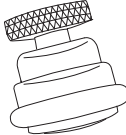
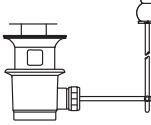
Cr C 1.24.157.61.C
Lv C 5.24.157.01.61.C

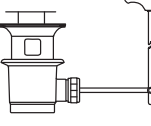
Ricambi / Náhradní díly / Spare parts

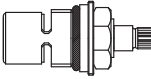
<p>Manopola Úchyt <i>Lever</i></p>  <p>(per ref. / Kód / for Nr.: 24.177, 24.180)</p> <table border="1"> <tr><td>Cr</td><td>91.34.062.200</td><td></td></tr> </table> <p>(per ref. / Kód / for Nr.: 24.341)</p> <table border="1"> <tr><td>Cr</td><td>91.34.062.10.0</td><td></td></tr> <tr><td>Lv</td><td>91.34.062.15.1</td><td></td></tr> <tr><td>Ac</td><td>91.34.062.15.3</td><td></td></tr> </table> <p>(per ref. / Kód / for Nr.: 24.334)</p> <table border="1"> <tr><td>Cr</td><td>91.34.162.10.0</td><td></td></tr> <tr><td>Lv</td><td>91.34.162.15.1</td><td></td></tr> <tr><td>Ac</td><td>91.34.162.15.3</td><td></td></tr> </table>	Cr	91.34.062.200		Cr	91.34.062.10.0		Lv	91.34.062.15.1		Ac	91.34.062.15.3		Cr	91.34.162.10.0		Lv	91.34.162.15.1		Ac	91.34.162.15.3		<p>Invertitore automatico (per ref. / Kód / for Nr.: 170) Automatický přepínač <i>Diverter</i></p>  <table border="1"> <tr><td>Cr</td><td>91.24.170.02</td><td></td></tr> <tr><td>Lv</td><td>91.24.170.15.1</td><td></td></tr> <tr><td>Ac</td><td>91.24.170.15.3</td><td></td></tr> </table>	Cr	91.24.170.02		Lv	91.24.170.15.1		Ac	91.24.170.15.3				
Cr	91.34.062.200																																	
Cr	91.34.062.10.0																																	
Lv	91.34.062.15.1																																	
Ac	91.34.062.15.3																																	
Cr	91.34.162.10.0																																	
Lv	91.34.162.15.1																																	
Ac	91.34.162.15.3																																	
Cr	91.24.170.02																																	
Lv	91.24.170.15.1																																	
Ac	91.24.170.15.3																																	
<p>Crocetta con indicatore Otočný ovladač s označením teploty <i>Handle with index</i></p>  <table border="1"> <tr><td>Cr</td><td>F</td><td>91.34.061.10.0</td><td></td></tr> <tr><td>Lv</td><td>F</td><td>91.34.061.15.1</td><td></td></tr> <tr><td>Ac</td><td>F</td><td>91.34.061.15.3</td><td></td></tr> </table> <table border="1"> <tr><td>Cr</td><td>C</td><td>91.34.061.20.0</td><td></td></tr> <tr><td>Lv</td><td>C</td><td>91.34.061.25.1</td><td></td></tr> <tr><td>Ac</td><td>C</td><td>91.34.061.25.3</td><td></td></tr> </table>	Cr	F	91.34.061.10.0		Lv	F	91.34.061.15.1		Ac	F	91.34.061.15.3		Cr	C	91.34.061.20.0		Lv	C	91.34.061.25.1		Ac	C	91.34.061.25.3		<p>Tubo lavello (per ref. / Kód / for Nr.: 24.341, 24.342, 24.334) Stojánková výtoková hubice <i>Spout</i></p>  <table border="1"> <tr><td>Cr</td><td>91.24.341</td><td></td></tr> <tr><td>Lv</td><td>91.24.341.05.1</td><td></td></tr> <tr><td>Ac</td><td>91.24.341.05.3</td><td></td></tr> </table>	Cr	91.24.341		Lv	91.24.341.05.1		Ac	91.24.341.05.3	
Cr	F	91.34.061.10.0																																
Lv	F	91.34.061.15.1																																
Ac	F	91.34.061.15.3																																
Cr	C	91.34.061.20.0																																
Lv	C	91.34.061.25.1																																
Ac	C	91.34.061.25.3																																
Cr	91.24.341																																	
Lv	91.24.341.05.1																																	
Ac	91.24.341.05.3																																	
<p>Indice Zátka s označením teploty <i>Index</i></p>  <table border="1"> <tr><td></td><td></td><td>91.34.060.01</td><td></td></tr> <tr><td></td><td></td><td>91.34.060.02</td><td></td></tr> </table>			91.34.060.01				91.34.060.02		<p>Tubo lavabo Výtoková hubice umyvadlové baterie <i>Washbasin spout</i></p>  <table border="1"> <tr><td>Cr</td><td>91.24.106</td><td></td></tr> <tr><td>Lv</td><td>91.24.106.05.1</td><td></td></tr> <tr><td>Ac</td><td>91.24.106.05.3</td><td></td></tr> </table>	Cr	91.24.106		Lv	91.24.106.05.1		Ac	91.24.106.05.3																	
		91.34.060.01																																
		91.34.060.02																																
Cr	91.24.106																																	
Lv	91.24.106.05.1																																	
Ac	91.24.106.05.3																																	
<p>Cappuccio montatura (per ref. / Kód / for Nr.: 24.342) Kryt hlavy <i>Cartridge stem lid</i></p>  <table border="1"> <tr><td>Cr</td><td>91.24.103</td><td></td></tr> <tr><td>Lv</td><td>91.24.103.05.1</td><td></td></tr> <tr><td>Ac</td><td>91.24.103.05.3</td><td></td></tr> </table>	Cr	91.24.103		Lv	91.24.103.05.1		Ac	91.24.103.05.3		<p>Tubo bidé Výtoková hubice bidetové baterie <i>Bidet spout</i></p>  <table border="1"> <tr><td>Cr</td><td>91.24.124</td><td></td></tr> <tr><td>Lv</td><td>91.24.124.05.1</td><td></td></tr> </table>	Cr	91.24.124		Lv	91.24.124.05.1																			
Cr	91.24.103																																	
Lv	91.24.103.05.1																																	
Ac	91.24.103.05.3																																	
Cr	91.24.124																																	
Lv	91.24.124.05.1																																	
<p>Cappuccio (per ref. / Kód / for Nr.: 24.341) Kryt <i>Lid</i></p>  <table border="1"> <tr><td>Cr</td><td>91.24.341.02</td><td></td></tr> <tr><td>Lv</td><td>91.24.341.25.1</td><td></td></tr> <tr><td>Ac</td><td>91.24.341.25.3</td><td></td></tr> </table>	Cr	91.24.341.02		Lv	91.24.341.25.1		Ac	91.24.341.25.3		<p>Aeratore Perlátor <i>Aerator</i></p>  <table border="1"> <tr><td>Cr</td><td>91.24.672</td><td></td></tr> <tr><td>Lv</td><td>91.24.672.05.1</td><td></td></tr> <tr><td>Ac</td><td>91.24.672.05.3</td><td></td></tr> </table>	Cr	91.24.672		Lv	91.24.672.05.1		Ac	91.24.672.05.3																
Cr	91.24.341.02																																	
Lv	91.24.341.25.1																																	
Ac	91.24.341.25.3																																	
Cr	91.24.672																																	
Lv	91.24.672.05.1																																	
Ac	91.24.672.05.3																																	
<p>Base lavabo (per ref. / Kód / for Nr.: 29.103, 29.120) Ozdobný kroužek pod umyvadlovou baterií <i>Mixer base</i></p>  <table border="1"> <tr><td>Cr</td><td>91.24.103.02</td><td></td></tr> <tr><td>Lv</td><td>91.24.103.02.51</td><td></td></tr> <tr><td>Ac</td><td>91.24.103.02.53</td><td></td></tr> </table>	Cr	91.24.103.02		Lv	91.24.103.02.51		Ac	91.24.103.02.53		<p>Scarico automatico (per ref. / Kód / for Nr.: 29.103, 29.120) 1,1/4" Automatický odtok <i>Pup-up waste</i></p>  <table border="1"> <tr><td>Cr</td><td>91.24.840.10</td><td></td></tr> <tr><td>Lv</td><td>91.24.840.15.1</td><td></td></tr> <tr><td>Ac</td><td>91.24.840.15.3</td><td></td></tr> </table>	Cr	91.24.840.10		Lv	91.24.840.15.1		Ac	91.24.840.15.3																
Cr	91.24.103.02																																	
Lv	91.24.103.02.51																																	
Ac	91.24.103.02.53																																	
Cr	91.24.840.10																																	
Lv	91.24.840.15.1																																	
Ac	91.24.840.15.3																																	
<p>Rosone Rozeta <i>Cover plate</i></p>  <table border="1"> <tr><td>Cr</td><td>91.24.170</td><td></td></tr> <tr><td>Lv</td><td>91.24.170.05.1</td><td></td></tr> <tr><td>Ac</td><td>91.24.170.05.3</td><td></td></tr> </table>	Cr	91.24.170		Lv	91.24.170.05.1		Ac	91.24.170.05.3		<p>Set asta e pulsante (per ref. / Kód / for Nr.: 29.103, 29.120) Sada přepínače s vedením a úchytem <i>Button and rod set</i></p>  <table border="1"> <tr><td>Cr</td><td>91.24.840</td><td></td></tr> <tr><td>Lv</td><td>91.24.840.05.1</td><td></td></tr> <tr><td>Ac</td><td>91.24.840.05.3</td><td></td></tr> </table>	Cr	91.24.840		Lv	91.24.840.05.1		Ac	91.24.840.05.3																
Cr	91.24.170																																	
Lv	91.24.170.05.1																																	
Ac	91.24.170.05.3																																	
Cr	91.24.840																																	
Lv	91.24.840.05.1																																	
Ac	91.24.840.05.3																																	
<p>Rotula (per ref. / Kód / for Nr.: 29.124) 22x100 Bidetové klouby <i>Ball-and-socket joint bidet mixer</i></p>  <table border="1"> <tr><td>Cr</td><td>91.24.672.20</td><td></td></tr> <tr><td>Lv</td><td>91.24.672.25.1</td><td></td></tr> <tr><td>Ac</td><td>91.24.672.25.2</td><td></td></tr> </table>	Cr	91.24.672.20		Lv	91.24.672.25.1		Ac	91.24.672.25.2		<p>Scarico automatico (per ref. / Kód / for Nr.: 29.105) Automatický odtok <i>Pup-up waste</i></p>  <table border="1"> <tr><td>Cr</td><td>91.29.105.10.0</td><td></td></tr> <tr><td>Lv</td><td>91.29.105.15.1</td><td></td></tr> <tr><td>Ac</td><td>91.29.105.15.3</td><td></td></tr> </table>	Cr	91.29.105.10.0		Lv	91.29.105.15.1		Ac	91.29.105.15.3																
Cr	91.24.672.20																																	
Lv	91.24.672.25.1																																	
Ac	91.24.672.25.2																																	
Cr	91.29.105.10.0																																	
Lv	91.29.105.15.1																																	
Ac	91.29.105.15.3																																	
<p>Rotula (per ref. / Kód / for Nr.: 29.120) 22x100 Bidetové klouby <i>Ball-and-socket joint bidet mixer</i></p>  <table border="1"> <tr><td>Cr</td><td>91.24.277</td><td></td></tr> <tr><td>Lv</td><td>91.24.277.05.1</td><td></td></tr> <tr><td>Ac</td><td>91.24.277.05.3</td><td></td></tr> </table>	Cr	91.24.277		Lv	91.24.277.05.1		Ac	91.24.277.05.3		<p>Set asta e pulsante (per ref. / Kód / for Nr.: 29.105) Sada přepínače s vedením a úchytem <i>Button and rod set</i></p>  <table border="1"> <tr><td>Cr</td><td>91.29.105</td><td></td></tr> <tr><td>Lv</td><td>91.29.105.05.1</td><td></td></tr> <tr><td>Ac</td><td>91.29.105.05.3</td><td></td></tr> </table>	Cr	91.29.105		Lv	91.29.105.05.1		Ac	91.29.105.05.3																
Cr	91.24.277																																	
Lv	91.24.277.05.1																																	
Ac	91.24.277.05.3																																	
Cr	91.29.105																																	
Lv	91.29.105.05.1																																	
Ac	91.29.105.05.3																																	
	<p>Scarico automatico (per ref. / Kód / for Nr.: 29.104, 29.124) Automatický odtok <i>Pup-up waste</i></p>  <table border="1"> <tr><td>Cr</td><td>91.29.104.10.0</td><td></td></tr> <tr><td>Lv</td><td>91.29.104.15.1</td><td></td></tr> <tr><td>Ac</td><td>91.29.104.15.3</td><td></td></tr> </table>	Cr	91.29.104.10.0		Lv	91.29.104.15.1		Ac	91.29.104.15.3																									
Cr	91.29.104.10.0																																	
Lv	91.29.104.15.1																																	
Ac	91.29.104.15.3																																	
	<p>Set asta e pulsante (per ref. / Kód / for Nr.: 29.104, 29.124) Sada přepínače s vedením a úchytem <i>Button and rod set</i></p>  <table border="1"> <tr><td>Cr</td><td>91.29.104</td><td></td></tr> <tr><td>Lv</td><td>91.29.104.05.1</td><td></td></tr> <tr><td>Ac</td><td>91.29.104.05.3</td><td></td></tr> </table>	Cr	91.29.104		Lv	91.29.104.05.1		Ac	91.29.104.05.3																									
Cr	91.29.104																																	
Lv	91.29.104.05.1																																	
Ac	91.29.104.05.3																																	
	<p>Vitone calda Hlava ke standardním bateriím teplá <i>Cartridge stem hot</i></p>  <table border="1"> <tr><td></td><td></td><td>91.34.272.10</td><td></td></tr> </table>			91.34.272.10																														
		91.34.272.10																																

Cr = Cromo/Chrom/Chrome Lv = Ottone antico/stará mosaz/Old brass Ac = Acciaio/Kartáčovaná ocel/Steel

F = Fredda/Studená/Cold C = Calda/Teplá/Hot

RETRO-TRES

Ricambi / Náhradní díly / Spare parts

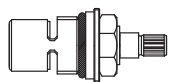

Vitone fredda
Hlava ke standardním
bateriím studená
Cartridge stem cold

91.34.272.20

Set fissaggio

Montážní sada
Locking set

(per ref. / Kód / for Nr.: 103, 120)

91.29.103.10

(per ref. / Kód / for Nr.: 341)

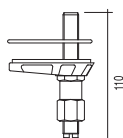

91.24.341.10

(per ref. / Kód / for Nr.: 104, 124, 342)

91.24.342.10

(per ref. / Kód / for Nr.: 334)

91.24.334.10

 BIMAX-TRES

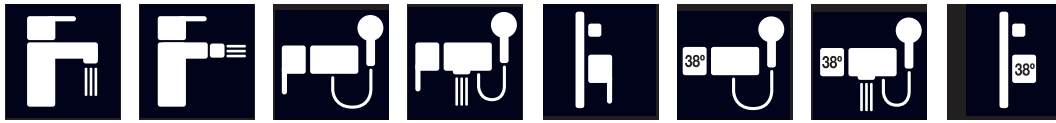

1.63.278



1.63.103



063.172.01

□ BIMAX-TRES

BIMAX-TRES

Lavabi / Umyvadla / Basins

Ref. / Kód / Nr.:

Monoblocco lavabo
Umyvadlová baterie
Single hole wash-basin mixer

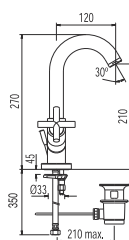

Cr 1.63.103



Cr 1.68.103



Accumulatore lavabo
Umyvadlová baterie
Wash-basin mixer

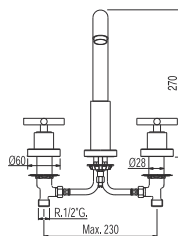

Cr 1.68.105



Accumulatore lavabo a muro
cana lunga 250 mm.
Nastěnná umyvadlová baterie
Dlouhá výtoková hubice 250 mm.
Wash-basin mixer
Long spout 250 mm

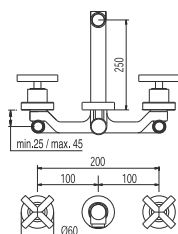

Cr 1.63.151



Monocomando lavabo
ecologico
Cartuccia progressiva
Umyvadlová baterie
Progressivní regulátor
Single hole wash-basin mixer
Progressive cartridge

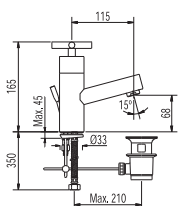

91.34.588 Cr 1.63.103.10





91.34.588 Cr 1.68.103.10







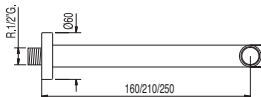

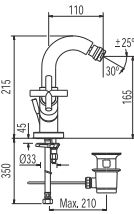

Cr = Cromo/Chrom/Chrome

Raccomandabile installare la valvola SIMPLE RAPID (non inclusa)
Doporučuje se použít ventil Simple Rapid (není v ceně)
Ideal assembly with SIMPLE RAPID valve (This is not included)

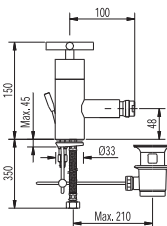

BIMAX-TRES

		Ref. / Kód / Nr.:	
	Canna parete Stěnová trubice Wall spout		(16 cm.) Cr 1.61.170.02
			(21 cm.) Cr 061.172.02
			(25 cm.) Cr 1.61.171.02

Bidet / Bidety / Bidets



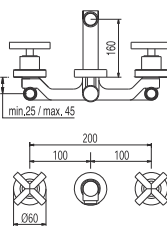







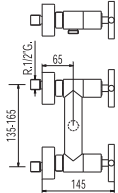

		Ref. / Kód / Nr.:	
	Monoblocco bidet Bidetová baterie Single hole bidet mixer		 Cr 1.63.120
			 Cr 1.68.120
	Monocomando bidet Cartuccia progressiva Bidetová baterie Progressivní regulátor Single hole bidet mixer Progressive cartridge		 91.34.588 Cr 1.63.120.10
			 91.34.588 Cr 1.68.120.10



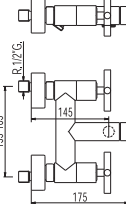

Doppi comandi bagno / Vanové baterie s dvoupákovým mechanismem / Bathroom dual control taps

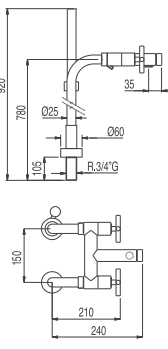
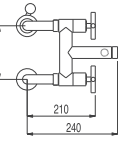
		Ref. / Kód / Nr.:	
	Accumulatore lavabo a muro canna corta Nastěnná umyvadlová baterie krátká výtoková hubice 160 mm. Wash-basin mixer Short spout 160 mm		 Cr 1.63.152

Cr = Cromo/Chrom/Chrome

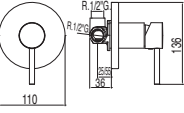
 Raccomandabile installare la valvola SIMPLE RAPID (non inclusa)
 Doporučuje se použít ventil Simple Rapid (není v ceně)
 Ideal assembly with SIMPLE RAPID valve (This is not included)

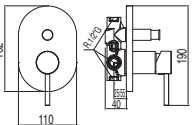
		Ref. / Kód / Nr.:			
	<p>Gruppo doccia Doccia anticalcare (034.116.01). Flessibile satin (91.34.609.15).</p> <p>Sprchová baterie Ruční sprchy se systémem proti vzniku vodního kamene (034.116.01), hadice satin (91.34.609.15).</p> <p><i>Shower mixer</i> <i>Antilime hand shower (034.116.01) and satin hose (91.34.609.15).</i></p> 	   <p>OTTONE MOSAZ BRASS</p> <table border="1"> <tr> <td>Cr</td> <td>1.63.868</td> <td></td> </tr> </table>	Cr	1.63.868	
Cr	1.63.868				
	<p>Gruppo vasca Doccia anticalcare (034.116.01). Flessibile satin (91.34.609).</p> <p>Vanová baterie Ruční sprchy se systémem proti vzniku vodního kamene (034.116.01), hadice satin (91.34.609).</p> <p><i>Bath and shower mixer</i> <i>Antilime hand shower (034.116.01) and satin hose (91.34.609).</i></p>	   <p>OTTONE MOSAZ BRASS</p> <table border="1"> <tr> <td>Cr</td> <td>1.63.874</td> <td></td> </tr> </table>	Cr	1.63.874	
Cr	1.63.874				
	<p>Gruppo vasca con presa a pavimento Doccia anticalcare (034.116.01). Flessibile satin (91.34.609).</p> <p>Vanová baterie s podlahovými přípojkami Ruční sprchy se systémem proti vzniku vodního kamene (034.116.01), hadice satin (91.34.609).</p> <p><i>Bath & shower mixer with connections to the floor</i> <i>Antilime hand shower (034.116.01) and satin hose (91.34.609).</i></p>	   <p>OTTONE MOSAZ BRASS</p> <table border="1"> <tr> <td>Cr</td> <td>1.63.194</td> <td></td> </tr> </table>	Cr	1.63.194	
Cr	1.63.194				

Ad incasso / Vestavěné / Built-in		Ref. / Kód / Nr.:			
	<p>Monocomando ad incasso doccia</p> <p>Podomítková sprchová baterie <i>Single lever concealed shower mixer</i></p>	  <p>91.34.592</p> <table border="1"> <tr> <td>Cr</td> <td>1.62.177.05</td> <td></td> </tr> </table>	Cr	1.62.177.05	
Cr	1.62.177.05				
	<p>Monocomando incasso bagno doccia con deviatore</p> <p>Podomítková vanová baterie s ruční sprchou <i>Single lever concealed bath and shower mixer</i></p>	  <p>91.34.592</p> <table border="1"> <tr> <td>Cr</td> <td>1.62.180.05</td> <td></td> </tr> </table>	Cr	1.62.180.05	
Cr	1.62.180.05				

Cr = Cromo/Chrom/Chrome

BIMAX-TRES

Ref. / Kód / Nr.:



Monocomando ad incasso doccia

Podomítková sprchová baterie
Single lever concealed shower mixer

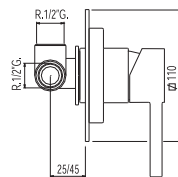

91.34.288

Cr

1.62.177



Monocomando incasso bagno doccia con deviatore

Podomítková vanová baterie s
ruční sprchou
Single lever concealed bath and
shower mixer

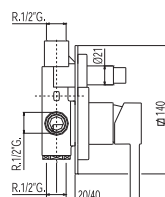

91.34.288

Cr

1.62.180

Gruppi ad incasso / Vestavěné soupravy / Built-in sets

Ref. / Kód / Nr.:



Kit doccia ad incasso BIMAX

Con chiusura e regolazione di portata. Doccia fissa da Ø 300 mm. (1.34.137.30).
Ottone.

Podomítkový set se sprchou BIMAX

S uzávěrem a regulací průtoku. Hlavová sprcha Ø 300 mm. (1.34.137.30). Mosaz.

Concealed shower set BIMAX

with water shut off and flow control. Fixed shower head Ø 300 mm. (1.34.137.30). Brass.

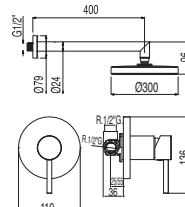

OTTONE
MOSAZ
BRASS



91.34.592

Cr

1.62.377.05



Kit doccia ad incasso BIMAX

Con chiusura e regolazione di portata. Doccia fissa da Ø 300 mm. (1.34.137.30).
Ottone. Supporto per doccia (91.34.182). Doccia anticalcare (034.116.01).
Flessibile satin (91.34.609.15).

Podomítkový set se sprchou BIMAX

S uzávěrem a regulací průtoku. Hlavová sprcha Ø 300 mm. (1.34.137.30). Mosaz. Pevný
držák s vodní přípojkou pro hadici (91.34.182). Ruční sprchy se systémem proti vzniku
vodního kamene (034.116.01), hadice satin (91.34.609.15).

Concealed shower set BIMAX

with water shut off and flow control. Fixed shower
head Ø 300 mm. (1.34.137.30). Brass. Elbow wall
(91.34.182). Antilime hand shower (034.116.01) and
satin hose (91.34.609.15).

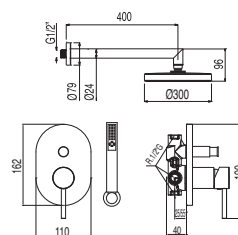

OTTONE
MOSAZ
BRASS



OTTONE
MOSAZ
BRASS



91.34.592

Cr

1.62.880.05

Cr = Cromo/Chrom/Chrome

Ref. / Kód / Nr.:



N

Kit doccia ad incasso BIMAX

Con chiusura e regolazione di portata. Doccia fissa da Ø 300 mm. Ottone (1.34.137.30). Asta antiscivolo lunga 550 mm. (1.34.618). Presa a parete (1.34.758). Doccia anticalcarea. (034.116.01) e flessibile satin (91.34.609.15).

Podomítkový sprchový set BIMAX

S uzavěrem a regulací průtoku. Hlavová sprcha Ø 300 mm. Mosaz (1.34.137.30). Posuvná tyč. Délka 550 mm. (1.34.618). Pevný držák s vodní přípojkou pro hadici (1.34.758). Sprchová koncovka se systémem proti tvorbě vodního kamene. (034.116.01) a hadicí satin (91.34.609.15).

Concealed shower kit BIMAX with water shut off and flow control. Fixed shower head Ø 300 mm. Brass. (1.34.137.30). Bar-shower antilime. long. 550 mm. (1.34.618). Elbow wall (1.34.758). Antilime hand shower (034.116.01) and satin hose (91.34.609.15).

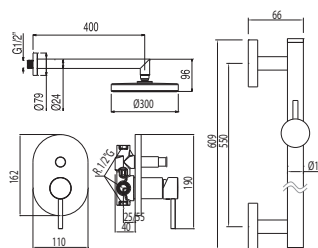

OTTONE
MOSAZ
BRASS



OTTONE
MOSAZ
BRASS



91.34.592

Cr

063.980.06

Bordovasca / Vany s prodlouženým pultem / Deck-mounted bathtubs

Ref. / Kód / Nr.:

Batteria bordo vasca

Doccia anticalcarea (034.116.01)

Stojánková vanová baterie víceotvorová

Ruční sprchy se systémem proti vzniku vodního kamene (034.116.01)

Bath-shower single lever tap for bracket shelf

Antilime hand shower (034.116.01)

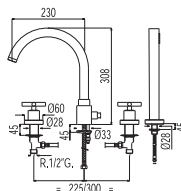

OTTONE
MOSAZ
BRASS



°C
3 bar
17 l/m



Cr

1.63.145



Kit bordo vasca

Facile montaggio superiore. Senza registro

Montážní sada k 3-otvorové baterii s odtokem zbytků vody. Snadná montáž/demontáž seshora. Není nutné montovat dodatečně revizní prvky u vany

Bath-shower kit cistern

easy upper assembly, without installation

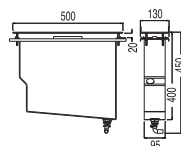

Brevettato®
Patentovaný®
Patented®

Cr

1.34.345



Valvola vasca con presa drenaggio

Vanový sifón typu click-clack s přípojkou k odtokovému systému 3-otvorové baterie

Bath valve with drainage point

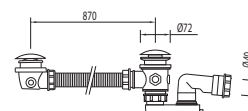

Cr

1.34.445

BIMAX-TRES

Termostatiche / Termostatické / Thermostatically-controlled

Ref. / Kód / Nr.:

N



Doccia BIMAX termostatica
(Doccia anticalcare (034.116.01).
Flessibile satin (91.34.609.15)).

Termostatická sprchová baterie
BIMAX
(Ruční sprchy se systémem proti
vzniku vodního kamene (034.116.01),
hadice satin (91.34.609.15)).

*Wall thermostatic shower mixer
BIMAX*
(Antilime hand shower (034.116.01)
and satin hose (91.34.609.15)).



TRES TOUCH-COOL

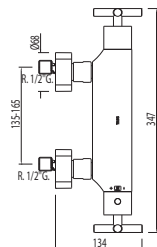

Cr 063.162.01



OTTONE
MOSAZ
BRASS

Cr 063.162.09

N



Vasca-Doccia BIMAX termostatica
Con bocca a cascata. (Doccia anticalcare
(034.116.01). Flessibile satin (91.34.609)).

Termostatická vanová a
sprchová baterie BIMAX
S kaskádou. (Ruční sprchy se systémem
proti vzniku vodního kamene
(034.116.01), hadice satin (91.34.609)).

*Wall thermostatic shower mixer
BIMAX*
With cascade. (Antilime hand shower
(034.116.01) and satin hose (91.34.609)).



TRES TOUCH-COOL

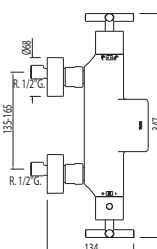

Cr 063.172.01



OTTONE
MOSAZ
BRASS

Cr 063.172.09



**2 prese da terra per vasca
con supporto girevole**

2 podlahové přípojky k vanové
baterii

s otočnou úchytkou

2-outlet bathtub base

With revolving stand

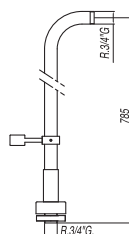

Cr 1.61.194

Gruppi termostatici / Termostatické soupravy / Thermostatically-controlled sets

Ref. / Kód / Nr.:



N

Set doccia BIMAX termostatica

Doccia fissa da Ø 300 mm. (1.34.137.30). Ottone. Doccia anticalcare (034.116.01). Flessibile satin (91.34.609.15). Invertitore integrato nel regolatore di portata (si veda pagina 576)

Termostatický sprchový set BIMAX

Hlavová sprcha Ø 300 mm. (1.34.137.30). Mosaz. Ruční sprchy se systémem proti vzniku vodního kamene (034.116.01), hadice satin (91.34.609.15). Přepínač proudů integrovaný s regulátorem tlaku (viz ste 576)

Wall thermostatic shower mixer BIMAX

Fixed shower head Ø 300 mm. (1.34.137.30). Brass. Antilime hand shower (034.116.01) and satin hose (91.34.609.15). Diverter integrated in the flow control (see page 576)

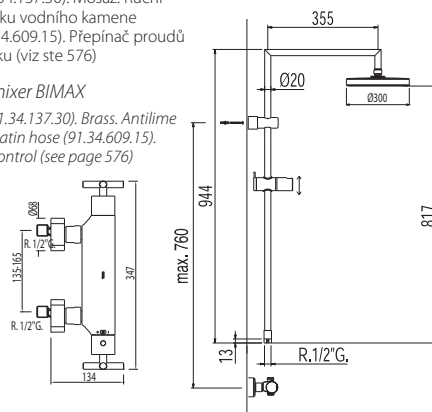

TRES TOUCH-COOL®



OTTONE
MOSAZ
BRASS



OTTONE
MOSAZ
BRASS

Cr

063.393.01



N

Set doccia BIMAX termostatica

Doccia fissa da Ø 300 mm. (1.34.137.30). Ottone. Doccia anticalcare (034.116.01). Flessibile satin (91.34.609.15). Asta telescopica. Invertitore integrato nel regolatore di portata (si veda pagina 576)

Termostatický sprchový set BIMAX

Hlavová sprcha Ø 300 mm. (1.34.137.30). Mosaz. Ruční sprchy se systémem proti vzniku vodního kamene (034.116.01), hadice satin (91.34.609.15). Tyč s teleskopickou regulací výšky. Přepínač proudů integrovaný s regulátorem tlaku (viz str. 576)

Wall thermostatic shower mixer BIMAX

Fixed shower head Ø 300 mm. (1.34.137.30). Brass. Antilime hand shower (034.116.01) and satin hose (91.34.609.15). Telescopic bar. Diverter integrated in the flow control (see page 576)

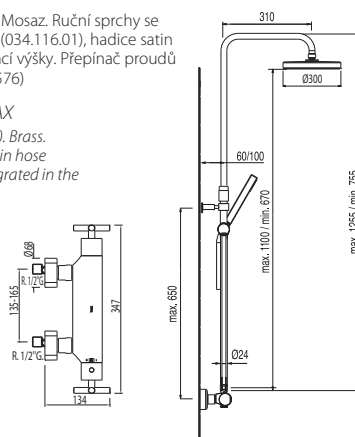

TRES TOUCH-COOL®



OTTONE
MOSAZ
BRASS



OTTONE
MOSAZ
BRASS

Cr

063.211.01



Set doccia BIMAX termostatica

Doccia fissa da Ø 300 mm. (1.34.137.30). Ottone. Doccia anticalcare (034.116.01). Flessibile satin (91.34.609.15). Asta telescopica. Invertitore integrato nel regolatore di portata (si veda pagina 576)

Termostatický sprchový set BIMAX

Hlavová sprcha Ø 300 mm. (1.34.137.30). Mosaz. Ruční sprchy se systémem proti vzniku vodního kamene (034.116.01), hadice satin (91.34.609.15). Tyč s teleskopickou regulací výšky. Přepínač proudů integrovaný s regulátorem tlaku (viz str. 576)

Wall thermostatic shower mixer BIMAX

Fixed shower head Ø 300 mm. (1.34.137.30). Brass. Antilime hand shower (034.116.01) and satin hose (91.34.609.15). Telescopic bar. Diverter integrated in the flow control (see page 576)

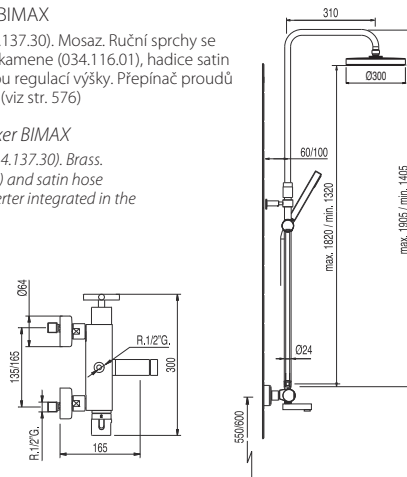

TRES TOUCH-COOL®



OTTONE
MOSAZ
BRASS



OTTONE
MOSAZ
BRASS

Cr

1.90.311

Cr = Cromo/Chrom/Chrome



kit termostatico doccia ad incasso BIMAX

Con chiusura e regolazione di portata. (2 vie) Doccia fissa da Ø 300 mm. (1.34.137.30). Ottone. Supporto per doccia (91.34.182). Doccia anticalcarea (034.116.01). Flessibile satin (91.34.609.15).

Termostatický podomítkový sprchový set BIMAX

S uzávěrem a regulací průtoku. (Dvoucestný) Hlavová sprcha Ø 300 mm. (1.34.137.30). Mosaz. Pevný držák s vodní přípojkou pro hadici (91.34.182). Ruční sprchy se systémem proti vzniku vodního kamene (034.116.01), hadice satin (91.34.609.15).

Concealed thermostatic shower kit BIMAX

with water shut off and flow control. (2 ways) Fixed shower head Ø 300 mm. (1.34.137.30). Brass. Elbow wall (91.34.182). Antilime hand shower (034.116.01) and satin hose (91.34.609.15).

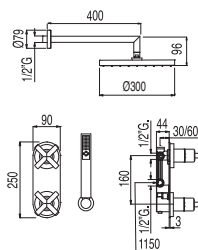

OTTONE
MOSAZ
BRASS



OTTONE
MOSAZ
BRASS



Cr 1.63.275

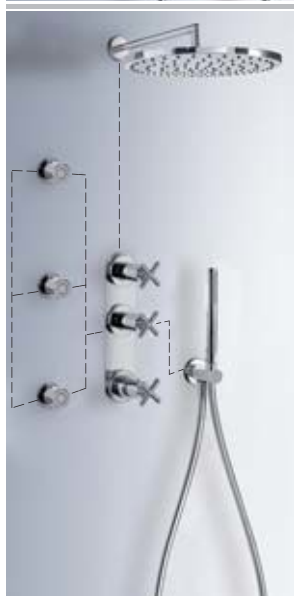

kit termostatico doccia ad incasso BIMAX

Con chiusura e regolazione di portata. (3 vie) Doccia fissa da Ø 300 mm. (1.34.137.30). Ottone. Supporto per doccia (91.34.182). 3 jets anticalcarea (2 funzioni) (91.34.415). Doccia anticalcarea. (034.116.01). Flessibile satin (91.34.609.15).

Termostatický podomítkový sprchový set BIMAX

S uzávěrem a regulací průtoku. (Trojcestný) Hlavová sprcha Ø 300 mm. (1.34.137.30). Mosaz. Pevný držák s vodní přípojkou pro hadic. (91.34.182). Tři postranní trysky se systémem proti vzniku vodního kamene (2-proudové) (91.34.415). Sprchová koncovka se systémem proti tvorbě vodního kamene. (034.116.01). Hadice satin (91.34.609.15).

Concealed thermostatic shower kit BIMAX

with water shut off and flow control. (3 ways) Fixed shower head Ø 300 mm. (1.34.137.30). Brass. Elbow wall. (91.34.182). 3 antilime jets, 2 operations (91.34.415). Antilime hand shower. (034.116.01). Satin hose (91.34.609.15).

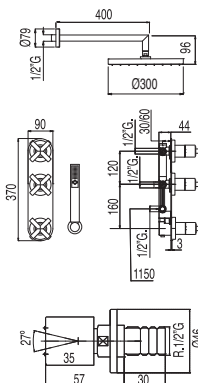

OTTONE
MOSAZ
BRASS



OTTONE
MOSAZ
BRASS



Cr 1.63.278

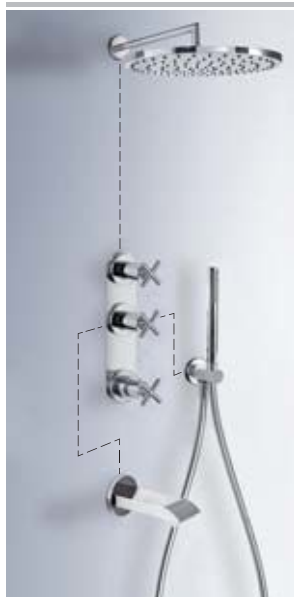

Kit termostatico vasca ad incasso BIMAX

Con chiusura e regolazione di portata. (3 vie) Doccia fissa da Ø 300 mm. (1.34.137.30). Ottone. Supporto per doccia (91.34.182). Con bocca a cascata (1.87.181.50). Doccia anticalcarea. (034.116.01). Flessibile satin (91.34.609.15).

Termostatický podomítkový vanový set s ruční sprchou BIMAX

S uzávěrem a regulací průtoku. (Trojcestný) Hlavová sprcha Ø 300 mm. (1.34.137.30). Mosaz. Pevný držák s vodní přípojkou pro hadici (91.34.182). Přivalovým přítokem vanový set (1.87.181.50). Sprchová koncovka se systémem proti tvorbě vodního kamene. (034.116.01). Hadice satin (91.34.609.15).

Concealed thermostatic bath kit BIMAX

with water shut off and flow control. (3 ways) Fixed shower head Ø 300 mm. (1.34.137.30). Brass. Elbow wall (91.34.182). Cascade cast spout (1.87.181.50). Antilime hand shower. (034.116.01). Satin hose (91.34.609.15).

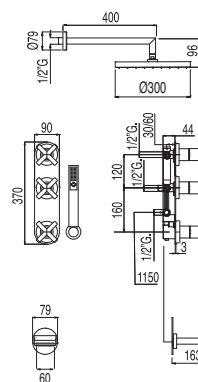

OTTONE
MOSAZ
BRASS



OTTONE
MOSAZ
BRASS



Cr 1.63.144

Ref. / Kód / Nr.:

Batteria vasca termostatica BIMAX

Con bocca a cascata. Supporto per doccia (91.34.182). Doccia anticalcare. (034.116.01). Flessibile satin (91.34.609).

Termostatická podomítková vanová baterie se sprchou BIMAX

S přívalovým vtokem. Pevný držák s vodní přípojkou pro hadici (91.34.182). Sprchová koncovka se systémem proti tvorbě vodního kamene. (034.116.01). Hadice satin (91.34.609).

Thermostatic bath BIMAX

with cascade cast spout. Elbow wall (91.34.182). Antilime hand shower. (034.116.01). Satin hose (91.34.609).



TRES BLOCK-SYSTEM

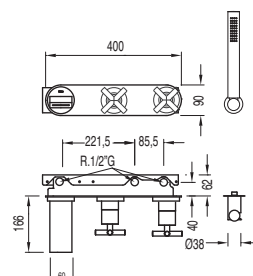

OTTONE
MOSAZ
BRASS

Cr

1.63.192

Rubinetti di arresto / Průchozí ventily / Shutoff valves

Ref. / Kód / Nr.:

N



Rubinetto di arresto filettato 1/2"

Ventil se závitem 1/2"

1/2" threaded-ends gate-valve

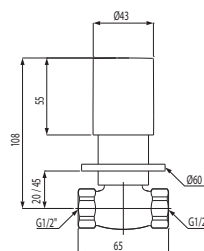

Cr

061.155.01

N



Rubinetto di arresto filettato 3/4"

Ventil se závitem 3/4"

3/4" threaded-ends gate-valve

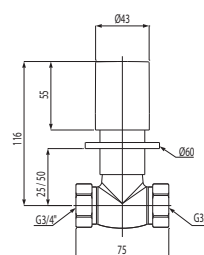



Cr

061.511.01

BIMAX-TRES

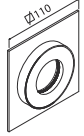
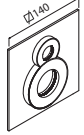
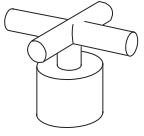
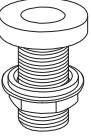
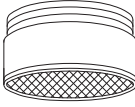
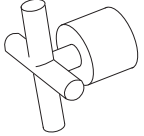
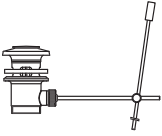
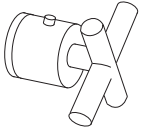
Ricambi / Náhradní díly / Spare parts

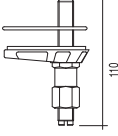
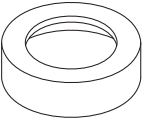
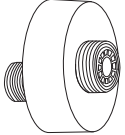
	Manopola Úchyt Lever	(per ref. / Kód / for Nr.: 63.177, 63.180)		Base + rosone Sada rozet Base + cover plate	(per ref. / Kód / for Nr.: 63.177)
		Cr 91.34.080			Cr 91.62.177.10
	Crocetta completa Otočný ovladač Handle	(per ref. / Kód / for Nr.: 63.151, 63.152, 63.155, 63.511)		Base + rosone Sada rozet Base + cover plate	(per ref. / Kód / for Nr.: 63.180)
		Cr 91.63.003			Cr 91.62.180.10
				Supporto doccia Držák sprchy Cover plate and fixing kit	(per ref. / Kód / for Nr.: 63.145)
		Cr 91.34.003			Cr 91.62.145.40
		(per ref. / Kód / for Nr.: 68.103.10, 63.103.10, 68.120.10, 63.120.10)		Aeratore Perlátor Aerator	(per ref. / Kód / for Nr.: 63.103, 63.333, 68.105, 63.145)
		Cr 91.34.003.10			Cr 92.63.774
	Crocetta termostatica completa Termostatický otočný ovladač kompletní Handle	(per ref. / Kód / for Nr.: 63.182, 90.183, 90.193, 90.868, 90.874, 63.195, 63.395, 63.198, 63.798, 90.211, 90.393, 90.583)		Scarico automatico Automatický odtok Pop-up waste	1,1/4"
		Cr 91.94.183			Cr 91.34.275.10
	Crocetta completa Otočný ovladač Handle	(per ref. / Kód / for Nr.: 63.164, 63.174, 63.192, 63.250, 63.251, 63.252, 63.253)		Set asta e pulsante Sada přepínače s vedením a úchytem Button and rod set	
		Cr 91.34.003.20			Cr 91.34.275
	Cartuccia termostatica + volano Termostatická vložka s otočným ovládačem Thermostatic cartridge stem + Handle	(per ref. / Kód / for Nr.: 90.183, 90.193, 90.868, 90.874, 90.393, 90.583)		Set fissaggio Montážní sada Sink mixer locking set	(per ref. / Kód / for Nr.: 63.103.10, 63.120.10, 68.103.10, 68.120.10)
		Cr 91.94.161.01			96.61.103.01
	Base lavabo Ozdobný kroužek pod umyvadlovou baterii Mixer base				
		Cr 91.63.103.02			
	Rosone con eccentrico Krycí rozeta s excentrickou spojkou Cover plate + excentric union				
		Cr 91.61.170.19			

Cr = Cromo/Chrom/Chrome



1.92.606.03

TRESTRONIC





 TRESTRONIC

1.61.445

TRESTRONIC

Lavabi / Umyvadla / Basins

Ref. / Kód / Nr.:



Lavabo elettronico
Baterie s elektronickým řízením
Electronic wash-basin

Un'acqua
Pro studenou vodu (nebo vstupně smíšenou)
Only cold water

Miscelatore
Se směřovačem
Cold and warm water



Cr	1.92.606.03	
Cr	1.92.906.03	



Bagno / Koupelna / Bath

Ref. / Kód / Nr.:



Gruppo lavabo elettronico acqua calda e fredda, solo un'acqua
Elektronicky řízená výtoková hubice
Pro studenou vodu (nebo vstupně smíšenou)
Electronic wash-basin Only cold water

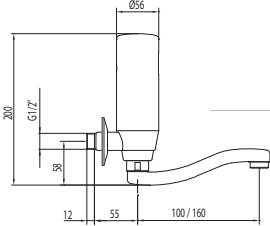

		(10 cm.)
Cr	092.170.01	
		(16 cm.)
Cr	092.171.01	



Rubinetto scarico elettronico per urinatorio con due tubi adattabili a urinatoio
Nadomítkový elektronický ventil k pisoáru
Obsahuje dva druhy připojovacích trubek
Electronic view urinary tap with two adaptable tubs to urinary

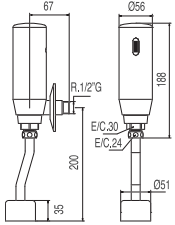

Cr	1.12.206	
----	----------	--

Cr = Cromo/Chrom/Chrome

TRESTRONIC

Ref. / Kód / Nr.:



Rubinetto scarico elettronico per urinatorio

Nadomítkový elektronický ventil k pisoáru

Electronic concealed urinary tap

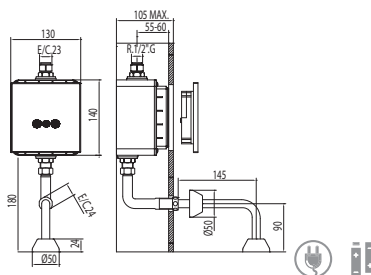

Cr

012.207.01



Rubinetto scarico elettronico per urinatorio

Nadomítkový elektronický ventil k pisoáru

Electronic concealed urinary tap

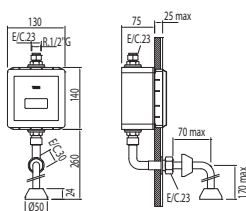

Cr

1.12.207



Flussometro elettronico incassato per WC

Zabudovaný elektronický průtokoměr pro WC

Built-in electronic flow meter for WC

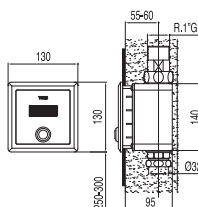

Cr

1.92.207

Cucina / Kuchyně / Kitchen

Ref. / Kód / Nr.:



Monocomando cucina elettronico

Miscelatore

Elektronická dřezová baterie se směšovačem
Se směšovačem

*Electronic sink mixer
Cold and warm water*

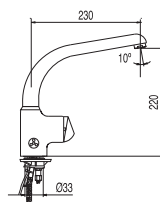

Cr

1.92.445

Cr = Cromo/Chrom/Chrome

TOUCH-TRES

Bagno / Koupelna / Bath

Ref. / Kód / Nr.:



Lavabo elettronico TOUCH-TRES

Sistema sensibile al tatto.
Senza premere.

Batterie s elettronickým řízením TOUCH-TRES

Systém citlivý na dotyk. Za účelem spuštění - dotknout (netlačit)

Electronic wash-basin TOUCH-TRES

Sensitive system to the touch. No press.

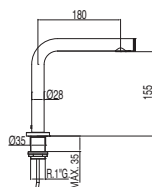

Un'acqua

Pro studenou vodu (nebo vstupně smíšenou)

Only cold water



Brevettato®

Patentovaný®

Patented®

Cr 061.447.01

Miscelatore

Se směšovačem

Cold and warm water



Brevettato®

Patentovaný®

Patented®

Cr 061.448.01



Cucina elettronica TOUCH-TRES

Sistema sensibile al tatto.
Senza premere.

Dřezové elektronické baterie TOUCH-TRES

Systém citlivý na dotyk. Za účelem spuštění - dotknout (netlačit)

Electronic kitchen taps TOUCH-TRES

Sensitive system to the touch. No press.

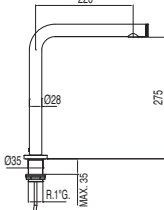

Un'acqua

Pro studenou vodu (nebo vstupně smíšenou)

Only cold water



Brevettato®

Patentovaný®

Patented®

Cr 1.61.445

Miscelatore

Se směšovačem

Cold and warm water

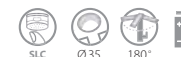

Brevettato®

Patentovaný®

Patented®

Cr 1.61.446



Miscelatore due acque CON TUBI FLESSIBILI

(TRESTRONIC, TOUCH-TRES, TEMPO-TRES)

Míchač vody S FLEXIBILNÍMI TRUBKAMI

(TRESTRONIC, TOUCH-TRES, TEMPO-TRES)

Two-water mixer WITH FLEXIBLE PIPES

(TRESTRONIC, TOUCH-TRES, TEMPO-TRES)

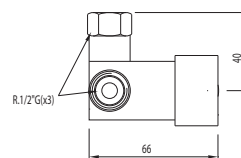

Cr 1.92.507.30



Dispenser automatico di sapone per le mani
 Automatický dávkovač mýdla
 Automatic hand soap dispenser

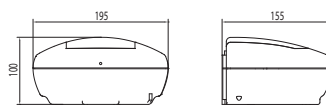

BI 092.636.01



Asciugacapelli automatico
 Automatický vysoušeč vlasů
 Automatic hair dryer

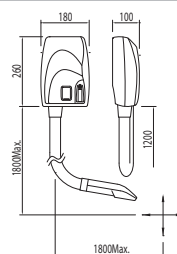

BI 092.636.02



Asciugamani automatico
 Automatický osoušeč rukou
 Automatic hand dryer

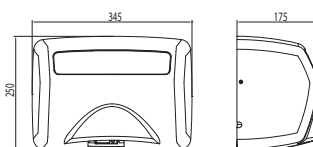

BI 092.636.03

Ricambi / Náhradní díly / Spare parts

	<p>Invertitore automatico Automatický přepínač <i>Diverter</i></p> <p style="text-align: right;">91.92.335.03</p>	<p>Fonte di alimentazione concavi di connessione elettrovalvola (per ref. / Kód / for Nr.: 1.92.103, 1.92.105, 1.92.445)</p> <p>Zdroj napájení, obsahuje kabely k připojení elektroventilů <i>Power supply intake with wires for connection with electronic valves</i></p> <p style="text-align: right;">1.92.103.10</p>
	<p>Sensore TRESTRONIC Čidlo pohybu TRESTRONIC <i>TRESTRONIC sensor</i></p> <p style="text-align: right;">91.92.606.30</p>	
	<p>Rubinetto di arrestocon filtro Rohový ventil s filtrem <i>Gate-valve with filter</i></p> <p style="text-align: right;">Cr 91.34.525</p>	<p>Scatola elettronica di rilevamento Dal 2011 / od 2011 / since 2011 (per ref. / Kód / for Nr.: 061.447.01, 61.448.01, 92.606.03, 92.906.03)</p> <p>Elektronická skříň snímače <i>Electronic detection box</i></p> <p style="text-align: right;">299.180.01</p>
	<p>Elettrovalvole (per ref. / Kód / for Nr.: 1.92.103, 1.92.105, 1.92.445) Elektroventily <i>Electronic valves</i></p> <p style="text-align: right;">1.92.103.13</p>	<p>Scatola elettronica di rilevamento (per ref. / Kód / for Nr.: 061.447.01, 61.448.01, 92.606.03, 92.906.03)</p> <p>Elektronická skříň snímače <i>Electronic detection box</i></p> <p style="text-align: right;">299.180.02</p>
	<p>Set bloccaggio occulto (per ref. / Kód / for Nr.: 061.447.01, 61.448.01, 92.606.03, 92.906.03) Ozdobný kroužek pro schování montážní sady <i>To hide locking set</i></p> <p style="text-align: right;">91.92.606.34</p>	

RUBINETTERIA SPECIALE / SPECIÁLNÍ BATERIE / SPECIAL TAPWARE

PATENT System



RUBINETTERIA SPECIALE / SPECIÁLNÍ BATERIE / SPECIAL TAPWARE

Kit per doccia / Sprchové soupravy / Shower kits

Ref. / Kód / Nr.:



Monocomando ad incasso per bidé WC CUADRO
Supporto a destra o a sinistra, intercambiabile. Flesso satinato.

Záchodová baterie se směšovačem teplot CUADRO
Pravý nebo levý podstavec, vyměnitelný. Hadice satin.

Concealed single lever bidet/toilets CUADRO
Left or right support, interchangeable. Sateen hose.



OTTONE
MOSAZ
BRASS

	Cr	006.123.01	
	Cr	006.123.02 *	



91.30.190



Monocomando ad incasso per bidé WC MAX
Supporto a destra o a sinistra, intercambiabile. Flesso satinato.

Záchodová baterie se směšovačem teplot MAX
Pravý nebo levý podstavec, vyměnitelný. Hadice satin.

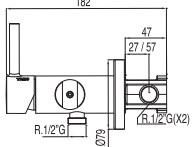
Concealed single lever bidet/toilets MAX
Left or right support, interchangeable. Sateen hose.

OTTONE
MOSAZ
BRASS

	Cr	1.34.123	
	Cr	1.34.122 *	

91.34.591



Monocomando ad incasso per bidé WC MAX
Canna girevole e flesso satinato

Záchodová baterie se směšovačem teplot MAX
Nástavec ruční sprchy s tlačítkem uzavírajícím vodní proud a hadice satin

Concealed single lever bidet/toilets MAX
Rotating spout sateen hose



Brevettato*
Patentovaný*
Patented*



OTTONE
MOSAZ
BRASS

	Cr	1.62.113	
---	----	----------	--



91.34.592.10



Monocomando ad incasso per bidé WC MAX
Flesso satinato

Záchodová baterie se směšovačem teplot MAX
Hadice satin

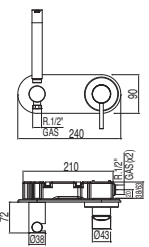
Concealed single lever bidet/toilets MAX
Sateen hose

OTTONE
MOSAZ
BRASS

	Cr	1.62.123	
	Cr	1.62.122 *	

91.34.591

Cr = Cromo/Chrom/Chrome

 Raccomandabile installare la valvola SIMPLE RAPID (non inclusa)
Doporučuje se použít ventil Simple Rapid (není v ceně)
Ideal assembly with SIMPLE RAPID valve (This is not included)

* **Opzione Cartongesso**
Možnost pro sádkartonové panely
Optie gips

RUBINETTERIA SPECIALE / SPECIÁLNÍ BATERIE / SPECIAL TAPWARE

Ref. / Kód / Nr.:



Monocomando ad incasso per bidé WC LEX
Supporto a destra o a sinistra, intercambiabile.
Flesso satinato

Záchodová baterie se směšovačem teplot LEX
Pravý nebo levý podstavec, vyměnitelný.
Hadice satin

Concealed single lever bidet/toilets LEX

*Left or right support, interchangeable.
Sateen hose*

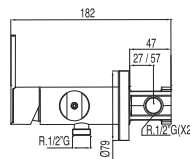

OTTONE
MOSAZ
BRASS



Cr 1.81.223
Cr 1.81.222 *



Monocomando ad incasso per bidé WC LEX
Canna girevole e flesso satinato

Záchodová baterie se směšovačem teplot LEX
Nástavec ruční sprchy s tlačítkem uzavírajícím vodní proud a hadice satin

Concealed single lever bidet/toilets LEX

Rotating spout sateen hose

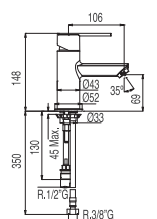

Brevettato®

Patentovaný®

Patented®



Cr 1.81.113



Monocomando ad incasso per bidé WC LEX
Flesso satinato

Záchodová baterie se směšovačem teplot LEX
Hadice satin

Concealed single lever bidet/toilets LEX

Sateen hose

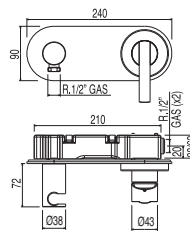

OTTONE
MOSAZ
BRASS



Cr 1.81.123
Cr 1.81.122 *



N

Monocomando ad incasso per bidé WC ALPLUS
Supporto a destra o a sinistra, intercambiabile.
Flesso satinato

Záchodová baterie se směšovačem teplot ALPLUS
Pravý nebo levý podstavec, vyměnitelný.
Hadice satin

Concealed single lever bidet/toilets ALPLUS

*Left or right support, interchangeable.
Sateen hose*

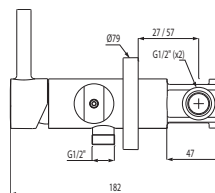

OTTONE
MOSAZ
BRASS



Cr 203.223.01
Cr 203.222.01 *



N

Monocomando ad incasso per bidé WC ALPLUS
Canna girevole e flesso satinato

Záchodová baterie se směšovačem teplot ALPLUS
Nástavec ruční sprchy s tlačítkem uzavírajícím vodní proud a hadice satin

Concealed single lever bidet/toilets ALPLUS

Rotating spout sateen hose

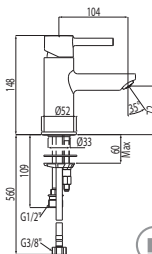

Brevettato®

Patentovaný®

Patented®



Cr 203.113.01



N

Monocomando ad incasso per bidé WC ALPLUS
Flesso satinato

Záchodová baterie se směšovačem teplot ALPLUS
Hadice satin

Concealed single lever bidet/toilets ALPLUS

Sateen hose

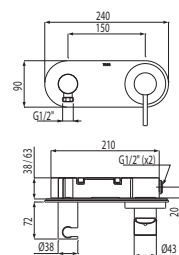

OTTONE
MOSAZ
BRASS



Cr 203.123.01
Cr 203.122.01 *

Cr = Cromo/Chrom/Chrome



Raccomandabile installare la valvola SIMPLE RAPID (non inclusa)
Doporučuje se použít ventil Simple Rapid (není v ceně)
Ideal assembly with SIMPLE RAPID valve (This is not included)

* Opzione Cartongesso
Možnost pro sádkartonové panely
Optie gips



Monocomando lavabo
Umyvadlová baterie
Single lever washbasin mixer

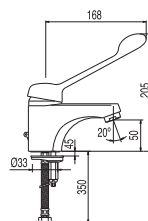

91.34.290

Cr

1.70.103.02.11



Doccia termostatica
Doccia anticalcarea (299.631.03). Flessibile satin (91.34.609.15). Indicato per persone con disabilità fisiche

Termostatický vanový
Sprchová koncovka se systémem proti tvorbě vodního kamene (299.631.03), hadice satin (91.34.609.15). Ruční sprcha hadice satin.
Určeno pro osoby s fyzickým handicapem

Wall thermostatic shower mixer
Shower Antilime (299.631.03). Shower hose satin (91.34.609.15). Suitable for persons with physical disabilities.



TRES TOUCH-COOL®

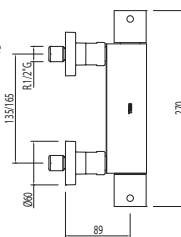

Cr

090.964.01



Vasca-Doccia termostatica
Doccia anticalcarea (299.631.03). Flessibile satin (91.34.609). Indicato per persone con disabilità fisiche

Termostatická vanová a sprchová baterie
Sprchová koncovka se systémem proti tvorbě vodního kamene (299.631.03), hadice satin (91.34.609). Ruční sprcha hadice satin.
Určeno pro osoby s fyzickým handicapem

Wall thermostatic shower mixer
Shower Antilime (299.631.03). Shower hose satin (91.34.609). Suitable for persons with physical disabilities.



TRES TOUCH-COOL®

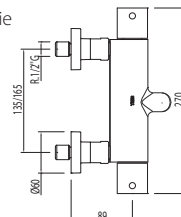

Cr

090.974.01



Monocomando a muro gruppo fuso. Leva medicale
Nastěnná směšovací baterie (litá výtoková hubice) Lékařská páka
Single lever wall sink mixer cast spout. With clinic lever

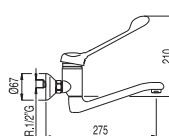

91.34.290 135-165

Cr

1.72.318.11



Monocomando a muro gruppo fuso. Leva medicale
Nastěnná směšovací baterie (litá výtoková hubice) Lékařská páka
Single lever single hole sink mixer With clinic lever

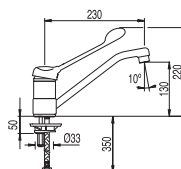

Cr

1.72.333.11



Leva medicale
(per ref.: ECO-TRES, EME/50, MONOTRES 2000, EME/40, COMPAC-TRES)
Lékařská páka
(katalogové č.: ECO-TRES, EME/50, MONOTRES 2000, EME/40, COMPAC-TRES)
Clinic lever
(for Nr.: ECO-TRES, EME/50, MONOTRES 2000, EME/40, COMPAC-TRES)



Cr

91.34.011

RUBINETTERIA SPECIALE / SPECIÁLNÍ BATERIE / SPECIAL TAPWARE

Giardino/Piscina / Zahrada/Bazén / Garden/Pool

Ref. / Kód / Nr.:



Doccia da giardino o piscina
Monocomando per acqua fredda e calda

Sprcha do zahrady či k bazénu
Jednopáková baterie na studenou a teplou vodu

Shower for garden or pool
Hot and cold water mixer tap

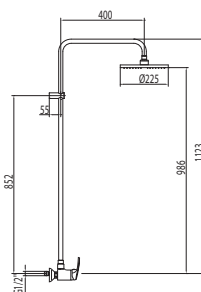

Cr 070.995.01



Doccia da giardino o piscina
Temporizzata con 1 tipo di acqua

Sprcha do zahrady či k bazénu
Časová baterie se stálou teplotou vody

Shower for garden or pool
Automatic shut-off single water temperature tap

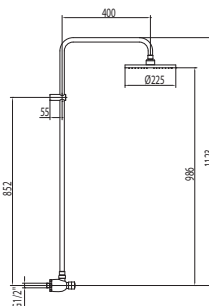

Cr 012.995.01

N



Rubinetto da Giardino

Zahradní kohout
tap for garden

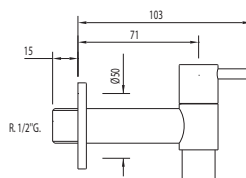

Cr 034.501.01

N



Rubinetto da Giardino

Zahradní kohout
tap for garden

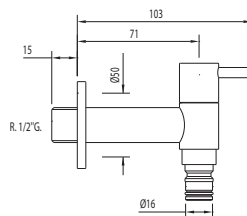

Cr 034.501.02

Cr = Cromo/Chrom/Chrome

Cucina / Kuchyně / Kitchen

Ref. / Kód / Nr.:



Tubo lavello
Stojánková výtoková hubice
Tube spout

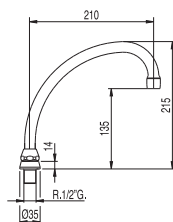

Cr 1.12.441

Gruppo a pedale
Ventil s nožním otevíráním
Pedal water tap

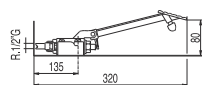

Miscelatore
Se směšovačem
Cold and warm water

Cr 1.12.370

Un'acqua
Pro studenou vodu (nebo
vstupně smíšenou)
Only cold water

Cr 1.12.360

Parrucchieri / Kadeřnictví / Hair salon fixtures

Ref. / Kód / Nr.:

Monocomando parrucchiera
Kadeřnická baterie
Hairdresser's shop

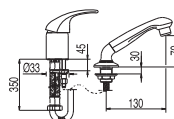

91.34.288

Cr 1.72.450

Vino / Víno / Wine

Ref. / Kód / Nr.:



Rubinetto vino N° 0
Kran na víno N° 0
Wine tap N° 0

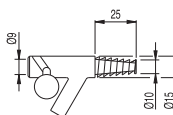

Cr 0.00.010





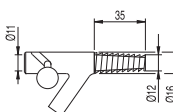







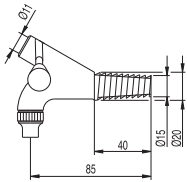

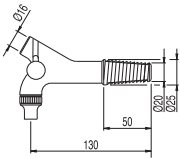
Rubinetto vino N° 5
Kran na víno N° 5
Wine tap N° 5

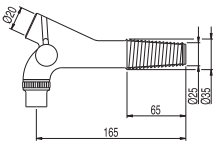

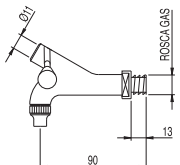
Cr 0.05.010

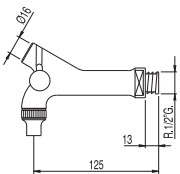
Cr = Cromo/Chrom/Chrome

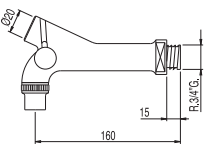
RUBINETTERIA SPECIALE / SPECIÁLNI BATERIE / SPECIAL TAPWARE

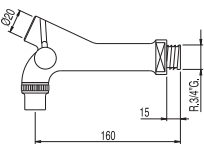
		Ref. / Kód / Nr.:	
	<p>Rubinetto vino N° 1/C Kran na víno N° 1/C <i>Wine tap N° 1/C</i></p>		Cr 0.01.010
	<p>Rubinetto vino N° 2/C Kran na víno N° 2/C <i>Wine tap N° 2/C</i></p>		Cr 0.02.010
	<p>Rubinetto vino N° 3/C Kran na víno N° 3/C <i>Wine tap N° 3/C</i></p>		Cr 0.03.010
	<p>Rubinetto vino N° 1/N Kran na víno N° 1/N <i>Wine tap N° 1/N</i></p>		3/8" G.
			Cr 0.01.000
	<p>Rubinetto vino N° 2/N Kran na víno N° 2/N <i>Wine tap N° 2/N</i></p>		1/2" G.
			Cr 0.01.001
	<p>Rubinetto vino N° 3/N Kran na víno N° 3/N <i>Wine tap N° 3/N</i></p>		3/8" G.
			Cr 0.02.000
	<p>Rubinetto vino N° 3/N Kran na víno N° 3/N <i>Wine tap N° 3/N</i></p>		1/2" G.
			Cr 0.03.000

Cr = Cromo/Chrom/Chrome



TRES-DUO®

Sistema a basso consumo d'acqua con apertura del rubinetto in due posizioni. Nella posizione intermedia, si consuma il 50% dell'acqua.

Systém nízké spotřeby vody s nastavením páčky do dvou poloh. V prostřední poloze se spotřebovává 50% vody.

Water saving system with a two-position handle. The middle position allows for a 50% water saving.

Il 90% delle volte che utilizziamo un rubinetto, in bagno o in cucina, non abbiamo bisogno di utilizzare il flusso massimo. Con questo sistema si ha un minor consumo di acqua e di energia.

V 90% případů používání baterie v koupelně nebo v kuchyni nepotřebujeme využívat maximální průtok. Díky tomuto systému dosáhneme nižší spotřeby vody a energie.

When we use a basin or kitchen tap, 90% of the time we do not need the maximum flow. With this system, we can obtain greater water and energy savings.



COLD-TRES®

Sistema a basso consumo energetico in cui il rubinetto si apre sempre con acqua fredda, evitando inutili accensioni dello scaldabagno.

Systém nízké spotřeby energie, kdy se baterie vždy otevírá se studenou vodou, zamezuje zbytečnému zapínání ohřívače.

Energy-saving system whereby the tap always runs cold water first, meaning that the water heater does not switch on unnecessarily.

Aprendo il rubinetto con la leva in posizione centrale, si consuma solo acqua fredda ed è l'utente che decide quando effettivamente desidera utilizzare l'acqua calda spostando la leva verso sinistra, il che comporta un notevole risparmio di energia.

Při nastavení páčky na střední polohu se spotřebovává pouze studená voda a je jen na spotřebiteli, zda posunutím páčky doleva použije i teplou vodu, což v důsledku přináší vysokou úsporu energie.

When the tap is turned on in the central position, only cold water is used. The consumer decides when he or she wants to use hot water, providing great energy savings.



PROTEC-TRES®

Sistema di protezione contro le scottature, che consente di definire la posizione di massima apertura della leva per l'acqua calda.

Systém ochrany, který zamezuje opaření a umožňuje zvolit maximální polohu páky pro tok teplé vody.

Anti-scalding protection system allows the user to decide the maximum lever opening position for hot water.

A seconda della posizione dell'anello Protec-Tres®, s'imposta la corsa della leva in modo da poter regolare la temperatura massima dell'acqua.

Podle polohy kroužku Protec-Tres®, který určuje dosah páky, můžete nastavit maximální teplotu vody.

The position of the Protec-Tres® ring determines the movement of the lever, so that you can adjust the maximum temperature of the water.

EOEFFICIENTE / ECOÚČINNOSTÍ / ECOEFFICIENT

Lavabi / Umyvadla / Basins		Ref. / Kód / Nr.:
	Monocomando lavabo MAX-TRES Umyvadlová baterie MAX-TRES <i>Single lever washbasin mixer MAX-TRES</i>	  
	91.34.385.10 Cr 1.62.104.02	
	Monocomando lavabo BM-TRES Umyvadlová baterie BM-TRES <i>Single lever washbasin mixer BM-TRES</i>	  
	91.34.270.10 Cr 1.39.104	
	Monocomando lavabo BM-TRES Umyvadlová baterie BM-TRES <i>Single lever washbasin mixer BM-TRES</i>	  
	91.34.270.10 Cr 1.17.104	
	Monocomando lavabo K-TRES Umyvadlová baterie K-TRES <i>Single lever washbasin mixer K-TRES</i>	  
	91.34.270.10 Cr 1.69.104	
	Monocomando lavabo PRIMA Umyvadlová baterie PRIMA <i>Single lever washbasin mixer PRIMA</i>	  
	91.34.270.10 Cr 1.85.104	
	Monocomando lavabo MONOTRES 2000 Umyvadlová baterie MONOTRES 2000 <i>Single lever washbasin mixer MONOTRES 2000</i>	  
	91.34.270.10 Cr 1.72.104	
		 
		91.34.270.10 Cr 1.77.104

Cr = Cromo/Chrom/Chrome

 Raccomandabile installare la valvola SIMPLE RAPID (non inclusa)
 Doporučuje se použít ventil Simple Rapid (není v ceně)
 Ideal assembly with SIMPLE RAPID valve (This is not included)



ECOEFFICIENTE / ECOÚČINNOSTÍ / ECOEFFICIENT

Ref. / Kód / Nr.:



Monocomando lavabo
ECO-TRES

Umyvadlová baterie
ECO-TRES

Single lever washbasin mixer
ECO-TRES

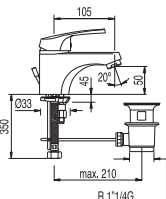

91.34.270.10

Cr

1.70.104.02



91.34.270.10

Cr

1.75.104.02

Monocomando lavabo LEX-TRES

Umyvadlová baterie LEX-TRES

Single lever washbasin mixer LEX-TRES

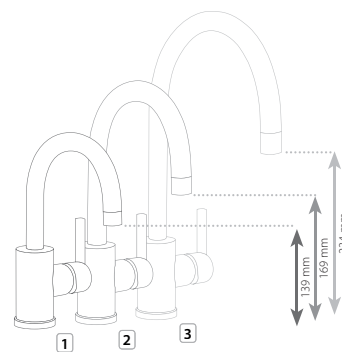

91.34.592

Cr

1.81.703

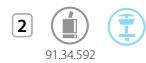

91.34.592

Cr

1.81.403

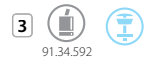

91.34.592

Cr

1.81.303

N

Monocomando lavabo ALPLUS

Umyvadlová baterie ALPLUS

Single lever washbasin mixer ALPLUS

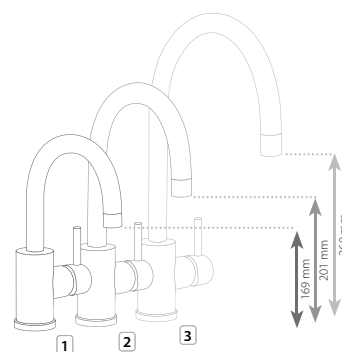

91.34.592

Cr

203.703.01

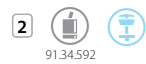

91.34.592

Cr

203.403.01

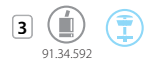

91.34.592

Cr

203.303.01



Cr = Cromo/Chrom/Chrome

N

Monocomando lavabo MAX-TRES

Umyvadlová baterie MAX-TRES

Single lever washbasin mixer MAX-TRES

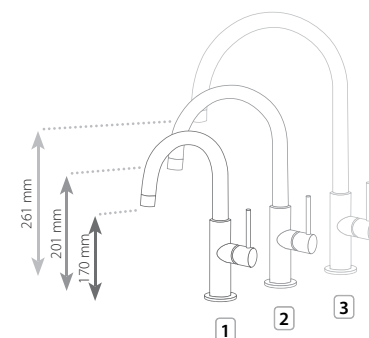

1	91.30.190	Cr	062.904.03
2	91.30.190	Cr	062.904.02
3	91.30.190	Cr	062.904.01

N

Monocomando lavabo MAX-TRES

canna 35x15 mm.

Umyvadlová baterie MAX-TRES

Výtoková hubice 35x15 mm.

Single lever washbasin mixer MAX-TRES
spout 35x15 mm.

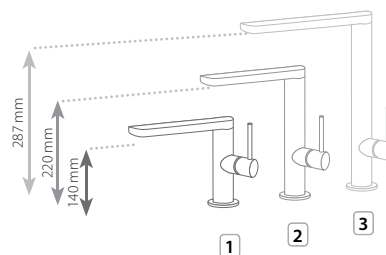

1	91.30.190	Cr	062.905.03
2	91.30.190	Cr	062.905.02
3	91.30.190	Cr	062.905.01

Cr = Cromo/Chrom/Chrome

Raccomandabile installare la valvola SIMPLE RAPID (non inclusa)
Doporučuje se použít ventil Simple Rapid (není v ceně)
Ideal assembly with SIMPLE RAPID valve (This is not included)

ECOEFFICIENTE / ECOÚČINNOSTÍ / ECOEFFICIENT

Ref. / Kód / Nr.:

Monocomando lavabo LOFT-TRES

Umyvadlová baterie LOFT-TRES

Single lever washbasin mixer LOFT-TRES

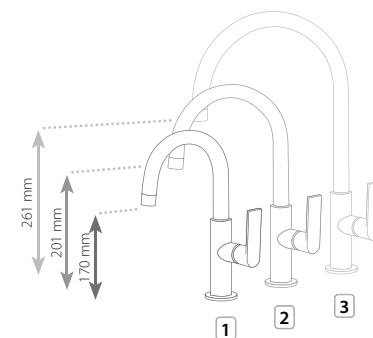

1	91.30.190	Cr	200.205.04
2	91.30.190	Cr	200.205.05
3	91.30.190	Cr	200.205.06

Monocomando lavabo LOFT-TRES

canna 35x15 mm.

Umyvadlová baterie LOFT-TRES

Výtoková hubice 35x15 mm.

Single lever washbasin mixer LOFT-TRES

spout 35x15 mm.

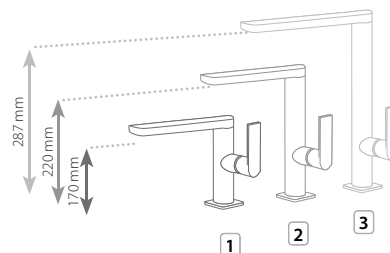

1	91.30.190	Cr	200.205.01
2	91.30.190	Cr	200.205.02
3	91.30.190	Cr	200.205.03



Cr = Cromo/Chrom/Chrome

 Raccmandabile installare la valvola SIMPLE RAPID (non inclusa)
Doporučuje se použít ventil Simple Rapid (není v ceně)
Ideal assembly with SIMPLE RAPID valve (This is not included)

Bidet / Bidety / Bidets

Ref. / Kód / Nr.:



Monocomando bidet LEX-TRES

Bidetová baterie LEX-TRES
Single lever bidet mixer LEX-TRES

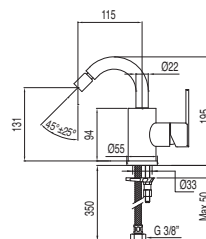

91.34.592

Cr

1.81.224

N



Monocomando bidet ALPLUS

Bidetová baterie ALPLUS
Single lever bidet mixer ALPLUS

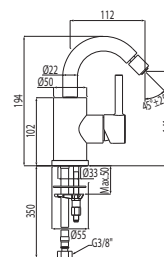

91.34.592

Cr

203.224.01

Cucina / Kuchyně / Kitchen

Ref. / Kód / Nr.:



Monocomando lavello verticale LOFT-TRES
cana 34x15 mm.

Dřezová baterie s vrchní výtokovou hubicí LOFT-TRES
Výtoková hubice 34x15 mm.

Single lever single hole sink mixer LOFT-TRES
spout 34x15 mm.

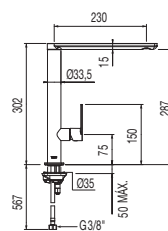

Ø 35

360°

91.30.190

Cr

Ac

- 200.440.01.AM
- 200.440.01.NA
- 200.440.01.RO
- 200.440.01.VI
- 200.440.01.FU
- 200.440.01.VE
- 200.440.01.MA
- 200.440.01.NE
- 200.440.01.BL
- 200.440.01
- 200.440.01.AC



Monocomando lavello verticale CUADRO-TRES
cana 34x10 mm.

Dřezová baterie s vrchní výtokovou hubicí CUADRO-TRES
výtoková hubice 34x10 mm.

Single lever single hole sink mixer CUADRO-TRES
spout 34x10 mm

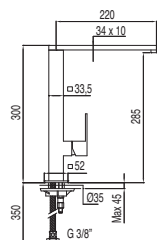

Ø 35

360°

91.30.190

Cr

Ac

Brevettato®
Patentovaný®
Patented®

- 1.06.486.AM
- 1.06.486.NA
- 1.06.486.RO
- 1.06.486.VI
- 1.06.486.FU
- 1.06.486.VE
- 1.06.486.MA
- 6.06.486
- 4.06.486
- 1.06.486
- 5.06.486.03

Cr = Cromo/Chrom/Chrome Ac = Acciaio/Ocel/Steel

= si veda pagina/viz ste/page 598

Ref. / Kód / Nr.:



Monocomando lavello verticale CUB-TRES

Dřezová baterie s vrchní výtokovou hubicí CUB-TRES

Single lever single hole sink mixer CUB-TRES

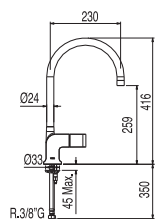

Cr 1.87.440



Monocomando lavello verticale MAX-TRES

Dřezová baterie s vrchní výtokovou hubicí MAX-TRES

Single lever single hole sink mixer MAX-TRES

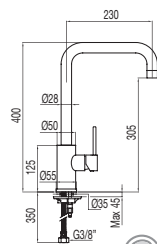

Cr 1.62.541



Monocomando lavello verticale MAX-TRES

Dřezová baterie s vrchní výtokovou hubicí MAX-TRES

Single lever single hole sink mixer MAX-TRES

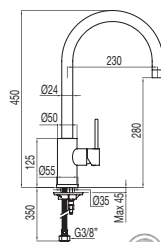

Cr 1.62.540

N



Monocomando lavello verticale MAX-TRES

Dřezová baterie s vrchní výtokovou hubicí MAX-TRES

Single lever single hole sink mixer MAX-TRES

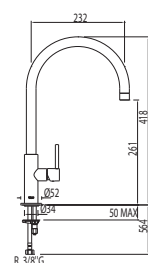

Cr 062.542.01



Monocomando lavello verticale LEX-TRES

Dřezová baterie s vrchní výtokovou hubicí LEX-TRES

Single lever single hole sink mixer LEX-TRES

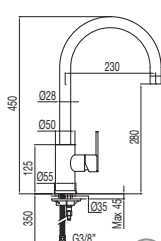

Cr 1.81.540



Monocomando lavello verticale ABBATTIBILE-MAX-TRES

Dřezová baterie s vrchní výtokovou hubicí SKLOPNÁ

Single lever single hole sink mixer FOLDING-MAX-TRES

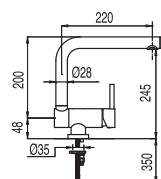









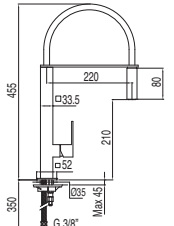



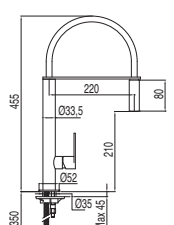



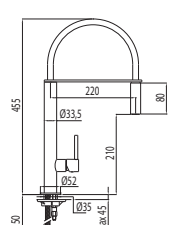

Cr 1.30.335

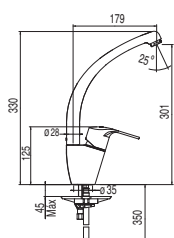

Cr = Cromo/Chrom/Chrome

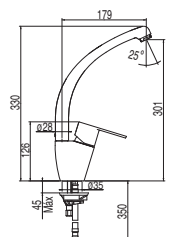
ECOEFFICIENTE / ECOÚČINNOSTÍ / ECOEFFICIENT

			Ref. / Kód / Nr.:	
	<p>Monocomando livello verticale CUADRO-TRES estraibile</p> <p>Dřezová baterie s vrchní výtokovou hubicí CUADRO-TRES S vyťahovací výtokovou hubicí</p> <p><i>Single lever single hole sink mixer CUADRO-TRES with removable spout</i></p>		<div style="border: 1px solid black; padding: 5px; margin-bottom: 10px;"> <p>Brevettato® Patentovaný® Patented®</p> </div> <ul style="list-style-type: none"> 1.06.487.AM 1.06.487.NA 1.06.487.RO 1.06.487.VI 1.06.487.FU 1.06.487.VE 1.06.487.MA 6.06.487 4.06.487 1.06.487 5.06.487.03 <p>Cr Ac</p>	
				
	<p>Monocomando livello verticale MAX-TRES estraibile</p> <p>Dřezová baterie s vrchní výtokovou hubicí MAX-TRES S vyťahovací výtokovou hubicí</p> <p><i>Single lever single hole sink mixer MAX-TRES with removable spout</i></p>		<div style="border: 1px solid black; padding: 5px; margin-bottom: 10px;"> <p>Brevettato® Patentovaný® Patented®</p> </div> <p>Cr 1.30.487</p>	
				
<p>N</p>		<p>Monocomando livello verticale MAX-TRES estraibile</p> <p>Dřezová baterie s vrchní výtokovou hubicí MAX-TRES S vyťahovací výtokovou hubicí</p> <p><i>Single lever single hole sink mixer MAX-TRES with removable spout</i></p>		<div style="border: 1px solid black; padding: 5px; margin-bottom: 10px;"> <p>Brevettato® Patentovaný® Patented®</p> </div> <p>Cr 062.487.01</p>
				
	<p>Monocomando livello verticale K-TRES</p> <p>Dřezová baterie s vrchní výtokovou hubicí K-TRES</p> <p><i>Single lever single hole sink mixer K-TRES</i></p>		<p>Cr 069.440.01</p>	
				
	<p>Monocomando livello verticale BM-TRES</p> <p>Dřezová baterie s vrchní výtokovou hubicí BM-TRES</p> <p><i>Single lever single hole sink mixer BM-TRES</i></p>		<p>Cr 017.440.01</p>	
				

Cr = Cromo/Chrom/Chrome Ac = Acciaio/Ocel/Steel

 = si veda pagina/viz ste/see page 598

Doccia / Sprchy / Showers

Ref. / Kód / Nr.:



Braccio doccia massaggio PLUS
con regolatore di portata, 3 posizioni

Rameno k hubici masáž plus
S regulací proudu, 3 proudy

Massage shower arm PLUS
flow regulation, 3 positions



Cr	1.34.818	
----	----------	--



Doccia anticalcare
6 l/m

Ruční sprcha se systémem
proti vzniku vodního kamene
6 l/m

Antilime shower
6 l/m



N	l/m: 6	Cr	299.631.07	
----------	--------	----	------------	--



Doccia anticalcare PAUSA
2 posizioni Riduzione di portata

Ruční sprcha se systémem proti vzniku
vodního kamene PAUSA
2 proudy. Snížení průtoku

Antilime shower PAUSA
2 positions Flow water reduction



Riduzione di portata
Snížení průtoku
Flow water reduction



	l/m: 14	l/m: *	Cr	1.34.531	
--	---------	--------	----	----------	--



Doccia massaggio PAUSA
3 posizioni Riduzione di portata

Sprchová masážní ruční sprcha PAUSA
3 proudy. Snížení průtoku

Massage shower PAUSA
3 positions Flow water reduction



Riduzione di portata
Snížení průtoku
Flow water reduction



	l/m: 14	l/m: 7	l/m: *	Cr	1.34.530	
--	---------	--------	--------	----	----------	--

Amplia gamma di rubinetteria ecologica / Velký výběr ekologických armatur / Extensive range in ecologic faucets

L'ampia gamma di prodotti ecologici si completa e integra
con la rubinetteria TERMOSTATICA, la rubinetteria ELETTRONICA
e la rubinetteria TEMPORIZZATA

Široké spektrum výrobků je tvořeno řadami Trestronic,
Tresmostatic, Tempotres.

*The large product range of ecological fixtures is complemented
with the thermostatic faucets, the electronic faucets and
the temporized faucets*



TRESMOSTATIC
(si veda pagina 259)
(viz ste 259)
(see page 259)



TRESTRONIC
(si veda pagina 495)
(viz ste 495)
(see page 495)



TEMPO-TRES
(si veda pagina 437)
(viz ste 437)
(see page 437)



TRES

Calle Penedès, 16-26
 Zona Industrial, Sector A
 08759 VALLIRANA (Barcelona)

Tel. (34) 93 683 38 82
 Fax. (34) 93 683 50 61

www.tresgriferia.com
exporttres@tresgriferia.com



ref. 7342013040 / ed. 01-2013