

Ceramica
VOGUE

Products & Solutions

Ceramica
VOGUE

5/ **Produzione** _Production _Produktion _Production

13/ **Prodotti** _Products _Produkte _Produits

19/ **VOGUE System**

Interni

Trasparenze

Flooring R10 B (A+B)

Grip R11 C (A+B+C)

103/ **VOGUE Link**

Interni Mix

Trasparenze Mix

Flooring Mix R10 B (A+B)

Grip Mix R11 C (A+B+C)

115/ **VOGUE Floor**

Interni40

Flooring40 R10

Grip40 B (A+B)

127/ **VOGUE Pool**

Bump C (A+B+C) V6

Special Pool

143/ **Referenze** _References _Referenzen _Références

193/ **Schede Tecniche** _Technical charts _Technische informationen _Fiches techniques

Piastrelle in gres porcellanato smaltato ingelivo

Frost-resistant glazed porcelain stoneware tiles
Glasierte und frostbeständige Feinsteinzeugfliesen
Carreaux en grès cérame émaillé ingélif

Produzione

Production

Produktion

Production



Ceramica Vogue, l'azienda

Dal 1978, anno in cui abbiamo iniziato la nostra attività, Ceramica Vogue ha messo le proprie competenze al servizio di progettisti e decoratori d'interni, affermandosi come azienda leader nella produzione di piastrelle in gres porcellanato smaltato per pavimenti e rivestimenti. Le elevate prestazioni tecniche e l'attenzione destinata alla ricerca estetica caratterizzano i prodotti a marchio Ceramica Vogue dando vita a un'ampia gamma di collezioni pensate per arredare con soluzioni innovative ambienti interni ed esterni. Un vasto catalogo di tinte unite declinate in molteplici formati e finiture, tutte corredate da pezzi speciali, ha fatto sì che la nostra immagine si affermasse con successo sui mercati europei e internazionali: parte della nostra produzione viene esportato all'estero, dove Ceramica Vogue è presente con uffici propri (Russia e Cina) e con agenti e distributori. Attualmente Ceramica Vogue, azienda del gruppo Altaeco S.p.A., produce annualmente 2.500.000 m² di piastrelle, dispone di magazzini coperti per oltre 20.000 m² e occupa circa 180 dipendenti.

Ceramica Vogue, the company

Since 1978, the year in which we began our activities, Ceramica Vogue has placed its skills at the service of designers and interior decorators, making its mark as a leader in the production of glazed porcelain stoneware floor and wall tiles. The high technical performance and attention to design can be seen in every Ceramica Vogue-branded product, creating a wide range of collections designed to furnish interior and exterior settings using innovative solutions. With a rich catalogue of plain colours in a multitude of sizes and finishes, all with special pieces, our image has successfully penetrated the European and international markets: part of our production is exported, where Ceramica Vogue is present with both its own offices (Russia and China) and through agents and distributors. Currently Ceramica Vogue, a company in the Altaeco S.p.A. group, produces 2,500,000 m² of tiles a year, has covered warehouses measuring more than 20,000 m² and employs 180 staff.

Ceramica Vogue, das Unternehmen

Seit der Aufnahme der Geschäftstätigkeiten im Jahr 1978 stellt Ceramica Vogue sein Fachwissen Architekten und Innenarchitekten zur Verfügung und hat sich heute als führender Hersteller von glasierten Feinsteinzeugfliesen für Bodenbeläge und Wandverkleidungen etabliert. Die hohen technischen Leistungen und die besondere Beachtung ästhetischer Gesichtspunkte kennzeichnen die Produkte mit der Marke Ceramica Vogue und haben eine breite Palette von Kollektionen entstehen lassen, die innovative Lösungen für Innen- und Außenbereiche zulassen. Eine umfassende Palette von Unifarben in einer Vielzahl von Formaten und Ausführungen, alle mit einer großen Auswahl an Formteilen, haben dafür gesorgt, dass wir unser Image erfolgreich auf den europäischen und außereuropäischen Märkten ausbauen konnten: Ein Teil unserer Produktion wird ins Ausland exportiert, wo Ceramica Vogue mit eigenen Büros (in Russland und China) und mit Handelsagenturen und Vertriebspartnern vertreten ist. Heute stellt Ceramica Vogue, ein Unternehmen der Altaeco SpA-Gruppe, jährlich 2,5 Millionen Quadratmeter Fliesen her und verfügt über mehr als 20.000 Quadratmeter überdachte Lagerflächen. Das Unternehmen beschäftigt rund 180 Mitarbeiter.

Ceramica Vogue, l'entreprise

Depuis 1978, l'année marquant le début de son activité, Ceramica Vogue a mis ses compétences au service de concepteurs et de décorateurs d'intérieurs, s'affirmant ainsi comme entreprise leader dans la production de carreaux en grès cérame émaillé pour les revêtements de sols et de murs. Les prestations techniques élevées et l'attention consacrée à la recherche esthétique caractérisent les produits de la marque Ceramica Vogue en donnant naissance à une vaste gamme de collections pensées pour décorer des intérieurs et des extérieurs en utilisant des solutions novatrices. Un riche catalogue de teintes unies déclinées dans de multiples formats et finitions, et s'accompagnant toutes de pièces spéciales, a permis à l'image de l'entreprise de s'affirmer avec succès sur les marchés européens et internationaux: une partie de la production est exportée à l'étranger où Ceramica Vogue est présente avec des bureaux (Russie et Chine), des agents et des distributeurs. Actuellement Ceramica Vogue, entreprise du groupe Altaeco S.p.A., produit annuellement 2 500 000 m² de carreaux, dispose de magasins couverts de plus de 20 000 m² et embauche environ 180 salariés.

Made in italy

Ceramica VOGUE è un'azienda italiana che inventa, progetta e realizza ceramiche di altissima qualità, apprezzate in tutto il mondo e capaci di soddisfare anche il cliente più esigente. Scegliere uno dei nostri prodotti significa optare per l'innovazione e per processi industriali che si basano su tecnologie all'avanguardia. Ogni nostra realizzazione è un equilibrato mix di materie prime eccellenti e tecniche produttive innovative, capaci di garantire la piacevolezza del risultato finale nel rispetto dell'ambiente che ci circonda. Siamo una realtà convinta che l'attenzione per l'estetica e l'utilizzo consapevole delle tecniche più evolute, siano alla base della creazione di prodotti di qualità. Tradizione italiana, cultura del lavoro, impegno nella ricerca e innovazione, cura dell'estetica: sono questi i fattori che ci differenziano e che fanno della Ceramica VOGUE un leader riconosciuto a livello internazionale nella produzione di piastrelle in gres porcellanato smaltato per pavimenti e rivestimenti.

Made in Italy

Ceramica VOGUE is an Italian company that invents, designs and produces high quality ceramics which are renowned around the world and able to satisfy even the most demanding customer. Choosing one of our products means choosing innovation and industrial processes which are based on cutting-edge technologies. Every one of our products is a well-balanced mix of excellent raw materials and innovative production techniques, which are able to guarantee a pleasing end result that respects the environment we live in. Our company is convinced that attention to aesthetics and the aware use of the most advanced techniques are fundamental for the creation of quality products. Italian tradition, work ethic, commitment to research and innovation, attention to design: these are the factors which set Ceramica VOGUE apart from the others, making it a recognised international leader in the production of glazed porcelain stoneware for floor and wall.

Made in Italy

Ceramica VOGUE ist ein italienischer Hersteller, der hochwertige Keramik entwirft, entwickelt und produziert. Keramik, die in der ganzen Welt geschätzt wird und in der Lage ist, auch den anspruchsvollsten Kunden zufriedenzustellen. Wenn Sie eines unserer Produkte wählen, bedeutet dies, dass Sie sich für Innovation und industrielle Prozesse entscheiden, die auf fortschrittlichen Technologien gründen. Jedes einzelne unserer Produkte ist eine ausgewogene Mischung aus erstklassigen Rohstoffen und innovativen Produktionstechniken, dies gewährleistet ein äußerst ansprechendes und umweltfreundliches Endergebnis. Wir sind überzeugt, dass die sorgfältige Beachtung ästhetischer Aspekte und der bewusste Einsatz von innovativer Technologie die Grundlagen für die Herstellung hochwertiger Produkte sind. Italienische Tradition, Arbeitskultur, Einsatz in den Bereichen Forschung und Innovation, sorgfältiges Beachten ästhetischer Gesichtspunkte: Diese Faktoren machen den feinen Unterschied aus und tragen dazu bei, dass sich Ceramica VOGUE zu einem international anerkannten führenden Hersteller von glasierten Feinsteinzeugfliesen für Bodenbeläge und Wandverkleidungen entwickelt hat.

Made in Italy

Ceramica Vogue est une entreprise italienne qui invente, conçoit et réalise des céramiques de très haute qualité, appréciées dans le monde entier et capables de satisfaire les plus exigeants des clients. Choisir l'un de nos produits signifie opter pour l'innovation et pour des processus industriels qui se basent sur des technologies à l'avant-garde. Chacune de nos réalisations est un mélange équilibré d'excellentes matières premières et de techniques de production novatrices, en mesure de garantir l'agrément du résultat final dans le respect de l'environnement qui nous entoure. Nous sommes une réalité convaincue que l'attention portée à l'esthétique alliée à l'utilisation consciente des techniques les plus évoluées sont à la base de la création de produits de qualité. Tradition italienne, culture du travail, engagement dans la recherche et l'innovation, soin de l'esthétique: voici les facteurs qui nous différencient et qui font de Ceramica Vogue un leader reconnu au niveau international dans la production de carreaux en grès cérame émaillé pour les revêtements de sols et de murs.



L'impegno per l'edilizia sostenibile

Ceramica Vogue esplicita il proprio impegno ecologico aderendo al Green Building Council Italia (GBC Italia), associazione no profit finalizzata a promuovere e a diffondere la cultura di un'edilizia sostenibile. La nostra azienda condivide filosofia e obiettivi del "costruire verde": la progressiva trasformazione del mercato verso modalità di costruzione responsabili ed ecocompatibili, la sensibilizzazione delle istituzioni e dell'opinione pubblica circa la necessità di evitare un impatto invasivo dell'edilizia sull'ambiente e la divulgazione agli operatori del settore di linee guida per una progettazione capace di influire positivamente sulla qualità della vita dei cittadini. GBC Italia è promotrice del sistema di certificazione indipendente e diffuso a livello globale LEED® (Leadership in Energy and Environmental Design), che garantisce le prestazioni di edifici costruiti secondo i parametri del risparmio idrico ed energetico, della riduzione delle emissioni di CO₂, del miglioramento della qualità ecologica degli interni e di una scelta responsabile del sito, dei materiali e delle risorse impiegate.

Committed to sustainable building

Ceramica Vogue expresses its green nature through its membership of the Green Building Council Italia (GBC Italia), a no-profit association which aims to promote and disseminate the green building culture. Our company shares the philosophy and objectives of "green building": the progressive transformation of the market towards responsible and eco-compatible construction methods, raising the awareness of the institutions and public opinion over the need to prevent buildings from having an invasive impact on the environment and the dissemination of guidelines among the sector to ensure that engineering has a positive influence on quality of life. GBC Italia promotes the global independent certification system LEED® (Leadership in Energy and Environmental Design), which guarantees the performance of buildings built using water and energy saving parameters, the reduction in emissions of CO₂, improvement of the green quality of interior design and the responsible choice of location, materials and resources used.

Engagement für nachhaltiges Bauen

Ceramica Vogue weist durch die Mitgliedschaft beim Green Building Council Italien (GBC Italien), einem gemeinnützigen Verein zur Förderung und Verbreitung der Kultur des nachhaltigen Bauens, auf den Einsatz des Unternehmens für den Umweltschutz hin. Unser Unternehmen teilt die Philosophie und die Ziele des "grünen Bauens": Allmähliche Veränderungen des Marktes, hinzu verantwortlichen und umweltfreundlichen Bauweisen, um Behörden und der Öffentlichkeit, die Notwendigkeit bewusst zu machen und zu vermeiden, dass Gebäude die Umwelt belasten. Das Aufstellen und die Verbreitung von Richtlinien für eine Architektur, die Lebensqualität in unseren Städten positiv beeinflussen kann. GBC Italien fördert das unabhängige, weltweit verbreitete und anerkannte Zertifizierungssystem LEED® (Leadership in Energy and Environmental Design), das die Gesamtenergieeffizienz von Gebäuden garantiert, die nach den Parametern der Wasser- und Energieeinsparung, der Reduzierung von CO₂-Emissionen, der Verbesserung der ökologischen Qualität der Innenräume und der verantwortlichen Wahl des Standorts, der Materialien und Ressourcen, gebaut werden.

L'engagement dans la construction durable

Ceramica Vogue explicite son engagement écologique en adhérant au Green Building Council Italia (GBC Italia), une association à but non lucratif visant à promouvoir et à divulguer la culture d'une construction durable. Notre entreprise partage la philosophie et les objectifs d'une "construction écologique": la transformation progressive du marché vers des modalités de construction responsables et éco-durables, la sensibilisation des institutions et de l'opinione publique au sujet de la nécessité d'éviter un impact invasif de la construction sur l'environnement et la divulgation aux opérateurs du secteur de lignes directrices pour une conception capable d'influer positivement sur la qualité de la vie des habitants. GBC Italia est la promotrice du système indépendant et répandu au niveau global LEED® (Leadership in Energy and Environmental Design) qui garantit les prestations d'édifices construits suivant les paramètres de l'économie hydrique et énergétique, de la réduction des émissions de CO₂, de l'amélioration de la qualité écologique des intérieurs et d'un choix responsable du site, des matériaux et des ressources utilisées.

POLITICA A CHILOMETRO ZERO

km0

Utilizzo di materie prime esclusivamente nazionali a impronta ecologica controllata
 The use of exclusively national raw materials with controlled green footprint
 Verwendung von ausschließlich heimischen Rohstoffen mit kontrolliertem ökologischen Fußabdruck
 Utilisation de matières premières exclusivement nationales et écologiquement contrôlées



RIUTILIZZO DELL'ACQUA



Riutilizzo al 100% delle acque reflue della produzione
 100% reuse of waste water from production
 42% reduction in the factory's water needs
 100% Wiederverwendung von Abwasser in der Produktion
 42%-ige Senkung des Wasserbedarfs im Werk
 Réutilisation à 100% des eaux usées de la production
 Réduction de 42% du besoin hydrique de l'établissement de production

RICICLO DEL VETRO

40%

Riutilizzo degli scarti del processo di riciclo del vetro nell'impianto del gres porcellanato
 Re-use of glass recycling process waste in the porcelain stoneware body
 Die Wiederverwendung der Abfälle aus dem Glas-Recycling in der Masse des Feinsteinzeugs
 Réutilisation des rebuts du processus de recyclage du verre dans la pâte du grès cérame

TAGLIO DELLE EMISSIONI

-10%

Minimo impatto nella produzione di gas serra. Emissioni ridotte di dieci volte rispetto al passato
 Minimum impact in the production of greenhouse gases. Emissions reduced by ten times that of the past
 Die minimale Freisetzung von Treibhausgasen. Die Emissionen sind im Vergleich zu früher zehnmals geringer
 Impact minimal dans la production de gaz de serre. Émissions dix fois inférieures par rapport au passé

RECUPERO SCARTI CRUDI

100%

Riciclo degli scarti crudi, reintegrati al 100% nella filiera di produzione
 Recycling of unfired waste, which is reused 100% in the production chain
 Wiederverwendung von Rohstoffabfall, der zu 100% wieder in die Produktionskette eingeführt wird
 Recyclage des rebuts bruts, réintégrés à 100% dans la filière de production

RECUPERO ENERGETICO

-40%

Recupero del calore del ciclo di produzione. Riduzione del 40% dell'uso di combustibili fossili
 Recovery of heat from the production cycle. 40% reduction in the use of fossil fuels
 Wärmerückgewinnung des Produktionszyklus. Um 40% gesenkte Nutzung fossiler Brennstoffe
 Récupération de la chaleur du cycle de production. Réduction de 40% de l'utilisation de combustibles fossiles



100%

RECUPERO SCARTI COTTI

Riciclo degli scarti cotti, riutilizzati al 100% come materiale inerte per l'edilizia
 Recycling of fired waste, which is 100% reused as inert material for building
 Recycling von gebrannten Abfällen, die zu 100% als Zuschlagstoffe für den Bau wiederverwertet werden
 Recyclage des rebuts cuits, réutilisés à 100% comme matériau inerte pour la construction

IMBALLAGGI SOSTENIBILI

100%

Imballaggi riciclabili al 100%. Pallet di giacenza e trasporto in conformità con lo standard IPPC FAO ISPM 15
 100% recyclable packaging. Stored pallets and transportation in conformity with the standard IPPC FAO ISPM 15
 Die Verpackungsmaterialien sind zu 100% wiederverwertbar. Die Lagerung und der Transport der Paletten erfolgt in Übereinstimmung mit dem IPPC-Standard ISPM 15 der FAO
 Emballages recyclables à 100%. Palette de stockage et de transport en conformité avec le standard IPPC FAO ISPM 15

Ecosostenibilità della produzione

Ceramica Vogue dedica la massima attenzione all'impatto ambientale della propria produzione, impegnandosi nella realizzazione di ceramiche che coniughino gli elevati standard qualitativi con la tutela della natura e con il rispetto dei criteri di uno sviluppo etico e sostenibile. L'intero ciclo di lavorazione dei prodotti è pensato in funzione dell'ottimizzazione delle risorse e della riduzione delle emissioni di anidride carbonica, grazie al riutilizzo delle materie prime e agli investimenti atti a garantire il recupero energetico. Adattando le proprie tecnologie e i propri impianti di produzione, Ceramica Vogue si è specializzata nel processo di riciclo del vetro e ad oggi utilizza nell'impasto del proprio gres porcellanato fino al 40% di una miscela di vetro e feldspato: ciò che prima era rifiuto diventa catalizzatore delle materie prime, migliorando le caratteristiche tecniche ed estetiche del prodotto finale. Il materiale di riciclo proviene da giacimenti situati in prossimità degli stabilimenti di lavorazione, in conformità con la politica a chilometro zero scelta dall'azienda.

Eco-sustainable production

Ceramica Vogue pays the utmost attention to the environmental impact of its production, and is committed to produce ceramics which combine the highest quality standards with environmental protection and the respect for ethical and sustainable development criteria. The entire production cycle is designed to optimise resources and reduce carbon dioxide emissions, by re-using raw materials and investing in systems that guarantee energy recovery. By adapting its technologies and production systems, Ceramica Vogue specialized itself in glass recycling, and today uses a mixture of glass and feldspar in its porcelain stoneware body in an amount up to 40%: what was once waste becomes a catalyst of raw materials, improving the technical and aesthetic characteristics of the end product. The recycled material comes from stores located near the factory, in line with the company's "zero-mileage" policy.

Umweltfreundliche Produktion

Ceramica Vogue widmet den Umweltauswirkungen ihrer Produktion die größte Aufmerksamkeit und engagiert sich für die Herstellung von Keramik, die hohe Qualitätsstandards mit Umweltfreundlichkeit verbindet und die Kriterien einer ethischen und nachhaltigen Entwicklung erfüllt. Der gesamte Produktionsprozess ist so konzipiert, dass die Ressourcen optimiert und die Kohlendioxid-Emissionen gesenkt werden. Dies ist dank der Wiederverwendung von Rohstoffen und durch Investitionen möglich, die die Rückgewinnung von Energie gewährleisten. Durch Anpassung der Technologien und Produktionsanlagen hat sich Ceramica Vogue auf das Recycling von Glas spezialisiert und nutzt in der Masse seines Feinsteinzeugs bis zu 40% einer Mischung von Glas und Feldspat: Was zuerst der Verschwendung von Rohstoffen Einhalt gebieten sollte, erwies sich bald als ein ausgezeichnetes Mittel, die technischen und ästhetischen Eigenschaften des Endprodukts zu verbessern. Das recycelte Material stammt aus Vorkommen in der Nähe der Produktionsstätten, wodurch lange Transportwege vermieden und so Energie gespart wird.

Éco-durabilité de la production

Ceramica Vogue consacre sa plus grande attention à l'impact environnemental de sa production, en s'engageant dans la réalisation de céramiques qui allient des standards qualitatifs élevés à la tutelle de la nature et au respect des critères d'un développement éthique et durable. L'ensemble du cycle de fabrication des produits est pensé en fonction de l'optimisation des ressources et de la réduction des émissions d'anhydride carbonique, grâce à la réutilisation des matières premières et aux investissements visant à garantir la récupération énergétique. En adaptant ses technologies et ses dispositifs de production, Ceramica Vogue s'est spécialisée dans le processus de recyclage du verre et utilise aujourd'hui, dans la pâte du grès cérame, jusqu'à 40% d'un mélange de verre et de feldspath: ce qui était un déchet auparavant devient un catalyseur des matières premières, en améliorant ainsi les caractéristiques techniques et esthétiques du produit final. Le matériau de recyclage provient de gisements situés à proximité des établissements de production, conformément à la politique "kilomètre zéro" choisie par l'entreprise.

VOGUE System

Interni

Trasparenze

Flooring R10 B (A+B)

Grip R11 C (A+B+C)

VOGUE Link

Interni Mix

Trasparenze Mix

Flooring Mix R10 B (A+B)

Grip Mix R11 C (A+B+C)

VOGUE Floor

Interni40

Flooring40 R10

Grip40 B (A+B)

VOGUE Pool

Bump C (A+B+C) V6

Special Pool

Prodotti

Products

Produkte

Produits

Giunto e componibilità dei formati

Le piastrelle di tutte le collezioni Ceramica Vogue sono progettate per essere montate in combinazione tra loro: i calibri dei diversi formati sono quindi compatibili. La possibilità di combinare secondo molteplici modalità i colori, le finiture e i formati rappresenta per i progettisti una soluzione ottimale, capace di soddisfare ogni tipo di esigenza tecnica senza tuttavia sottovalutare le necessità dettate da un'attenta ricerca estetica e decorativa. Le misure riportate indicano la dimensione di fabbricazione media riferita al calibro centrale di produzione. Le tolleranze di dimensione all'interno dello stesso calibro sono stabilite dalla normativa UNI EN 14411 e si compensano normalmente fugando il materiale come da noi indicato. È possibile che siano forniti calibri inferiori o superiori a quello centrale: ne deriva che le dimensioni di fabbricazione media possono variare di conseguenza. A questo proposito, si consiglia di indicare in fase di ordinazione dei materiali i formati che si intendono utilizzare in composizione e che dovranno perciò avere calibri compatibili.

Per ottenere un corretto risultato di posa il materiale deve essere posato con un giunto non inferiore a 2 mm.

Modularity and laying

The tiles in all of the Ceramica Vogue collections were designed to be laid in combination: the calibers of the different sizes are therefore compatible. The possibility to combine colours, finishes and sizes in a multitude of different ways is an excellent solution for designers, allowing them to satisfy all kinds of technical requirements without underestimating the demands for decoration and style. The measurements provided indicate the average production size referring to the central caliber. The size tolerances within the same caliber are laid down in the standard UNI EN 14411 and are usually compensated by laying the material as per our instructions. It is possible that lower or higher calibers than the central one are supplied: thus the average manufacturing sizes may vary. In this regard, it is recommended to indicate in the order the sizes you intend to use for the composition, in order to ensure that they are supplied with compatible calibers.

To obtain a correct laying result the material should be laid with joints of no less than 2 mm.

Fugen und Zusammenstellbarkeit der Formate

Die Fliesen aller Kollektionen von Ceramica Vogue wurden entwickelt, um miteinander kombiniert zu werden: Die Werkmaße der verschiedenen Formate sind daher miteinander kompatibel. Die Farben, Oberflächenausführungen und Formate können auf vielfältige Weise kombiniert werden, dies ist eine optimale Lösung für Designer, da alle technischen Anforderungen erfüllt, ohne ästhetische Gesichtspunkte und dekorative Wirkung außen vor zu lassen. Die angegebenen Maßzahlen beziehen sich auf die durchschnittlichen Herstellungsmaße in Bezug auf das zentrale Herstellungsmaß. Die Größentoleranzen innerhalb des gleichen Werkmaßes werden von der Norm UNI-EN 14411 festgelegt und werden in der Regel kompensiert, wenn die Ware mit den von uns angegebenen Fugenmaßen verlegt wird. Es können niedrigere oder höhere Werkmaße als das zentrale Werkmaß geliefert werden: Daher können die mittleren Herstellungsgrößen entsprechend variieren. Aus diesem Grund bitten wir Sie bei der Bestellung der Ware die Formate anzugeben, die miteinander kombiniert werden sollen und daher kompatible Werkmaße aufweisen müssen.

Für ein einwandfreies Ergebnis muss die Ware immer mit einer Fuge von mindestens 2 mm verlegt werden.

Joint et modularité des formats

Les carreaux de toutes les collections Ceramica Vogue sont conçus pour être montés assemblés les uns avec les autres: les calibres des différents formats sont donc compatibles. La possibilité d'assembler les couleurs, les finitions et les formats suivant de multiples modalités représente pour les concepteurs une solution optimale, capable de satisfaire chaque type d'exigence technique sans toutefois sous-évaluer les nécessités dictées par une attentive recherche esthétique et décorative. Les mesures reportées indiquent la dimension de fabrication moyenne référée au calibre central de production. Les tolérances de dimension à l'intérieur du même calibre sont établies par la norme UNI EN 14411 et se compensent normalement en jointoyant le matériau comme nous l'avons indiqué. Il est possible que les calibres fournis soient inférieurs ou supérieurs au calibre central: il en résulte donc que, par conséquent, les dimensions de fabrication moyenne peuvent varier. À ce sujet, il est conseillé d'indiquer, au moment de la commande des matériaux, les formats que l'on souhaite utiliser en assemblage et qui devront, par conséquent, présenter des calibres compatibles.

Afin d'obtenir un résultat de pose correct, le matériau doit être posé avec un joint non inférieur à 2 mm.

VOGUE System

Grip R11 C (A+B+C)

Finitura antiscivolo satinata per superfici bagnate, caratterizzata da aderenza elevata. Disponibile in 14 tonalità opache e in 3 formati. Satin non-slip finish for wet surfaces, with strong grip. Available in 14 matt colour shades and in 3 sizes.

Die satinierte, rutschfeste Ausführung für nasse Oberflächen ist durch hohe Haftung gekennzeichnet. In 14 Farben und 3 Formaten erhältlich. Finition anti-dérapante satinée pour des surfaces mouillées, caractérisée par une adhérence élevée. Disponible dans 14 tonalités mates et dans 3 formats.

Flooring R10 B (A+B)

Finitura antiscivolo satinata per superfici umide/asciutte, caratterizzata da buona aderenza. Disponibile in 14 tonalità opache e in 4 formati modulari. Satin non-slip finish for wet/dry surfaces, with good grip. Available in 14 matt colour shades and in 4 modular sizes.

Die satinierte rutschfeste Ausführung für feuchte/trockene Oberflächen ist durch hohe Haftung gekennzeichnet. In 14 Farben und 4 zusammenstellbaren Größen erhältlich. Finition anti-dérapante satinée pour des surfaces mouillées/sèches, caractérisée par une bonne adhérence. Disponible dans 14 tonalités et dans 4 formats modulaires.

Trasparenze

Finitura lucida, disponibile in 30 tonalità brillanti e in più formati modulari corredati di tozzetti e pezzi speciali.

Gloss finish, available in 30 brilliant colours and in several modular sizes, with insets and special pieces.

Die glänzende Ausführung ist in 30 leuchtenden Farben und in unterschiedlichen zusammenstellbaren Formaten mit Einlegern und Formteilen erhältlich.

Finition lustrée, disponible dans 30 tonalités brillantes et dans plusieurs formats modulaires accompagnés de cabochons et de pièces spéciales.

Interni

Finitura satinata, disponibile in 38 tonalità cromatiche e in più formati modulari corredati di tozzetti e pezzi speciali.

Satin-finish, available in 38 colour shades and several modular sizes, with insets and special pieces.

Die satinierte Ausführung ist in 38 Farben und in unterschiedlichen zusammenstellbaren Formaten mit Einlegern und Formteilen erhältlich.

Finition satinée, disponible dans 38 tonalités chromatiques et dans plusieurs formats modulaires accompagnés de cabochons et de pièces spéciales.

VOGUE Link

Interni Mix/Trasparenze Mix

Finitura satinata, disponibile in 21 tonalità formato 5x5 montato su fibra/Finitura lucida, disponibile in 17 tonalità brillanti formato 5x5 montato su fibra.

Satin finish, available in 21 shades, 5x5 size fibre-mounted/glossy finish, available in 17 glossy shades, 5x5 size fibre-mounted.

Satinierte Oberflächenausführung, in 21 Farbtönen im Format 5x5 auf Faser montiert erhältlich/Glänzende Oberflächenausführung in 17 glänzenden Farbtönen im Format 5x5 auf Faser montiert.

Finition satinée. Existe en 21 tonalités en 5x5 monté sur fibre/Finition lustrée. Existe en 17 tonalités brillantes en 5x5 monté sur fibre.

Flooring Mix R10 B (A+B)/Grip Mix R11 C (A+B+C)

Finitura antiscivolo satinata per superfici umide/asciutte, in 6 tonalità/Finitura antiscivolo satinata per superfici bagnate, in 6 tonalità formato 5x5 montato su fibra di vetro

Non-slip satin finish for damp/dry surfaces, in 6 shades/Satin non slip finish for wet surfaces, in 6 shades 5x5 size mounted on fibreglass

Rutschhemmende satinierte Oberflächenausführung für feuchte/trockene Oberflächen in 6 Farbtönen/Rutschhemmende satinierte Oberflächenausführung für nasse Oberflächen in 6 Farbtönen im Format 5x5 auf Glasfaser montiert

Finition antidérapante satinée pour surfaces humides/sèches. Existe en 6 tonalités/Finition antidérapante satinée pour surfaces mouillées. Existe en 6 tonalités en 5x5 monté sur fibre de verre.

VOGUE Floor

Interni40/Flooring40 R10

Finitura satinata, in 14 tonalità cromatiche nel formato 40x40/Finitura antiscivolo satinata per superfici asciutte, in 16 tonalità nel formato 40x40

Satin finish, in 14 shades in the 40x40 size/Satin non slip finish for dry surfaces, in 16 shades 40x40 size

Satinierte Oberflächenausführung, in 14 Farbtönen im Format 40x40/Rutschhemmende satinierte Oberflächenausführung für trockene Oberflächen in 16 Farbtönen im Format 40x40

Finition satinée. Existe en 14 tonalités chromatiques en 40x40/Finition antidérapante satinée pour surfaces sèches. Existe en 16 tonalités en 40x40.

Grip40 B (A+B)

Finitura antiscivolo satinata per superfici umide/asciutte, caratterizzata da buona aderenza., disponibile in 6 tonalità nel formato 40x40

Satin non-slip finish for damp/dry surfaces, with good grip, available in 6 shades in the 40x40 size

Rutschhemmende satinierte Oberflächenausführung für feuchte/trockene Oberflächen, die sich durch ihre gute Haftung auszeichnet, in 6 Farbtönen im Format 40x40 erhältlich

Finition antidérapante satinée pour surfaces humides/sèches, caractérisée par un bon niveau d'adhérence. Existe en 6 tonalités en 40x40.

VOGUE Pool

Bump c (A+B+C) v6

Finitura antiscivolo strutturata, disponibile in 8 tonalità nel formato 10x20

Textured non-slip finish, available in 8 shades in the 10x20 size

Rutschhemmende strukturierte Oberflächenausführung, in 8 Farbtönen im Format 10x20 erhältlich

Finition antidérapante structurée. Existe en 8 tonalités en 10x20

VOGUE System [pag. 19]

Ideato da Ceramica Vogue per soddisfare ogni esigenza di progettazione, il Vogue System si propone come soluzione d'arredo per spazi interni ed esterni ad uso pubblico e privato. Il sistema si articola in quattro finiture atte a rispondere a differenti necessità tecniche, declinate nelle medesime tonalità di un'ampia gamma cromatica e disponibili in più formati modulari. Colori e formati complementari consentono di realizzare numerose combinazioni e accostamenti, moltiplicando le possibilità d'impiego del Vogue System.

Designed by Ceramica Vogue to satisfy all kinds of design needs, the Vogue System offers furnishing solutions for interiors and exteriors for both public and private use. The system includes four different finishes which respond to various technical needs, which all come in the same rich range of colours and a range of modular sizes. Complementary colours and sizes can be used to create a multitude of combinations and patterns, multiplying the possibilities of use of the Vogue System.

Das Vogue System wurde von Ceramica Vogue entwickelt, um den unterschiedlichsten Planungsansprüchen gerecht zu werden. Es erweist sich als ideale Gestaltungslösung für Innen- und Außenräume im öffentlichen und privaten Bereich. Das System bietet vier Oberflächenausführungen für unterschiedliche technische Anforderungen. Sie sind in den gleichen Farbtönen einer breiten Farbpalette und in verschiedenen mit einander kombinierbaren Formaten erhältlich. Zusätzliche, komplementäre Farben und Größen erlauben zahlreiche Kombinationen und Zusammenstellungen, dabei werden die Einsatzmöglichkeiten des Vogue Systems vervielfacht.

Conçu par Ceramica Vogue afin de satisfaire chaque exigence en matière de conception, le Vogue System se présente comme une solution de décoration pour les intérieurs et les extérieurs à destination publique et privée. Ledit système se subdivise en quatre finitions en mesure de répondre à différentes nécessités techniques, déclinées dans les mêmes tonalités d'une vaste gamme chromatique et disponibles dans plusieurs formats modulaires. Les couleurs et les formats complémentaires permettent de réaliser de nombreuses combinaisons et assortiments, multipliant ainsi les possibilités d'utilisation du Vogue System.

VOGUE Link [pag. 103]

La collezione Vogue Link raggruppa prodotti che sono derivati dal Vogue System e con esso si integrano per formati e finiture. Pensata per soluzioni decorative sia in ambito residenziale che pubblico, ideale per pavimenti e rivestimenti in base alle caratteristiche della superficie utilizzata. Le molteplici proposte cromatiche offrono soluzioni progettuali in grado di rendere unico ogni ambiente.

The Vogue Link collection brings products originating from the Vogue System range together, resulting in a perfect match of sizes and finishes. Intended as decorative solutions for private and public applications, they are ideal for floor and wall coverings offering the benefits of the features of the surface used. The vast range of colours makes it possible to design solutions that will make any space truly unique.

Die Kollektion Vogue Link vereint Produkte, die vom Vogue System abgeleitet sind und dieses bezüglich der Formate und Oberflächenausführungen ergänzen. Sie ist für Dekorationslösungen sowohl im Wohnbereich als auch in der Öffentlichkeit gedacht und ideal für Fußböden und Verkleidungen, je nach den Eigenschaften der verwendeten Oberfläche. Das vielfältige farbliche Angebot bietet planerische Lösungen, die fähig sind, jede Umgebung einzigartig zu gestalten.

La collection Vogue Link comprend des produits dérivés du Vogue System dont elle intègre les formats et les finitions. Elle a été imaginée pour revêtir les sols et les murs des espaces résidentiels et publics, selon les caractéristiques de la surface utilisée. Les multiples propositions chromatiques présentent des projets permettant de donner à chaque espace un cachet tout à fait unique.

VOGUE Floor [pag. 115]

Le serie del Vogue Floor sono appositamente pensate per un uso a pavimento. Ricerca estetica, elevate prestazioni tecniche e un'ampia scelta cromatica permettono di ricoprire anche grandi superfici in spazi pubblici o privati.

The Vogue Floor series are designed specifically for floor tiling. Aesthetically sophisticated, they offer high performance and a wide range of colours, and can be used to cover even large spaces in public or private settings.

Die Serien Vogue Floor sind speziell für den Einsatz als Bodenbelag bestimmt. Anspruchsvolle Ästhetik, hohe technische Leistungen und eine große Farbauswahl machen sie besonders für große Flächen in öffentlichen oder privaten Bereichen geeignet.

Les séries du Vogue Floor sont pensées spécialement pour une utilisation au sol. Recherche esthétique, prestations techniques élevées et vaste choix chromatique permettent de recouvrir également de grandes surfaces dans des espaces publics ou privés.

VOGUE Pool [pag. 127]

La collezione Vogue Pool offre prodotti e pezzi speciali appositamente studiati per la progettazione e realizzazione di piscine.

Vogue Pool is a complete collection of products and special pieces specifically designed for the creation and installation of swimming pools.

Die Kollektion Vogue Pool bietet Produkte und Formteile, die speziell für die Planung und Errichtung von Schwimmbecken entwickelt wurden.

La collection Vogue Pool propose des produits et des pièces spéciales expressément conçus pour la conception et la réalisation de piscines.

VOGUE System

Gres porcellanato smaltato ingelivo Frost-resistant glazed porcelain stoneware Glasiertes und frostbeständiges Feinsteinzeug Grès cérame émaillé ingélif

IG

IG Grip R11 C (A+B+C)
Superficie antiscivolo satinata
Satin-finish non-slip surface
Satinierete, rutschfeste Oberfläche
Surface anti-dérapante satinée

pavimento
Floor tiling
Bodenbelag
Revêtement de sol

5x5 cm
10x10 cm
20x20 cm
Pezzi Speciali



RF

RF Flooring R10 B (A+B)
Superficie antiscivolo satinata
Satin-finish non-slip surface
Satinierete, rutschfeste Oberfläche
Surface anti-dérapante satinée

pavimento
Floor tiling
Bodenbelag
Revêtement de sol

5x5 cm
10x10 cm
20x20 cm
20x40 cm



TR

TR Trasparenze
Superficie lucida
Glossy surface
Glänzende Oberfläche
Surface lustrée

rivestimento
Wall tiling
Wandfliesen
Revêtement de mur

5x5 cm
5x20 cm
10x10 cm
10x20 cm
20x20 cm
20x40 cm
Bisello 10x10 cm
Bisello 10x20 cm
Pezzi Speciali

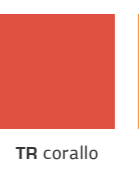
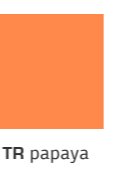
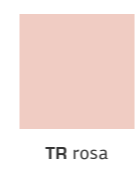
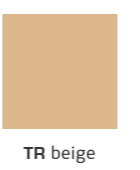
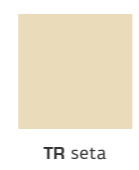

IN

IN Interni
Superficie satinata
Satin-finish surface
Satinierete Oberfläche
Surface satinée

pavimento e rivestimento
Wall and floor tiling
Bodenbelag und Wandverkleidung
Revêtement de sol et de mur

5x5 cm
5x20 cm
5x40 cm
10x10 cm
10x20 cm
20x20 cm
20x40 cm
Bisello 10x10 cm
Bisello 10x20 cm
Pezzi Speciali

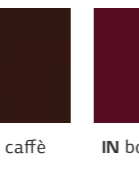
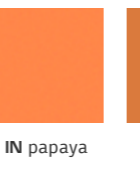
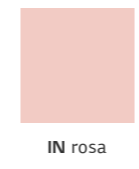

VOGUE Link

Gres porcellanato smaltato ingelivo Frost-resistant glazed porcelain stoneware Glasiertes und frostbeständiges Feinsteinzeug Grès cérame émaillé ingélif

M IN/M TR

M IN/M TR IN Mix/TR Mix
Superficie satinata/lucida
Satin-finish/glossy surface
Satinierete/glänzende Oberfläche
Surface satinée/lustrée

Pavimento e rivestimento
Wall and floor
Bodenbelag und Wandverkleidung
Revêtement de sol et de mur

(5x5 cm)
30x30 cm
montato su fibra di vetro

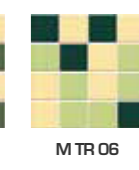
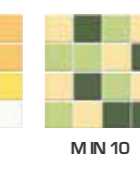
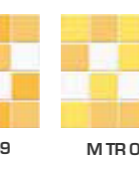
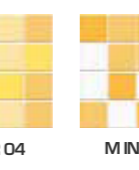
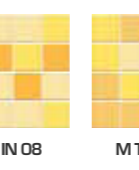
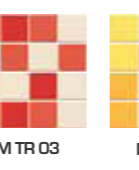
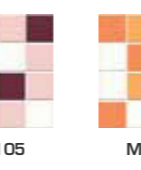
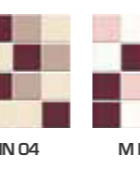
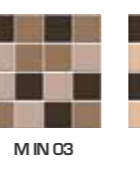

M RF/M IG

M RF/M IG RF Mix/IG Mix
Superficie antiscivolo satinata
Satin-finish non-slip surface
Satinierete, rutschfeste Oberfläche
Surface anti-dérapante satinée

pavimento
Floor tiling
Bodenbelag
Revêtement de sol

(5x5 cm)
30x30 cm
montato su fibra di vetro

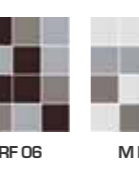
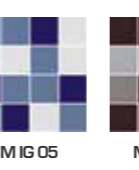
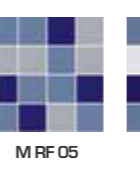
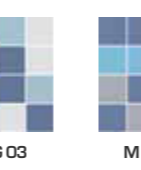
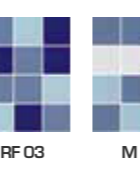
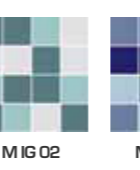
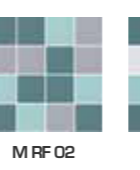

VOGUE Floor

Gres porcellanato smaltato ingelivo Frost-resistant glazed porcelain stoneware Glasiertes und frostbeständiges Feinsteinzeug Grès cérame émaillé ingélif

IN/RF

IN/RF Interni40/Flooring40 R10
Superficie satinata/antiscivolo
Satin-finish/non-slip surface
Satinierete/rutschfeste Oberfläche
Surface satinée/anti-dérapante

pavimento
Floor tiling
Bodenbelag
Revêtement de sol

40x40 cm
Battiscopa
9,5x40 cm

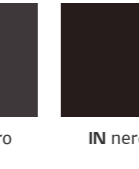
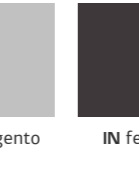
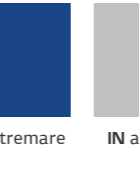
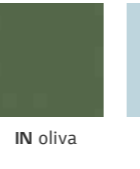
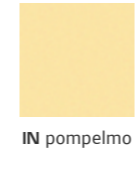
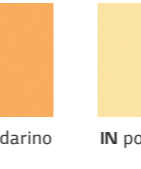

IG

IG Grip40 B (A+B)
Superficie antiscivolo satinata
Satin-finish non-slip surface
Satinierete, rutschfeste Oberfläche
Surface anti-dérapante satinée

pavimento
Floor tiling
Bodenbelag
Revêtement de sol

40x40 cm
Battiscopa
9,5x40 cm

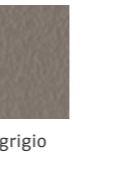
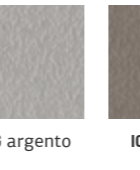

VOGUE Pool

Gres porcellanato smaltato ingelivo Frost-resistant glazed porcelain stoneware Glasiertes und frostbeständiges Feinsteinzeug Grès cérame émaillé ingélif

BP

BP Bump C (A+B+C) V6
Superficie antiscivolo strutturata
Structured skid resistant surface
Rutschfeste strukturierte Oberfläche
Surface antidérapante structurée

pavimento
Floor tiling
Bodenbelag
Revêtement de sol

10x20 cm
Special Pool

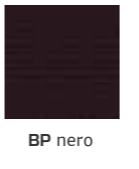
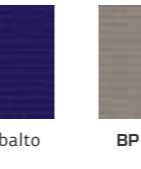
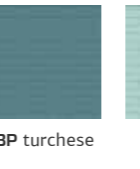

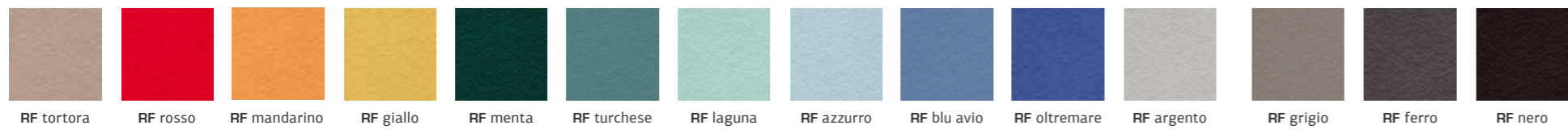
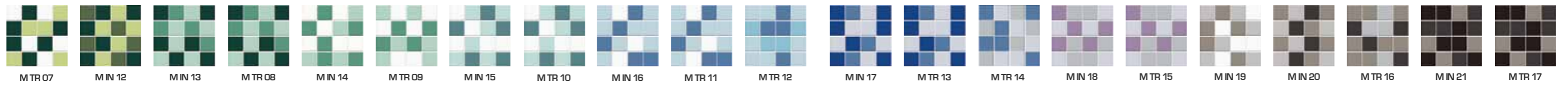
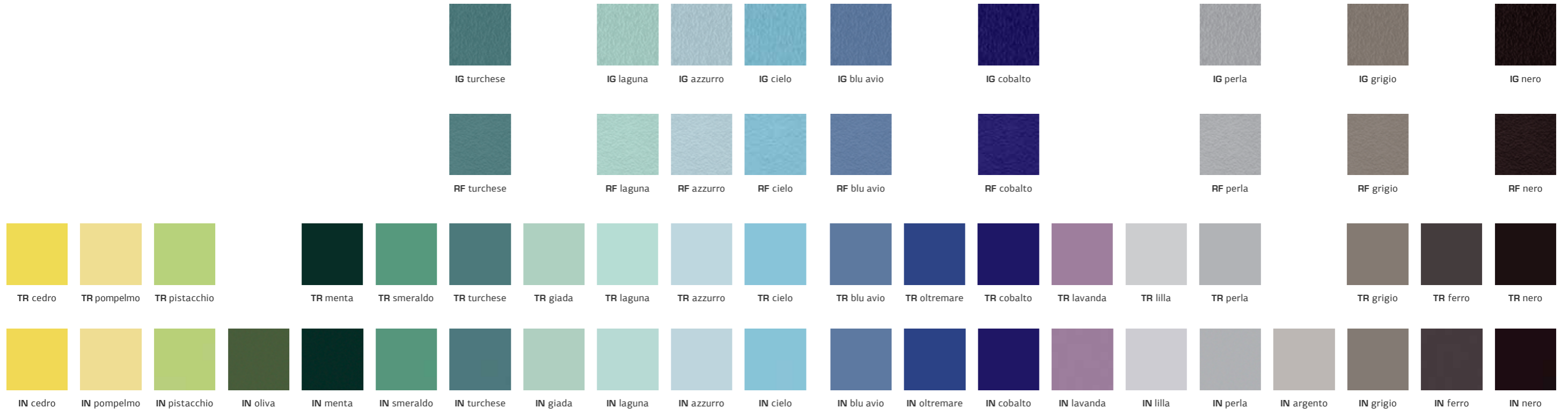

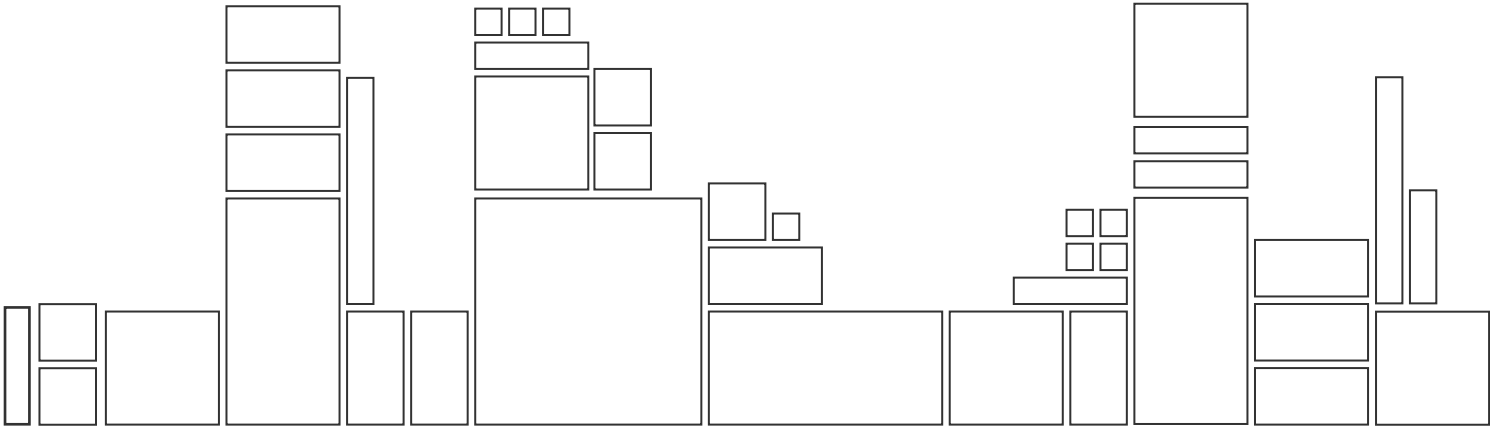

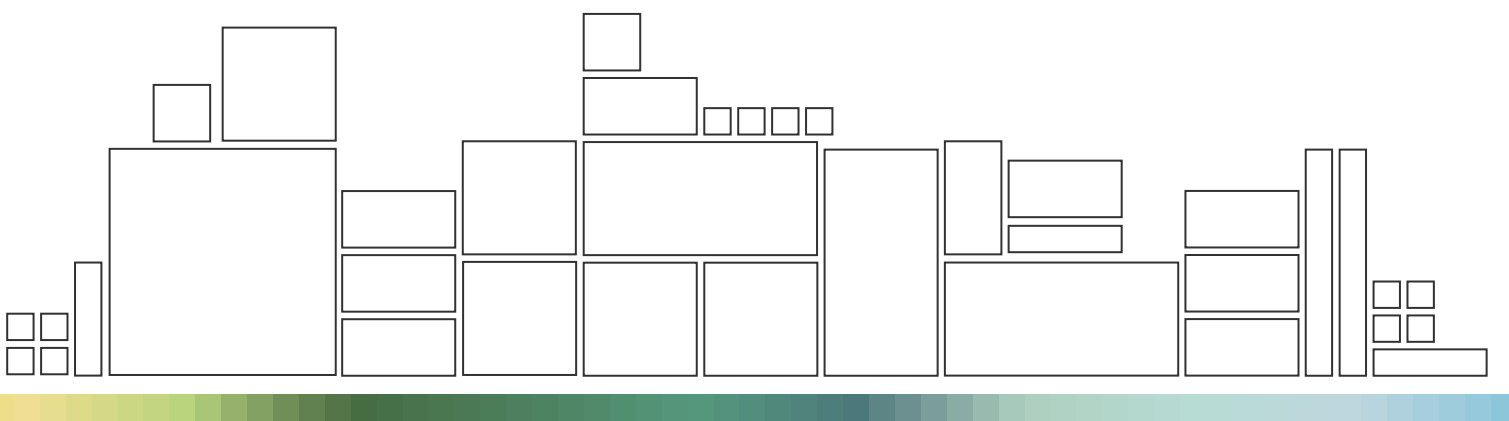

VOGUE System

Interni

Trasparenze

Flooring R10 B (A+B)

Grip R11 C (A+B+C)

Cos'è Vogue System

Ceramica Vogue ha ideato Vogue System, innovativo sistema ceramico pensato per ogni tipo di ambiente, in grado di soddisfare le esigenze progettuali di architetti e interior designer. Più finiture nelle medesime tonalità di un'ampia gamma cromatica declinate su 3 moduli base quadrati e 4 moduli base rettangolari, si propongono come soluzione ideale per arredare spazi residenziali e commerciali, per rivestimenti esterni e per esigenze specifiche ove sia richiesto un prodotto antiscivolo.

What is Vogue System

Ceramica Vogue has created Vogue System, an innovative ceramic system designed for all types of settings, able to satisfy the design requirements of architects and interior designers. Several finishes in the same shades of a wide range of colours in 3 square base modules and 4 rectangular base modules, are the ideal solution for tiling residential and commercial settings, for external wall tiling and specific needs which require non-slip products.

Was ist Vogue System

Ceramica Vogue hat sich das Vogue System ausgedacht, ein innovatives keramisches System für jede Art von Umfeld, das den gestalterischen Anforderungen von Architekten und Innenarchitekten in jeder Hinsicht gerecht wird. Weitere Oberflächenausführungen in den gleichen Farbtönen mit großer Auswahl, 3 quadratischen und 4 rechteckigen Basismodulen, sind eine ideale Lösung für die Gestaltung von Wohn- und Gewerbeflächen, für die Verkleidung von Außenflächen und spezifische Bedürfnisse, die rutschhemmenden Oberflächen verlangen.

Qu'est-ce que Vogue System

Ceramica Vogue a conçu Vogue System, un système céramique novateur réalisé pour tous les types d'environnements, en mesure de satisfaire les exigences conceptuelles des architectes et des designers d'intérieur. Davantage de finitions dans les mêmes tonalités d'une vaste gamme chromatique, déclinées sur 3 modules de base carrés et 4 modules de base rectangulaires, se proposent comme une solution idéale pour décorer les espaces résidentiels et commerciaux, pour les revêtements externes et pour les exigences spécifiques là où est requis un produit anti-dérapant.

Grip R11 C (A+B+C)

Piacevolmente materica, la superficie di Grip garantisce massima aderenza e sicurezza in ambienti bagnati - R11 C (A+B+C) - rispondendo alle normative vigenti in termini di antiscivolosità. A corredo sono disponibili i pezzi speciali, soluzione ideale per spazi pubblici quali piscine e fitness center.

Pleasing and earthy, the non-slip surface assures grip and safety in wet areas - R11 C (A+B+C) - responding to the applicable non-slip regulations. The range comes with special pieces, the ideal solution for public areas including swimming pools and fitness centers.

Ein angenehmes Material, die Oberfläche Grip sorgt für maximale Haftung und Sicherheit bei Nässe - R11 C (A+B+C) - sie entspricht den geltenden Vorschriften in Bezug auf Rutschfestigkeit und Trittsicherheit. Dazu passend gibt es die Formteile, eine ideale Lösung für öffentliche Bereiche wie Schwimmbäder und Fitnesscenter.

Agréablement matériériste, la surface de Grip garantit l'adhérence et la sécurité maximales dans les environnements mouillés - R11 C (A+B+C) - en répondant aux normes en vigueur en termes d'anti-glissance. Il existe également, en assortiment, les pièces spéciales, solution idéale pour les espaces publics tels que les piscines et les centres de fitness.

Flooring R10 B (A+B)

Flooring è la collezione per pavimenti adatta a rispondere alle normative vigenti e alle esigenze pratiche in materia di antiscivolosità in ambienti asciutti/umidi - R10 B (A+B). La superficie ruvida garantisce buona aderenza senza tuttavia trascurare l'attenzione all'estetica e la pulibilità.

Flooring is the floor tile collection which complies with the applicable standards in force and the practical demands for non-slip surfaces in dry and damp settings - R10 B (A+B). The rough surface offers good grip without compromising on attractiveness and cleanability.

Flooring ist die Kollektion für Bodenbeläge, die vollständig den geltenden Vorschriften und praktischen Anforderungen im Hinblick auf Rutschfestigkeit und Trittsicherheit in trockenen und feuchten Räumen - R10 B (A+B) entspricht. Die raue Oberfläche bietet eine gute Haftung, ohne dabei auf Ästhetik und Pflegeleichtigkeit zu verzichten.

Flooring est la collection pour revêtements de sols, adaptée à répondre aux normes en vigueur et aux exigences pratiques en matière d'anti-glissance dans les environnements secs/humides - R10 B (A+B). La surface rugueuse garantit une bonne adhérence, sans toutefois réduire l'attention portée à l'esthétique et à la facilité de nettoyage.

Trasparenze

Lucida e brillante, Trasparenze è pensata per rivestimenti di spazi pubblici e privati contraddistinti da gusto ed eleganza. Le finiture del Vogue System si prestano a completare la pavimentazione di ogni ambiente arredato da Trasparenze.

Glossy and shiny, Trasparenze is designed for tiling elegant and tasteful public and private spaces. The Vogue System finishes are used to complete the flooring in any setting tiled with Trasparenze.

Die hochglänzende Oberfläche der Serie Trasparenze ist für öffentliche und private Räume bestimmt, die sich durch Geschmack und Eleganz auszeichnen. Die Oberflächenausführungen von Vogue System vervollständigen die Bodenbeläge in jedem Raum, der mit Trasparenze gestaltet ist.

Lustrée et brillante, Trasparenze est conçue pour les revêtements d'espaces publics et privés caractérisés par le goût et l'élégance. Les finitions du Vogue System sont adaptées pour compléter le revêtement de chaque environnement utilisant Trasparenze.

Interni

Estremamente versatile grazie all'ampia scelta di formati modulari corredati di tozzetti e pezzi speciali, Interni può essere abbinata alle altre finiture del Vogue System per arredare interni ed esterni di ambienti pubblici e residenziali.

The wide range of modular sizes, insets and special pieces make Interni extremely versatile. It can be combined with the other Vogue System finishes to tile public and residential interiors and exteriors.

Die Serie Interni ist extrem vielseitig, dank der großen Auswahl an zusammenstellbaren Formaten mit Einlegern und Formteilen, und kann mit den anderen Ausführungen des Vogue Systems kombiniert werden, um Außen- und Innenbereiche öffentlicher und privater Bereiche zu gestalten.

Extrêmement versatile grâce au vaste choix de formats modulaires accompagnés de cabochons et de pièces spéciales, Interni peut être assortie aux autres finitions du Vogue System pour revêtir les intérieurs et les extérieurs d'environnements publics et résidentiels.

IN TR RF IG

ghiaccio	latte	seta	beige	nociola	tortora	rosa	albicocca	papaya	arancio	caffè	bordeaux	rosso	corallo	mandarino	girasole	giallo	cedro	pompelmo
RAL 9003	RAL 9010	RAL 1015	RAL 1001	RAL 8025	RAL 1019	RAL 040 80 10	RAL 1034	RAL 050 70 60	RAL 8023	RAL 050 20 10	RAL 3005	RAL 3020	RAL 2012	RAL 1034	RAL 075 70 70	RAL 1002	RAL 1018	RAL 090 80 30
pag. 26	pag. 28	pag. 30	pag. 32	pag. 34	pag. 36	pag. 38	pag. 40	pag. 42	pag. 44	pag. 46	pag. 48	pag. 50	pag. 52	pag. 54	pag. 56	pag. 58	pag. 60	pag. 62

Utilizzo: interni ed esterni, pavimenti e rivestimenti

Use: internal and external, floor and wall tiling

Einsatzbereich: Innen- und Außenbereiche, Bodenbeläge und Wandverkleidungen

Utilisation: intérieurs et extérieurs, revêtements de sols et de murs

Utilizzo: interni ed esterni, rivestimento

Use: internal and external, wall tiling

Einsatzbereich: Innen- und Außenbereiche, Wandverkleidung

Utilisation: intérieurs et extérieurs, revêtements de murs

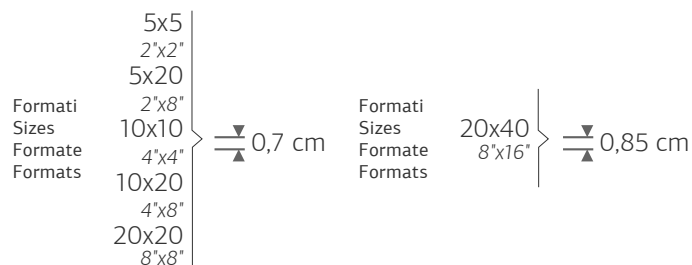
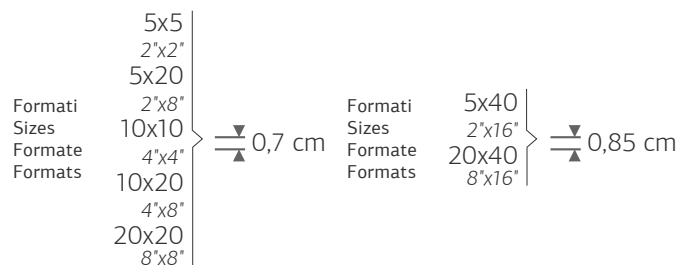

IN - Interni

TR - trasparenze



pistacchio	oliva	menta	smeraldo	turchese	giada	laguna	azzurro	cielo	blu avio	oltremare	cobalto	lavanda	lilla	perla	argento	grigio	ferro	nero
RAL 110 80 30	RAL 120 40 20	RAL 60 28	RAL 160 60 25	RAL 60 34	RAL 160 80 10	RAL 180 80 10	RAL 220 80 10	RAL 230 70 20	RAL 50 14	RAL 50 05	RAL 50 22	RAL 40 09	RAL 70 47	RAL 70 04	RAL 70 44	RAL 70 06	RAL 80 19	RAL 90 04
pag. 64	pag. 66	pag. 68	pag. 70	pag. 72	pag. 74	pag. 76	pag. 78	pag. 80	pag. 82	pag. 84	pag. 86	pag. 88	pag. 90	pag. 92	pag. 94	pag. 96	pag. 98	pag. 100

Utilizzo: interni ed esterni, pavimenti umidi - R10 B (A+B)

Use: internal and external, damp floors - R10 B (A+B)

Einsatzbereich: Innen- und Außenbereiche, feuchte Bodenbeläge - R10 B (A+B)

Utilisation: intérieurs et extérieurs, revêtements de sols humides - R10 B (A+B)

Utilizzo: interni ed esterni, pavimenti bagnati - R11 C (A+B+C)

Use: internal and external, wet floors - R11 C (A+B+C)

Einsatzbereich: Innen- und Außenbereiche, nasse Bodenbeläge - R11 C (A+B+C)

Utilisation: intérieurs et extérieurs, revêtements de sols mouillés - R11 C (A+B+C)

Formati Sizes Formate Formats	5x5	} $\frac{\nabla}{\blacktriangle}$ 0,7 cm	Formati Sizes Formate Formats	20x40	} $\frac{\nabla}{\blacktriangle}$ 0,85 cm	
	2"x2"					8"x16"
	10x10					
	4"x4"					
	20x20					
8"x8"						

Formati Sizes Formate Formats	5x5	} $\frac{\nabla}{\blacktriangle}$ 0,7 cm
	2"x2"	
	10x10	
	4"x4"	
	20x20	
8"x8"		

RF - Flooring R10 B (A+B)

IG - Grip R11 C (A+B+C)

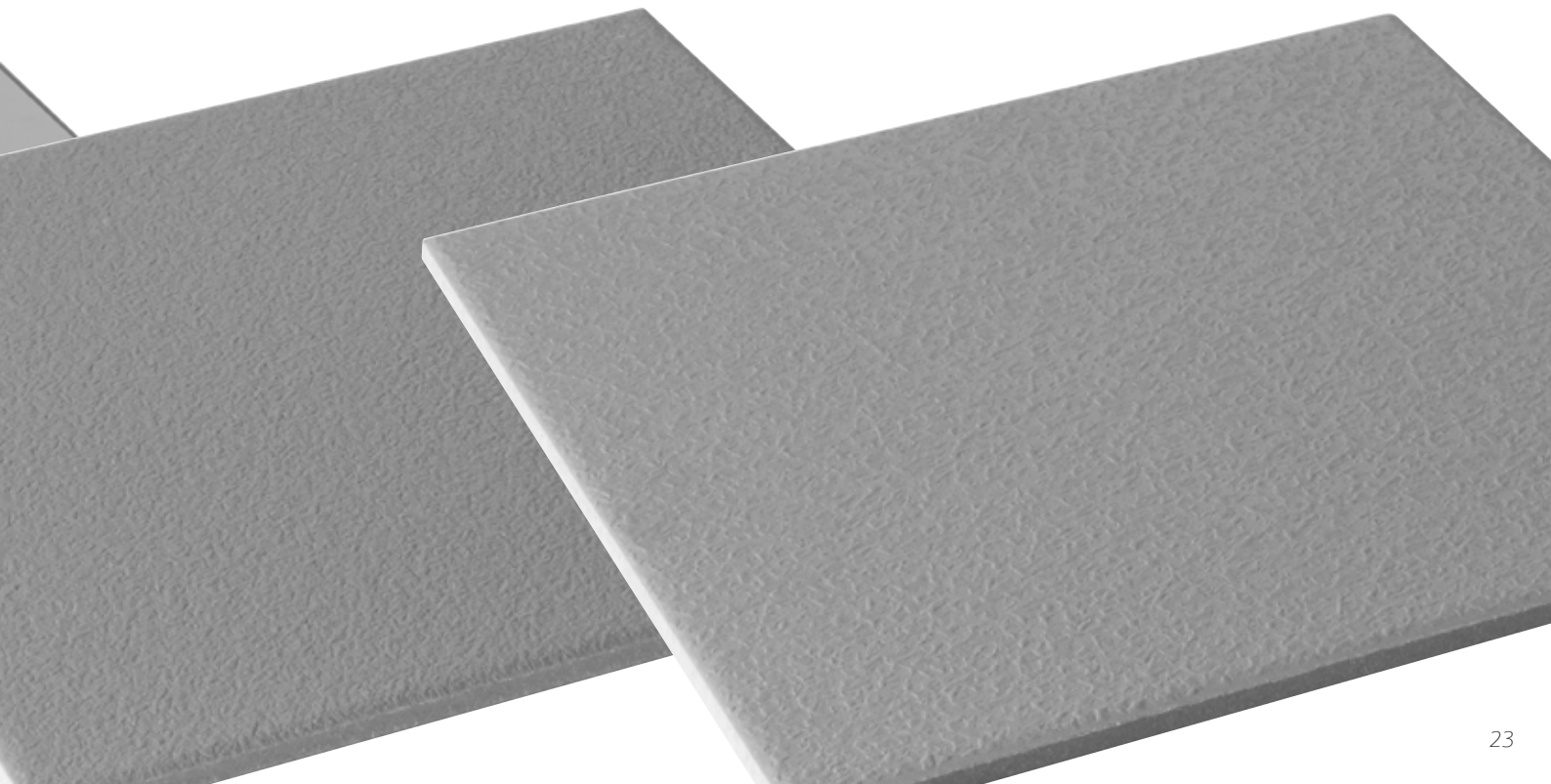

Pezzi speciali

Una completa gamma di pezzi speciali, disponibili in tutti i colori del Vogue System, risponde a ogni esigenza di progettazione, dalle necessità tecniche a quelle imposte dalle attuali normative in materia di igiene e manutenzione. I pezzi speciali sono disponibili nelle finiture Interni satinata e trasparenze lucida e hanno dimensioni modulari ai formati del Vogue System. Per un più dettagliato elenco si rimanda alle schede dei singoli prodotti.

Special pieces

A complete range of special pieces, available in all the colours of the Vogue System, responds to all design needs, from technical requirements to the demand for compliance with hygiene and maintenance standards. The special pieces are available in satin-finished Interni and glossy trasparenze and come in the modular sizes of the Vogue System. For a detailed list please refer to the individual product sheets.

Formteile

Eine vollständige Auswahl an Formteilen, die in allen Farben des Vogue Systems erhältlich sind, entspricht allen Erfordernissen, von den technischen Anforderungen bis zu den geltenden Vorschriften zu Hygiene und Wartung. Die Formteile sind in den Ausführungen satiniert (Interni) und glänzend (Trasparenze) erhältlich. Die Formate sind mit den Formaten des Vogue Systems kompatibel. Eine detaillierte Liste finden Sie jeweils bei den einzelnen Produkten.

Pièces spéciales

Une gamme complète de pièces spéciales, disponibles dans toutes les couleurs du Vogue System, répond à toutes les exigences conceptuelles, depuis les nécessités techniques jusqu'à celles imposées par les normes actuelles en matière d'hygiène et d'entretien. Les pièces spéciales sont disponibles dans les finitions Interni satinée et trasparenze brillante et présentent des dimensions s'adaptant aux formats du Vogue System. Pour une liste plus détaillée, nous renvoyons aux fiches de chacun des produits.

Interni *superficie satinata satin-finish surface satinierte Oberfläche surface satinée*



Cod. M
2,5x20 cm
1"x8"



Cod. N
2,5x20 cm
1"x8"



Cod. W
2,5x10 cm
1"x4"



Cod. K
2,5x10 cm
1"x4"



Cod. G
2,5x10 cm
1"x4"



Cod. H
2,5x10 cm
1"x4"



Cod. C
2,5x2,5 cm
1"x1"



Cod. D
2,5x2,5 cm
1"x1"



Cod. E
2,5x2,5 cm
1"x1"



Cod. F
2,5x2,5 cm
1"x1"



Cod. U
10x10 cm
4"x4"



Cod. Z
10x10 cm
4"x4"



Cod. X
10x20 cm
4"x8"



Cod. I
10x20 cm
4"x8"

Trasparenze *superficie lucida glossy surface glänzende Oberfläche surface lustrée*



Cod. M
2,5x20 cm
1"x8"



Cod. N
2,5x20 cm
1"x8"



Cod. W
2,5x10 cm
1"x4"



Cod. K
2,5x10 cm
1"x4"



Cod. C
2,5x2,5 cm
1"x1"



Cod. D
2,5x2,5 cm
1"x1"



Cod. E
2,5x2,5 cm
1"x1"



Cod. F
2,5x2,5 cm
1"x1"

Grip *superficie antiscivolo satinata satin-finish non-slip surface satinierte, rutschfeste Oberfläche surface anti-dérapante satinée*



Bordo Cod. B
10x10 cm
4"x4"



Angolo Cod. I
10x10 cm
4"x4"



Spigolo Cod. E
10x10 cm
4"x4"

Grip R11 C (A+B+C) *superficie antiscivolo satinata satin-finish non-slip surface satinierte, rutschfeste Oberfläche surface anti-dérapante satinée*

Utilizzo: interni ed esterni, pavimenti - R11 C (A+B+C)
 Use: internal and external, floors - R11 C (A+B+C)
 Einsatzbereich: Innen- und Außenbereiche, Bodenbeläge - R11 C (A+B+C)
 Utilisation: intérieurs et extérieurs, revêtements de sols - R11 C (A+B+C)

I formati 10x10 e 5x5 sono anche disponibili montati su rete in fibra di vetro
 The 10x10 and 5x5 sizes are also available mounted on a fibreglass mesh support
 Die Formate 10x10 und 5x5 sind auch auf Glasfasernetz montiert erhältlich
 Les formats 10x10 et 5x5 existent aussi montés sur filets en fibre de verre

Formati	5x5	} $\frac{\nabla}{\triangle} 0,7 \text{ cm}$
Sizes	2'x2"	
Formate	10x10	
Formats	4'x4"	
	20x20 8'x8"	

Flooring R10 B (A+B) *superficie antiscivolo satinata satin-finish non-slip surface satinierte, rutschfeste Oberfläche surface anti-dérapante satinée*

Utilizzo: interni ed esterni, pavimenti - R10 B (A+B)
 Use: internal and external, floors - R10 B (A+B)
 Einsatzbereich: Innen- und Außenbereiche, Bodenbeläge - R10 B (A+B)
 Utilisation: intérieurs et extérieurs, revêtements de sols - R10 B (A+B)

I formati 10x10 e 5x5 sono anche disponibili montati su rete in fibra di vetro
 The 10x10 and 5x5 sizes are also available mounted on a fibreglass mesh support
 Die Formate 10x10 und 5x5 sind auch auf Glasfasernetz montiert erhältlich
 Les formats 10x10 et 5x5 existent aussi montés sur filets en fibre de verre

Formati	5x5	} $\frac{\nabla}{\triangle} 0,7 \text{ cm}$	Formati	20x40	} $\frac{\nabla}{\triangle} 0,85 \text{ cm}$
Sizes	2'x2"		Sizes	8'x16"	
Formate	10x10		Formate		
Formats	4'x4"		Formats		
	20x20 8'x8"				

Trasparenze *superficie lucida glossy surface glänzende Oberfläche surface lustrée*

Utilizzo: interni ed esterni, rivestimento
 Use: internal and external, wall tiling
 Einsatzbereich: Innen- und Außenbereiche, Wandverkleidung
 Utilisation: intérieurs et extérieurs, revêtements de murs

I formati 10x10, 5x5 e 5x20 sono anche disponibili montati su rete in fibra di vetro
 The 10x10, 5x5 and 5x20 sizes are also available mounted on a fibreglass mesh support
 Die Formate 10x10, 5x5 und 5x20 sind auch auf Glasfasernetz montiert erhältlich
 Les formats 10x10, 5x5 et 5x20 existent aussi montés sur filets en fibre de verre

Formati	5x5	} $\frac{\nabla}{\triangle} 0,7 \text{ cm}$	Formati	20x40	} $\frac{\nabla}{\triangle} 0,85 \text{ cm}$
Sizes	2'x2"		Sizes	8'x16"	
Formate	5x20		Formate		
Formats	2'x8"		Formats		
	10x10 4'x4"				
	10x20 4'x8"				
	20x20 8'x8"				

Bisello

10x10
4'x4"
10x20
4'x8"

0,7 cm  0,85 cm

Utilizzo: interni, rivestimento
 Use: interiors, wall tiling
 Einsatzbereich: Innenräume, Wandverkleidung
 Utilisation: intérieurs, revêtements de murs

Non ingelivo - Not frost resistant - Nicht Frostbeständig - Gélif

Interni *superficie satinata satin-finish surface satinierte Oberfläche surface satinée*

Utilizzo: interni ed esterni, pavimenti e rivestimenti
 Use: internal and external, floor and wall tiling
 Einsatzbereich: Innen- und Außenbereiche, Bodenbeläge und Wandverkleidungen
 Utilisation: intérieurs et extérieurs, revêtements de sols et de murs

I formati 10x10, 5x5, 5x40 e 5x20 sono anche disponibili montati su rete in fibra di vetro
 The 10x10, 5x5, 5x40 and 5x20 sizes are also available mounted on a fibreglass mesh support
 Die Formate 10x10, 5x5, 5x40 und 5x20 sind auch auf Glasfasernetz montiert erhältlich
 Les formats 10x10, 5x5, 5x40 et 5x20 existent aussi montés sur filets en fibre de verre

Formati	5x5	} $\frac{\nabla}{\triangle} 0,7 \text{ cm}$	Formati	5x40	} $\frac{\nabla}{\triangle} 0,85 \text{ cm}$
Sizes	2'x2"		Sizes	2'x16"	
Formate	5x20		Formate	20x40	
Formats	2'x8"		Formats	8'x16"	
	10x10 4'x4"				
	10x20 4'x8"				
	20x20 8'x8"				

Bisello

10x10
4'x4"

0,7 cm  0,85 cm

Utilizzo: interni, rivestimento
 Use: interiors, wall tiling
 Einsatzbereich: Innenräume, Wandverkleidung
 Utilisation: intérieurs, revêtements de murs

Non ingelivo - Not frost resistant - Nicht Frostbeständig - Gélif

5x5 cm



10x10 cm



20x20 cm



P.E.I. ④

IG



Bordo Cod. B
10x10 cm

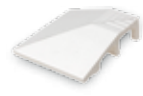

Angolo Cod. I
10x10 cm



Spigolo Cod. E
10x10 cm

5x5 cm



10x10 cm



20x20 cm



20x40 cm



P.E.I. ④

RF

5x5 cm



10x10 cm



Bisello
10x10 cm



20x20 cm

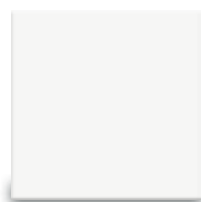

20x40 cm

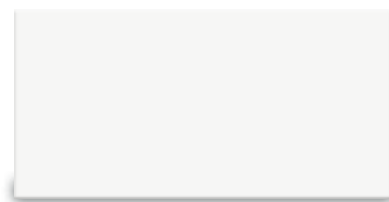

10x20 cm

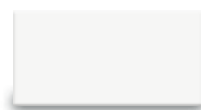

Bisello
10x20 cm

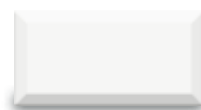

5x20 cm



P.E.I. ④

TR



Stick
1,2x20 cm



Cod. M
2,5x20 cm



Cod. N
2,5x20 cm



Cod. W
2,5x10 cm



Cod. K
2,5x10 cm



Cod. E
2,5x2,5 cm



Cod. F
2,5x2,5 cm



Cod. C
2,5x2,5 cm



Cod. D
2,5x2,5 cm

5x5 cm



10x10 cm



Bisello
10x10 cm



20x20 cm



20x40 cm

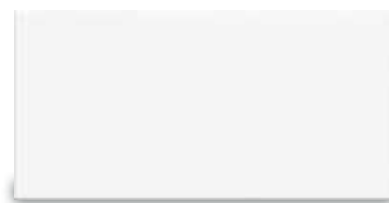

10x20 cm

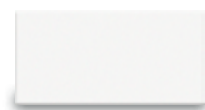

5x20 cm

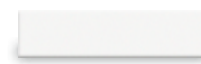

5x40 cm

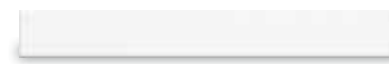

P.E.I. ④

IN



Quadra
2,5x20 cm



Stick
1,2x20 cm



Cod. M
2,5x20 cm



Cod. N
2,5x20 cm



Cod. W
2,5x10 cm



Cod. K
2,5x10 cm



Cod. G
2,5x10 cm



Cod. H
2,5x10 cm



Cod. E
2,5x2,5 cm



Cod. F
2,5x2,5 cm



Cod. C
2,5x2,5 cm



Cod. D
2,5x2,5 cm



Cod. U
10x10 cm



Cod. Z
10x10 cm



Cod. X
10x20 cm



Cod. I
10x20 cm

5x5 cm



10x10 cm



20x20 cm

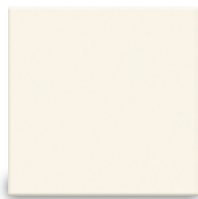

20x40 cm

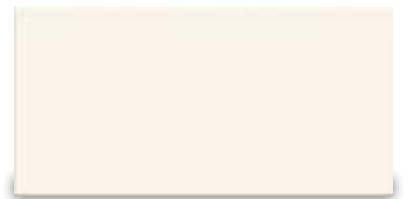

Quadra
2,5x20 cm



Stick
1,2x20 cm



Cod. M
2,5x20 cm



Cod. N
2,5x20 cm



Cod. W
2,5x10 cm



Cod. K
2,5x10 cm



Cod. G
2,5x10 cm



Cod. H
2,5x10 cm



Cod. E
2,5x2,5 cm



Cod. F
2,5x2,5 cm

IG

RF

TR

IN

10x20 cm

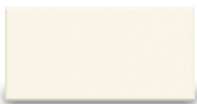

5x20 cm

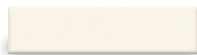

5x40 cm

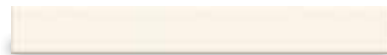

P.E.I. ④



Cod. C
2,5x2,5 cm



Cod. D
2,5x2,5 cm



Cod. U
10x10 cm



Cod. Z
10x10 cm



Cod. X
10x20 cm



Cod. I
10x20 cm

5x5 cm



10x10 cm



20x20 cm



Bordo Cod. B
10x10 cm



Angolo Cod. I
10x10 cm



Spigolo Cod. E
10x10 cm

5x5 cm



10x10 cm



20x20 cm



20x40 cm



5x5 cm



10x10 cm



Bisello
10x10 cm



20x20 cm

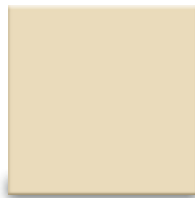

20x40 cm

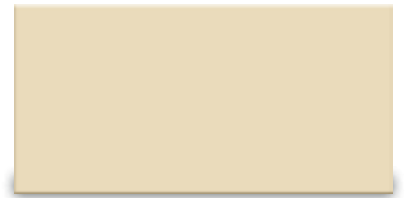

Stick
1,2x20 cm



Cod. M
2,5x20 cm



Cod. N
2,5x20 cm



Cod. W
2,5x10 cm



Cod. K
2,5x10 cm



Cod. E
2,5x2,5 cm



Cod. F
2,5x2,5 cm

5x5 cm



10x10 cm



20x20 cm



20x40 cm

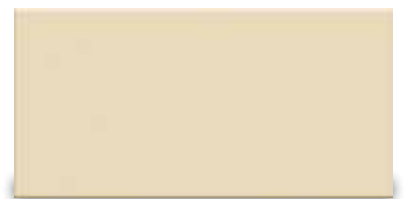

Quadra
2,5x20 cm



Stick
1,2x20 cm



Cod. M
2,5x20 cm



Cod. N
2,5x20 cm



Cod. W
2,5x10 cm



Cod. K
2,5x10 cm



Cod. G
2,5x10 cm



Cod. H
2,5x10 cm



Cod. E
2,5x2,5 cm



Cod. F
2,5x2,5 cm

P.E.I. ④

IG

P.E.I. ④

RF

P.E.I. ③

TR

P.E.I. ④

IN

10x20 cm

Bisello
10x20 cm

5x20 cm

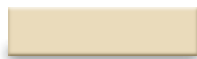



Cod. C
2,5x2,5 cm

Cod. D
2,5x2,5 cm

10x20 cm

5x20 cm

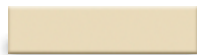
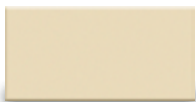
5x40 cm



Cod. C
2,5x2,5 cm

Cod. D
2,5x2,5 cm

Cod. U
10x10 cm

Cod. Z
10x10 cm

Cod. X
10x20 cm

Cod. I
10x20 cm

5x5 cm



10x10 cm



20x20 cm

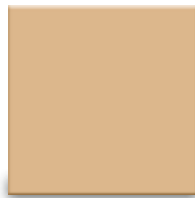

20x40 cm

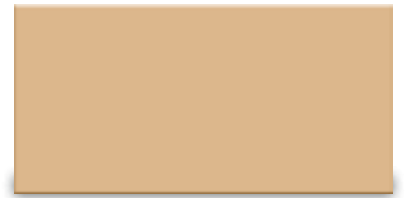

Stick
1,2x20 cm



Cod. M
2,5x20 cm



Cod. N
2,5x20 cm



Cod. W
2,5x10 cm



Cod. K
2,5x10 cm



Cod. E
2,5x2,5 cm



Cod. F
2,5x2,5 cm

5x5 cm



10x10 cm



20x20 cm



20x40 cm

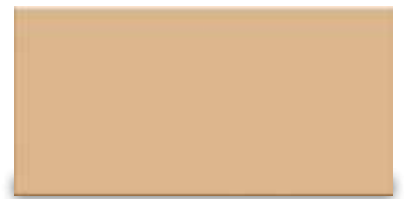

Quadra
2,5x20 cm



Stick
1,2x20 cm



Cod. M
2,5x20 cm



Cod. N
2,5x20 cm



Cod. W
2,5x10 cm



Cod. K
2,5x10 cm



Cod. G
2,5x10 cm



Cod. H
2,5x10 cm



Cod. E
2,5x2,5 cm



Cod. F
2,5x2,5 cm

IG

RF

TR

IN

10x20 cm

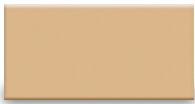

5x20 cm



P.E.I. ③



Cod. C
2,5x2,5 cm



Cod. D
2,5x2,5 cm

10x20 cm

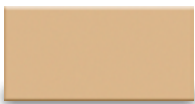

5x20 cm



5x40 cm



P.E.I. ④



Cod. C
2,5x2,5 cm



Cod. D
2,5x2,5 cm



Cod. U
10x10 cm



Cod. Z
10x10 cm



Cod. X
10x20 cm



Cod. I
10x20 cm

5x5 cm



10x10 cm



20x20 cm



20x40 cm



Quadra
2,5x20 cm



Stick
1,2x20 cm



Cod. M
2,5x20 cm



Cod. N
2,5x20 cm



Cod. W
2,5x10 cm



Cod. K
2,5x10 cm



Cod. G
2,5x10 cm



Cod. H
2,5x10 cm



Cod. E
2,5x2,5 cm



Cod. F
2,5x2,5 cm

IG

RF

TR

P.E.I. ② IN

10x20 cm



5x20 cm



5x40 cm



Cod. C
2,5x2,5 cm

Cod. D
2,5x2,5 cm

Cod. U
10x10 cm

Cod. Z
10x10 cm

Cod. X
10x20 cm

Cod. I
10x20 cm

5x5 cm



10x10 cm



20x20 cm



20x40 cm



Quadra
2,5x20 cm



Stick
1,2x20 cm



Cod. M
2,5x20 cm



Cod. N
2,5x20 cm



Cod. W
2,5x10 cm



Cod. K
2,5x10 cm



Cod. G
2,5x10 cm



Cod. H
2,5x10 cm



Cod. E
2,5x2,5 cm



Cod. F
2,5x2,5 cm

IG

RF

TR

Bisello
10x20 cm



10x20 cm

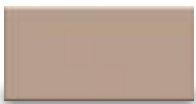

5x20 cm



5x40 cm



P.E.I. ③

IN

Cod. C
2,5x2,5 cm



Cod. D
2,5x2,5 cm



Cod. U
10x10 cm



Cod. Z
10x10 cm



Cod. X
10x20 cm



Cod. I
10x20 cm



5x5 cm



10x10 cm



20x20 cm



20x40 cm



Stick
1,2x20 cm



Cod. M
2,5x20 cm



Cod. N
2,5x20 cm



Cod. W
2,5x10 cm



Cod. K
2,5x10 cm



Cod. E
2,5x2,5 cm



Cod. F
2,5x2,5 cm

5x5 cm



10x10 cm



20x20 cm



20x40 cm

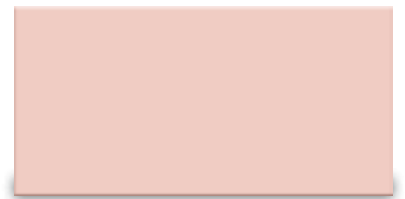

Quadra
2,5x20 cm



Stick
1,2x20 cm



Cod. M
2,5x20 cm



Cod. N
2,5x20 cm



Cod. W
2,5x10 cm



Cod. K
2,5x10 cm



Cod. G
2,5x10 cm



Cod. H
2,5x10 cm



Cod. E
2,5x2,5 cm



Cod. F
2,5x2,5 cm

IG

RF

TR

IN

P.E.I. ③

P.E.I. ④

10x20 cm

Bisello
10x20 cm

5x20 cm

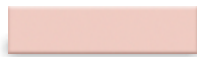



Cod. C
2,5x2,5 cm

Cod. D
2,5x2,5 cm

10x20 cm

5x20 cm

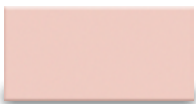
5x40 cm



Cod. C
2,5x2,5 cm

Cod. D
2,5x2,5 cm

Cod. U
10x10 cm

Cod. Z
10x10 cm

Cod. X
10x20 cm

Cod. I
10x20 cm

5x5 cm



10x10 cm



20x20 cm



20x40 cm

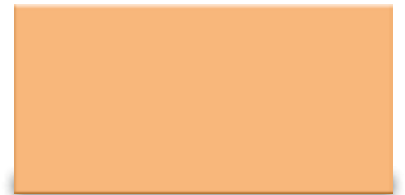

Stick
1,2x20 cm



Cod. M
2,5x20 cm



Cod. N
2,5x20 cm



Cod. W
2,5x10 cm



Cod. K
2,5x10 cm



Cod. E
2,5x2,5 cm



Cod. F
2,5x2,5 cm

5x5 cm



10x10 cm

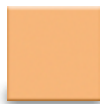

20x20 cm



20x40 cm

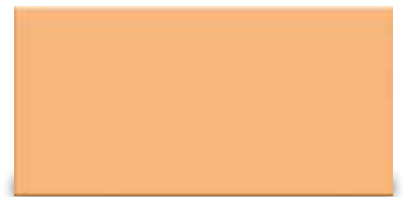

Quadra
2,5x20 cm



Stick
1,2x20 cm



Cod. M
2,5x20 cm



Cod. N
2,5x20 cm



Cod. W
2,5x10 cm



Cod. K
2,5x10 cm



Cod. G
2,5x10 cm



Cod. H
2,5x10 cm



Cod. E
2,5x2,5 cm



Cod. F
2,5x2,5 cm

IG

RF

TR

IN

10x20 cm



5x20 cm



P.E.I. ②



Cod. C
2,5x2,5 cm



Cod. D
2,5x2,5 cm

10x20 cm

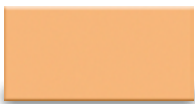

5x20 cm



5x40 cm



P.E.I. ③



Cod. C
2,5x2,5 cm



Cod. D
2,5x2,5 cm



Cod. U
10x10 cm



Cod. Z
10x10 cm



Cod. X
10x20 cm



Cod. I
10x20 cm

5x5 cm



10x10 cm



20x20 cm



20x40 cm



Stick
1,2x20 cm



Cod. M
2,5x20 cm



Cod. N
2,5x20 cm



Cod. W
2,5x10 cm



Cod. K
2,5x10 cm



Cod. E
2,5x2,5 cm



Cod. F
2,5x2,5 cm

5x5 cm



10x10 cm



20x20 cm



20x40 cm

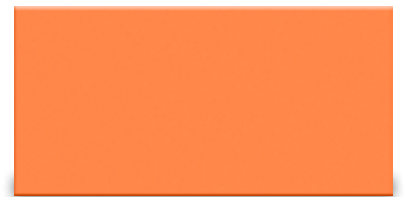

Quadra
2,5x20 cm



Stick
1,2x20 cm



Cod. M
2,5x20 cm



Cod. N
2,5x20 cm



Cod. W
2,5x10 cm



Cod. K
2,5x10 cm



Cod. G
2,5x10 cm



Cod. H
2,5x10 cm



Cod. E
2,5x2,5 cm



Cod. F
2,5x2,5 cm

IG

RF

TR

IN

10x20 cm



5x20 cm



P.E.I. ③



Cod. C
2,5x2,5 cm



Cod. D
2,5x2,5 cm

10x20 cm



5x20 cm



5x40 cm



P.E.I. ③



Cod. C
2,5x2,5 cm



Cod. D
2,5x2,5 cm



Cod. U
10x10 cm



Cod. Z
10x10 cm



Cod. X
10x20 cm



Cod. I
10x20 cm

5x5 cm



10x10 cm



20x20 cm



20x40 cm



Quadra
2,5x20 cm



Stick
1,2x20 cm



Cod. M
2,5x20 cm



Cod. N
2,5x20 cm



Cod. W
2,5x10 cm

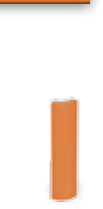

Cod. K
2,5x10 cm



Cod. G
2,5x10 cm



Cod. H
2,5x10 cm



Cod. E
2,5x2,5 cm



Cod. F
2,5x2,5 cm

IG

RF

TR

P.E.I. ③

IN

10x20 cm



5x20 cm



5x40 cm



Cod. C
2,5x2,5 cm

Cod. D
2,5x2,5 cm

Cod. U
10x10 cm

Cod. Z
10x10 cm

Cod. X
10x20 cm

Cod. I
10x20 cm

5x5 cm



10x10 cm



20x20 cm

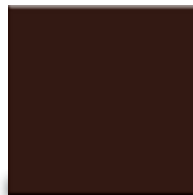

20x40 cm



Stick
1,2x20 cm



Cod. M
2,5x20 cm



Cod. N
2,5x20 cm



Cod. W
2,5x10 cm



Cod. K
2,5x10 cm



Cod. E
2,5x2,5 cm



Cod. F
2,5x2,5 cm

5x5 cm



10x10 cm



20x20 cm



20x40 cm



Quadra
2,5x20 cm



Stick
1,2x20 cm



Cod. M
2,5x20 cm



Cod. N
2,5x20 cm



Cod. W
2,5x10 cm



Cod. K
2,5x10 cm



Cod. G
2,5x10 cm



Cod. H
2,5x10 cm



Cod. E
2,5x2,5 cm



Cod. F
2,5x2,5 cm

IG

RF

TR

IN

10x20 cm



5x20 cm



P.E.I. ①



Cod. C
2,5x2,5 cm



Cod. D
2,5x2,5 cm

10x20 cm



5x20 cm



5x40 cm



P.E.I. ①



Cod. C
2,5x2,5 cm



Cod. D
2,5x2,5 cm



Cod. U
10x10 cm



Cod. Z
10x10 cm



Cod. X
10x20 cm



Cod. I
10x20 cm

5x5 cm



10x10 cm



20x20 cm



20x40 cm



Quadra
2,5x20 cm



Stick
1,2x20 cm



Cod. M
2,5x20 cm



Cod. N
2,5x20 cm



Cod. W
2,5x10 cm



Cod. K
2,5x10 cm



Cod. G
2,5x10 cm



Cod. H
2,5x10 cm



Cod. E
2,5x2,5 cm



Cod. F
2,5x2,5 cm

IG

RF

TR

Bisello
10x20 cm



10x20 cm



5x20 cm



5x40 cm



P.E.I. ①

IN

Cod. C
2,5x2,5 cm



Cod. D
2,5x2,5 cm



Cod. U
10x10 cm



Cod. Z
10x10 cm



Cod. X
10x20 cm



Cod. I
10x20 cm



5x5 cm



10x10 cm



20x20 cm



Bordo Cod. B
10x10 cm



Angolo Cod. I
10x10 cm



Spigolo Cod. E
10x10 cm

5x5 cm



10x10 cm



20x20 cm



20x40 cm



5x5 cm



10x10 cm



20x20 cm

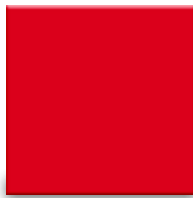

20x40 cm



Stick
1,2x20 cm



Cod. M
2,5x20 cm



Cod. N
2,5x20 cm



Cod. W
2,5x10 cm



Cod. K
2,5x10 cm



Cod. E
2,5x2,5 cm



Cod. F
2,5x2,5 cm

5x5 cm



10x10 cm



20x20 cm



20x40 cm



Quadra
2,5x20 cm



Stick
1,2x20 cm



Cod. M
2,5x20 cm



Cod. N
2,5x20 cm



Cod. W
2,5x10 cm



Cod. K
2,5x10 cm



Cod. G
2,5x10 cm



Cod. H
2,5x10 cm



Cod. E
2,5x2,5 cm



Cod. F
2,5x2,5 cm

P.E.I. ③

IG

P.E.I. ③

RF

P.E.I. ②

TR

P.E.I. ②

IN

10x20 cm

Bisello
10x20 cm

5x20 cm



Cod. C
2,5x2,5 cm



Cod. D
2,5x2,5 cm

10x20 cm



5x20 cm



5x40 cm



Cod. C
2,5x2,5 cm



Cod. D
2,5x2,5 cm



Cod. U
10x10 cm



Cod. Z
10x10 cm



Cod. X
10x20 cm



Cod. I
10x20 cm

5x5 cm



10x10 cm



20x20 cm

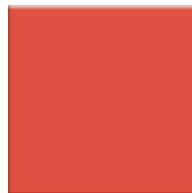

20x40 cm



Stick
1,2x20 cm



Cod. M
2,5x20 cm



Cod. N
2,5x20 cm



Cod. W
2,5x10 cm



Cod. K
2,5x10 cm



Cod. E
2,5x2,5 cm



Cod. F
2,5x2,5 cm

5x5 cm



10x10 cm



20x20 cm

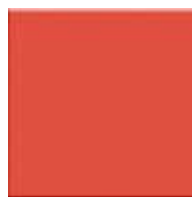

20x40 cm

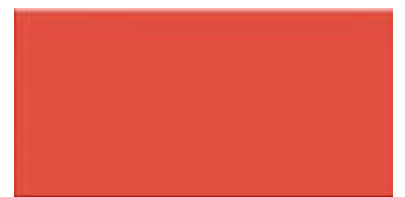

Quadra
2,5x20 cm



Stick
1,2x20 cm



Cod. M
2,5x20 cm



Cod. N
2,5x20 cm



Cod. W
2,5x10 cm



Cod. K
2,5x10 cm



Cod. G
2,5x10 cm



Cod. H
2,5x10 cm



Cod. E
2,5x2,5 cm



Cod. F
2,5x2,5 cm

IG

RF

TR

IN

10x20 cm



5x20 cm



P.E.I. ②



Cod. C
2,5x2,5 cm



Cod. D
2,5x2,5 cm

10x20 cm



5x20 cm



5x40 cm



P.E.I. ②



Cod. C
2,5x2,5 cm



Cod. D
2,5x2,5 cm



Cod. U
10x10 cm



Cod. Z
10x10 cm



Cod. X
10x20 cm



Cod. I
10x20 cm

5x5 cm



10x10 cm



20x20 cm



Bordo Cod. B
10x10 cm



Angolo Cod. I
10x10 cm



Spigolo Cod. E
10x10 cm

5x5 cm



10x10 cm



20x20 cm



20x40 cm



5x5 cm



10x10 cm



20x20 cm

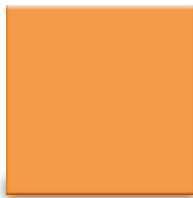

20x40 cm



Stick
1,2x20 cm



Cod. M
2,5x20 cm



Cod. N
2,5x20 cm



Cod. W
2,5x10 cm



Cod. K
2,5x10 cm



Cod. E
2,5x2,5 cm



Cod. F
2,5x2,5 cm

5x5 cm



10x10 cm



20x20 cm



20x40 cm



Quadra
2,5x20 cm



Stick
1,2x20 cm



Cod. M
2,5x20 cm



Cod. N
2,5x20 cm



Cod. W
2,5x10 cm



Cod. K
2,5x10 cm



Cod. G
2,5x10 cm



Cod. H
2,5x10 cm



Cod. E
2,5x2,5 cm



Cod. F
2,5x2,5 cm

P.E.I. ③

IG

Piatto Doccia Grip

P.E.I. ③

RF

P.E.I. ②

TR

10x20 cm

Bisello
10x20 cm

5x20 cm



Cod. C
2,5x2,5 cm



Cod. D
2,5x2,5 cm

P.E.I. ③

IN

10x20 cm

5x20 cm

5x40 cm



Cod. C
2,5x2,5 cm



Cod. D
2,5x2,5 cm



Cod. U
10x10 cm



Cod. Z
10x10 cm



Cod. X
10x20 cm



Cod. I
10x20 cm

5x5 cm



10x10 cm



20x20 cm



20x40 cm



Quadra
2,5x20 cm



Stick
1,2x20 cm



Cod. M
2,5x20 cm



Cod. N
2,5x20 cm



Cod. W
2,5x10 cm



Cod. K
2,5x10 cm



Cod. G
2,5x10 cm



Cod. H
2,5x10 cm



Cod. E
2,5x2,5 cm



Cod. F
2,5x2,5 cm

IG

RF

TR

P.E.I. ④

IN

10x20 cm



5x20 cm



5x40 cm



Cod. C
2,5x2,5 cm

Cod. D
2,5x2,5 cm

Cod. U
10x10 cm

Cod. Z
10x10 cm

Cod. X
10x20 cm

Cod. I
10x20 cm

5x5 cm



10x10 cm



20x20 cm

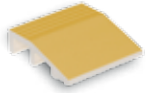

Bordo Cod. B
10x10 cm



Angolo Cod. I
10x10 cm



Spigolo Cod. E
10x10 cm

5x5 cm



10x10 cm



20x20 cm



20x40 cm



5x5 cm



10x10 cm



20x20 cm

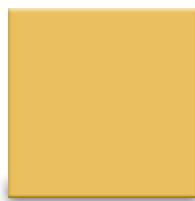

20x40 cm

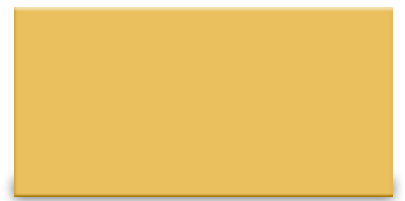

Stick
1,2x20 cm



Cod. M
2,5x20 cm



Cod. N
2,5x20 cm



Cod. W
2,5x10 cm



Cod. K
2,5x10 cm



Cod. E
2,5x2,5 cm



Cod. F
2,5x2,5 cm

5x5 cm



10x10 cm



20x20 cm



20x40 cm



Quadra
2,5x20 cm



Stick
1,2x20 cm



Cod. M
2,5x20 cm



Cod. N
2,5x20 cm



Cod. W
2,5x10 cm



Cod. K
2,5x10 cm



Cod. G
2,5x10 cm



Cod. H
2,5x10 cm



Cod. E
2,5x2,5 cm



Cod. F
2,5x2,5 cm

P.E.I. ③

IG

P.E.I. ③

RF

P.E.I. ②

TR

P.E.I. ③

IN

10x20 cm



5x20 cm



Cod. C
2,5x2,5 cm



Cod. D
2,5x2,5 cm

10x20 cm



5x20 cm



5x40 cm



Cod. C
2,5x2,5 cm



Cod. D
2,5x2,5 cm



Cod. U
10x10 cm



Cod. Z
10x10 cm



Cod. X
10x20 cm



Cod. I
10x20 cm

5x5 cm



10x10 cm



20x20 cm

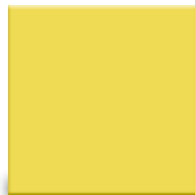

20x40 cm



Stick
1,2x20 cm



Cod. M
2,5x20 cm



Cod. N
2,5x20 cm



Cod. W
2,5x10 cm



Cod. K
2,5x10 cm



Cod. E
2,5x2,5 cm



Cod. F
2,5x2,5 cm

5x5 cm



10x10 cm



20x20 cm



20x40 cm



Quadra
2,5x20 cm



Stick
1,2x20 cm



Cod. M
2,5x20 cm



Cod. N
2,5x20 cm



Cod. W
2,5x10 cm



Cod. K
2,5x10 cm



Cod. G
2,5x10 cm



Cod. H
2,5x10 cm



Cod. E
2,5x2,5 cm



Cod. F
2,5x2,5 cm

IG

RF

TR

IN

10x20 cm



5x20 cm



P.E.I. ②



Cod. C
2,5x2,5 cm



Cod. D
2,5x2,5 cm

10x20 cm



5x20 cm



5x40 cm



P.E.I. ③



Cod. C
2,5x2,5 cm



Cod. D
2,5x2,5 cm



Cod. U
10x10 cm



Cod. Z
10x10 cm



Cod. X
10x20 cm



Cod. I
10x20 cm

5x5 cm



10x10 cm



20x20 cm

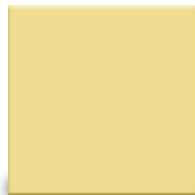

20x40 cm

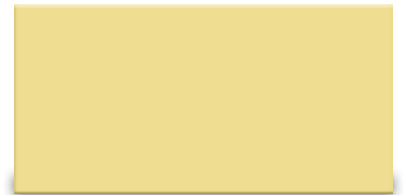

Stick
1,2x20 cm



Cod. M
2,5x20 cm



Cod. N
2,5x20 cm



Cod. W
2,5x10 cm



Cod. K
2,5x10 cm



Cod. E
2,5x2,5 cm



Cod. F
2,5x2,5 cm

5x5 cm



10x10 cm



20x20 cm



20x40 cm



Quadra
2,5x20 cm



Stick
1,2x20 cm



Cod. M
2,5x20 cm



Cod. N
2,5x20 cm



Cod. W
2,5x10 cm



Cod. K
2,5x10 cm



Cod. G
2,5x10 cm



Cod. H
2,5x10 cm



Cod. E
2,5x2,5 cm



Cod. F
2,5x2,5 cm

IG

RF

TR

IN

10x20 cm

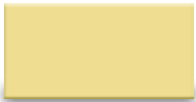

5x20 cm

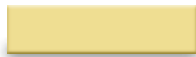

P.E.I. ③



Cod. C
2,5x2,5 cm



Cod. D
2,5x2,5 cm

10x20 cm

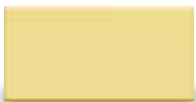

5x20 cm

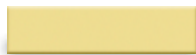

5x40 cm



P.E.I. ④



Cod. C
2,5x2,5 cm



Cod. D
2,5x2,5 cm



Cod. U
10x10 cm



Cod. Z
10x10 cm



Cod. X
10x20 cm



Cod. I
10x20 cm

5x5 cm



10x10 cm



20x20 cm

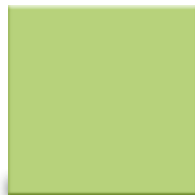

20x40 cm

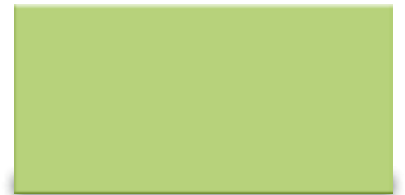

Stick
1,2x20 cm



Cod. M
2,5x20 cm



Cod. N
2,5x20 cm



Cod. W
2,5x10 cm



Cod. K
2,5x10 cm



Cod. E
2,5x2,5 cm



Cod. F
2,5x2,5 cm

5x5 cm



10x10 cm



20x20 cm



20x40 cm



Quadra
2,5x20 cm



Stick
1,2x20 cm



Cod. M
2,5x20 cm



Cod. N
2,5x20 cm



Cod. W
2,5x10 cm



Cod. K
2,5x10 cm



Cod. G
2,5x10 cm



Cod. H
2,5x10 cm



Cod. E
2,5x2,5 cm



Cod. F
2,5x2,5 cm

IG

RF

TR

IN

10x20 cm

Bisello
10x20 cm

5x20 cm

P.E.I. ③

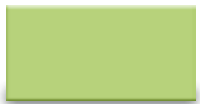

Cod. C
2,5x2,5 cm

Cod. D
2,5x2,5 cm

10x20 cm

5x20 cm

5x40 cm

P.E.I. ④



Cod. C
2,5x2,5 cm

Cod. D
2,5x2,5 cm

Cod. U
10x10 cm

Cod. Z
10x10 cm

Cod. X
10x20 cm

Cod. I
10x20 cm

5x5 cm



10x10 cm



20x20 cm



20x40 cm



Quadra
2,5x20 cm



Stick
1,2x20 cm



Cod. M
2,5x20 cm



Cod. N
2,5x20 cm

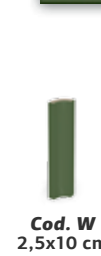

Cod. W
2,5x10 cm



Cod. K
2,5x10 cm



Cod. G
2,5x10 cm



Cod. H
2,5x10 cm



Cod. E
2,5x2,5 cm



Cod. F
2,5x2,5 cm

IG

RF

TR

P.E.I. ②

IN

10x20 cm



5x20 cm



5x40 cm



Cod. C
2,5x2,5 cm

Cod. D
2,5x2,5 cm

Cod. U
10x10 cm

Cod. Z
10x10 cm

Cod. X
10x20 cm

Cod. I
10x20 cm

5x5 cm



10x10 cm



20x20 cm



20x40 cm



Stick
1,2x20 cm



Cod. M
2,5x20 cm



Cod. N
2,5x20 cm



Cod. W
2,5x10 cm



Cod. K
2,5x10 cm



Cod. E
2,5x2,5 cm



Cod. F
2,5x2,5 cm

5x5 cm



10x10 cm



20x20 cm



20x40 cm



Quadra
2,5x20 cm



Stick
1,2x20 cm



Cod. M
2,5x20 cm



Cod. N
2,5x20 cm



Cod. W
2,5x10 cm



Cod. K
2,5x10 cm



Cod. G
2,5x10 cm



Cod. H
2,5x10 cm



Cod. E
2,5x2,5 cm



Cod. F
2,5x2,5 cm

IG

RF

TR

IN

10x20 cm

Bisello
10x20 cm

5x20 cm

P.E.I. ①



Cod. C
2,5x2,5 cm

Cod. D
2,5x2,5 cm

10x20 cm

5x20 cm

5x40 cm

P.E.I. ①



Cod. C
2,5x2,5 cm

Cod. D
2,5x2,5 cm

Cod. U
10x10 cm

Cod. Z
10x10 cm

Cod. X
10x20 cm

Cod. I
10x20 cm

5x5 cm



10x10 cm



20x20 cm



20x40 cm



Stick
1,2x20 cm



Cod. M
2,5x20 cm



Cod. N
2,5x20 cm



Cod. W
2,5x10 cm



Cod. K
2,5x10 cm



Cod. E
2,5x2,5 cm



Cod. F
2,5x2,5 cm

5x5 cm



10x10 cm



20x20 cm



20x40 cm

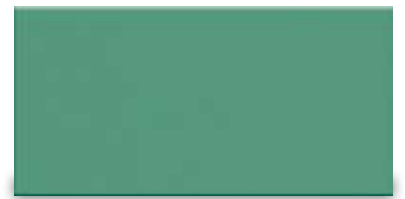

Quadra
2,5x20 cm



Stick
1,2x20 cm



Cod. M
2,5x20 cm



Cod. N
2,5x20 cm



Cod. W
2,5x10 cm



Cod. K
2,5x10 cm



Cod. G
2,5x10 cm



Cod. H
2,5x10 cm



Cod. E
2,5x2,5 cm



Cod. F
2,5x2,5 cm

IG

RF

TR

IN

P.E.I. ①

P.E.I. ②

10x20 cm



5x20 cm



Cod. C
2,5x2,5 cm



Cod. D
2,5x2,5 cm

10x20 cm



5x20 cm



5x40 cm



Cod. C
2,5x2,5 cm



Cod. D
2,5x2,5 cm



Cod. U
10x10 cm



Cod. Z
10x10 cm



Cod. X
10x20 cm



Cod. I
10x20 cm

5x5 cm



10x10 cm



20x20 cm

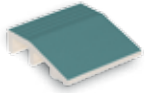

Bordo Cod. B
10x10 cm

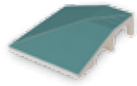

Angolo Cod. I
10x10 cm



Spigolo Cod. E
10x10 cm

5x5 cm



10x10 cm



20x20 cm



20x40 cm



5x5 cm



10x10 cm



20x20 cm



20x40 cm



Stick
1,2x20 cm



Cod. M
2,5x20 cm



Cod. N
2,5x20 cm



Cod. W
2,5x10 cm



Cod. K
2,5x10 cm



Cod. E
2,5x2,5 cm



Cod. F
2,5x2,5 cm

5x5 cm



10x10 cm



20x20 cm



20x40 cm

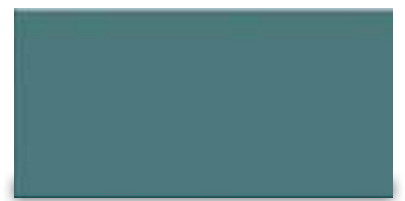

Quadra
2,5x20 cm



Stick
1,2x20 cm



Cod. M
2,5x20 cm



Cod. N
2,5x20 cm



Cod. W
2,5x10 cm



Cod. K
2,5x10 cm



Cod. G
2,5x10 cm



Cod. H
2,5x10 cm



Cod. E
2,5x2,5 cm



Cod. F
2,5x2,5 cm

P.E.I. ②

IG

P.E.I. ②

RF

P.E.I. ②

TR

P.E.I. ②

IN

10x20 cm

Bisello
10x20 cm

5x20 cm



Cod. C
2,5x2,5 cm

Cod. D
2,5x2,5 cm

10x20 cm

5x20 cm

5x40 cm



Cod. C
2,5x2,5 cm

Cod. D
2,5x2,5 cm

Cod. U
10x10 cm

Cod. Z
10x10 cm

Cod. X
10x20 cm

Cod. I
10x20 cm

5x5 cm



10x10 cm



20x20 cm

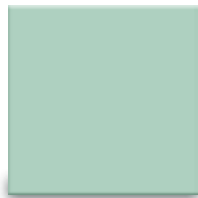

20x40 cm

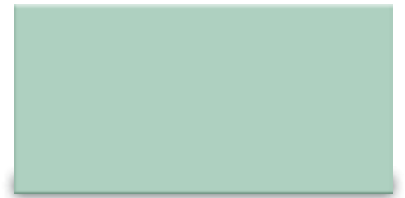

Stick
1,2x20 cm



Cod. M
2,5x20 cm



Cod. N
2,5x20 cm



Cod. W
2,5x10 cm



Cod. K
2,5x10 cm



Cod. E
2,5x2,5 cm



Cod. F
2,5x2,5 cm

5x5 cm



10x10 cm



20x20 cm



20x40 cm



Quadra
2,5x20 cm



Stick
1,2x20 cm



Cod. M
2,5x20 cm



Cod. N
2,5x20 cm



Cod. W
2,5x10 cm



Cod. K
2,5x10 cm



Cod. G
2,5x10 cm



Cod. H
2,5x10 cm



Cod. E
2,5x2,5 cm



Cod. F
2,5x2,5 cm

IG

RF

TR

IN

10x20 cm

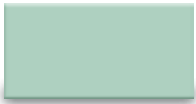

5x20 cm



P.E.I. ③



Cod. C
2,5x2,5 cm



Cod. D
2,5x2,5 cm

10x20 cm



5x20 cm



5x40 cm

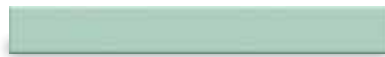

P.E.I. ④



Cod. C
2,5x2,5 cm



Cod. D
2,5x2,5 cm



Cod. U
10x10 cm



Cod. Z
10x10 cm



Cod. X
10x20 cm



Cod. I
10x20 cm

5x5 cm



10x10 cm



20x20 cm

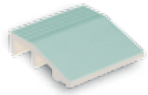

Bordo Cod. B
10x10 cm



Angolo Cod. I
10x10 cm

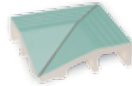

Spigolo Cod. E
10x10 cm

5x5 cm



10x10 cm



20x20 cm



20x40 cm



5x5 cm



10x10 cm



20x20 cm



20x40 cm

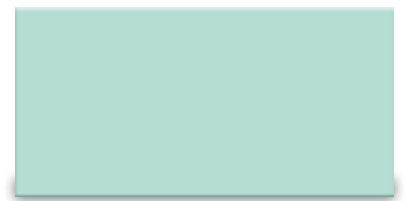

Stick
1,2x20 cm



Cod. M
2,5x20 cm



Cod. N
2,5x20 cm



Cod. W
2,5x10 cm



Cod. K
2,5x10 cm



Cod. E
2,5x2,5 cm



Cod. F
2,5x2,5 cm

5x5 cm



10x10 cm



20x20 cm



20x40 cm



Quadra
2,5x20 cm



Stick
1,2x20 cm



Cod. M
2,5x20 cm



Cod. N
2,5x20 cm



Cod. W
2,5x10 cm



Cod. K
2,5x10 cm



Cod. G
2,5x10 cm



Cod. H
2,5x10 cm



Cod. E
2,5x2,5 cm



Cod. F
2,5x2,5 cm

P.E.I. ④

IG

P.E.I. ④

RF

P.E.I. ③

TR

P.E.I. ④

IN

10x20 cm

Bisello
10x20 cm

5x20 cm



Cod. C
2,5x2,5 cm

Cod. D
2,5x2,5 cm

10x20 cm

5x20 cm

5x40 cm



Cod. C
2,5x2,5 cm

Cod. D
2,5x2,5 cm

Cod. U
10x10 cm

Cod. Z
10x10 cm

Cod. X
10x20 cm

Cod. I
10x20 cm

5x5 cm



10x10 cm



20x20 cm

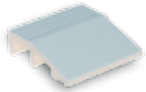

Bordo Cod. B
10x10 cm

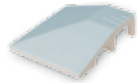

Angolo Cod. I
10x10 cm

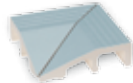

Spigolo Cod. E
10x10 cm

5x5 cm



10x10 cm



20x20 cm



20x40 cm



5x5 cm



10x10 cm



20x20 cm

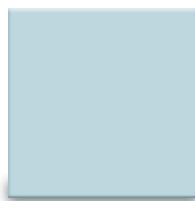

20x40 cm

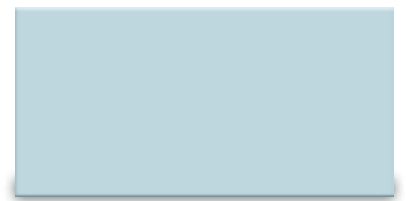

Stick
1,2x20 cm



Cod. M
2,5x20 cm



Cod. N
2,5x20 cm



Cod. W
2,5x10 cm



Cod. K
2,5x10 cm



Cod. E
2,5x2,5 cm



Cod. F
2,5x2,5 cm

5x5 cm



10x10 cm



20x20 cm



20x40 cm

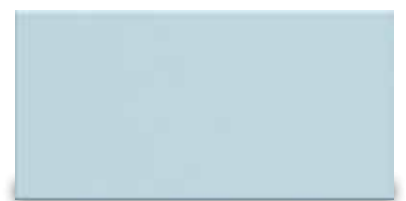

Quadra
2,5x20 cm



Stick
1,2x20 cm



Cod. M
2,5x20 cm



Cod. N
2,5x20 cm



Cod. W
2,5x10 cm



Cod. K
2,5x10 cm



Cod. G
2,5x10 cm



Cod. H
2,5x10 cm



Cod. E
2,5x2,5 cm



Cod. F
2,5x2,5 cm

P.E.I. ④

IG

P.E.I. ④

RF

P.E.I. ③

TR

P.E.I. ④

IN

10x20 cm

Bisello
10x20 cm

5x20 cm



Cod. C
2,5x2,5 cm



Cod. D
2,5x2,5 cm

10x20 cm

5x20 cm

5x40 cm

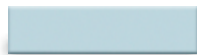
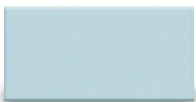

Cod. C
2,5x2,5 cm



Cod. D
2,5x2,5 cm



Cod. U
10x10 cm



Cod. Z
10x10 cm



Cod. X
10x20 cm



Cod. I
10x20 cm

5x5 cm



10x10 cm



20x20 cm

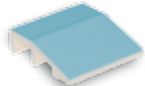

Bordo Cod. B
10x10 cm

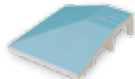

Angolo Cod. I
10x10 cm



Spigolo Cod. E
10x10 cm

5x5 cm



10x10 cm



20x20 cm



20x40 cm



5x5 cm



10x10 cm



20x20 cm

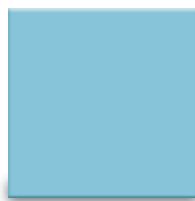

20x40 cm

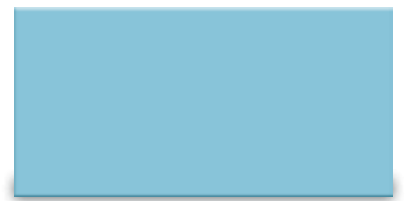

Stick
1,2x20 cm



Cod. M
2,5x20 cm



Cod. N
2,5x20 cm



Cod. W
2,5x10 cm



Cod. K
2,5x10 cm



Cod. E
2,5x2,5 cm



Cod. F
2,5x2,5 cm

5x5 cm



10x10 cm



20x20 cm



20x40 cm



Quadra
2,5x20 cm



Stick
1,2x20 cm



Cod. M
2,5x20 cm



Cod. N
2,5x20 cm



Cod. W
2,5x10 cm



Cod. K
2,5x10 cm



Cod. G
2,5x10 cm



Cod. H
2,5x10 cm



Cod. E
2,5x2,5 cm



Cod. F
2,5x2,5 cm

P.E.I. ③

IG

P.E.I. ③

RF

P.E.I. ②

TR

P.E.I. ③

IN

10x20 cm



5x20 cm



Cod. C
2,5x2,5 cm



Cod. D
2,5x2,5 cm

10x20 cm



5x20 cm



5x40 cm



Cod. C
2,5x2,5 cm



Cod. D
2,5x2,5 cm



Cod. U
10x10 cm



Cod. Z
10x10 cm



Cod. X
10x20 cm



Cod. I
10x20 cm

5x5 cm



10x10 cm



20x20 cm

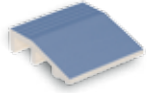

Bordo Cod. B
10x10 cm

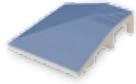

Angolo Cod. I
10x10 cm



Spigolo Cod. E
10x10 cm

5x5 cm



10x10 cm



20x20 cm



20x40 cm



5x5 cm



10x10 cm



20x20 cm

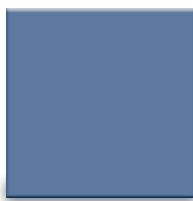

20x40 cm

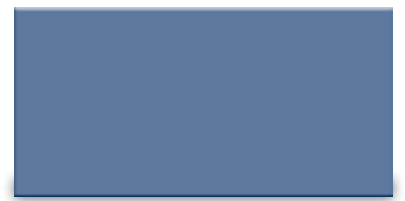

Stick
1,2x20 cm



Cod. M
2,5x20 cm



Cod. N
2,5x20 cm



Cod. W
2,5x10 cm



Cod. K
2,5x10 cm



Cod. E
2,5x2,5 cm



Cod. F
2,5x2,5 cm

5x5 cm



10x10 cm



20x20 cm



20x40 cm



Quadra
2,5x20 cm



Stick
1,2x20 cm



Cod. M
2,5x20 cm



Cod. N
2,5x20 cm



Cod. W
2,5x10 cm



Cod. K
2,5x10 cm



Cod. G
2,5x10 cm



Cod. H
2,5x10 cm



Cod. E
2,5x2,5 cm



Cod. F
2,5x2,5 cm

P.E.I. ③

IG

P.E.I. ③

RF

P.E.I. ①

TR

10x20 cm



5x20 cm



P.E.I. ②

IN

10x20 cm



5x20 cm



5x40 cm



Cod. C
2,5x2,5 cm

Cod. D
2,5x2,5 cm

Cod. C
2,5x2,5 cm

Cod. D
2,5x2,5 cm

Cod. U
10x10 cm

Cod. Z
10x10 cm

Cod. X
10x20 cm

Cod. I
10x20 cm

5x5 cm



10x10 cm



20x20 cm



20x40 cm



Stick
1,2x20 cm



Cod. M
2,5x20 cm



Cod. N
2,5x20 cm



Cod. W
2,5x10 cm



Cod. K
2,5x10 cm



Cod. E
2,5x2,5 cm



Cod. F
2,5x2,5 cm

5x5 cm



10x10 cm



20x20 cm



20x40 cm



Quadra
2,5x20 cm



Stick
1,2x20 cm



Cod. M
2,5x20 cm



Cod. N
2,5x20 cm



Cod. W
2,5x10 cm



Cod. K
2,5x10 cm



Cod. G
2,5x10 cm



Cod. H
2,5x10 cm



Cod. E
2,5x2,5 cm



Cod. F
2,5x2,5 cm

IG

RF

TR

IN

P.E.I. ②

P.E.I. ②

10x20 cm



5x20 cm



Cod. C
2,5x2,5 cm



Cod. D
2,5x2,5 cm

10x20 cm



5x20 cm



5x40 cm



Cod. C
2,5x2,5 cm



Cod. D
2,5x2,5 cm



Cod. U
10x10 cm



Cod. Z
10x10 cm



Cod. X
10x20 cm



Cod. I
10x20 cm

5x5 cm



10x10 cm



20x20 cm

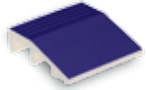

Bordo Cod. B
10x10 cm



Angolo Cod. I
10x10 cm



Spigolo Cod. E
10x10 cm

5x5 cm



10x10 cm



20x20 cm



20x40 cm



5x5 cm



10x10 cm



Bisello
10x10 cm



20x20 cm



20x40 cm



Stick
1,2x20 cm



Cod. M
2,5x20 cm



Cod. N
2,5x20 cm



Cod. W
2,5x10 cm



Cod. K
2,5x10 cm



Cod. E
2,5x2,5 cm



Cod. F
2,5x2,5 cm

5x5 cm



10x10 cm



20x20 cm



20x40 cm



Quadra
2,5x20 cm



Stick
1,2x20 cm



Cod. M
2,5x20 cm



Cod. N
2,5x20 cm



Cod. W
2,5x10 cm



Cod. K
2,5x10 cm



Cod. G
2,5x10 cm



Cod. H
2,5x10 cm



Cod. E
2,5x2,5 cm



Cod. F
2,5x2,5 cm

P.E.I. ①

IG

P.E.I. ①

RF

P.E.I. ①

TR

10x20 cm

Bisello
10x20 cm

5x20 cm



Cod. C
2,5x2,5 cm

Cod. D
2,5x2,5 cm

10x20 cm

5x20 cm

5x40 cm

P.E.I. ①

IN



Cod. C
2,5x2,5 cm

Cod. D
2,5x2,5 cm

Cod. U
10x10 cm

Cod. Z
10x10 cm

Cod. X
10x20 cm

Cod. I
10x20 cm

5x5 cm



10x10 cm



20x20 cm



20x40 cm



Stick
1,2x20 cm



Cod. M
2,5x20 cm



Cod. N
2,5x20 cm



Cod. W
2,5x10 cm



Cod. K
2,5x10 cm



Cod. E
2,5x2,5 cm



Cod. F
2,5x2,5 cm

5x5 cm



10x10 cm



20x20 cm



20x40 cm



Quadra
2,5x20 cm



Stick
1,2x20 cm



Cod. M
2,5x20 cm



Cod. N
2,5x20 cm



Cod. W
2,5x10 cm



Cod. K
2,5x10 cm



Cod. G
2,5x10 cm



Cod. H
2,5x10 cm



Cod. E
2,5x2,5 cm



Cod. F
2,5x2,5 cm

IG

RF

TR

IN

10x20 cm



5x20 cm



P.E.I. ①



Cod. C
2,5x2,5 cm



Cod. D
2,5x2,5 cm

10x20 cm



5x20 cm



5x40 cm



P.E.I. ②



Cod. C
2,5x2,5 cm



Cod. D
2,5x2,5 cm



Cod. U
10x10 cm



Cod. Z
10x10 cm



Cod. X
10x20 cm



Cod. I
10x20 cm

5x5 cm



10x10 cm



20x20 cm



20x40 cm

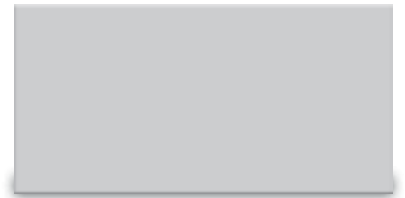

Stick
1,2x20 cm



Cod. M
2,5x20 cm



Cod. N
2,5x20 cm



Cod. W
2,5x10 cm



Cod. K
2,5x10 cm



Cod. E
2,5x2,5 cm



Cod. F
2,5x2,5 cm

5x5 cm



10x10 cm



20x20 cm



20x40 cm

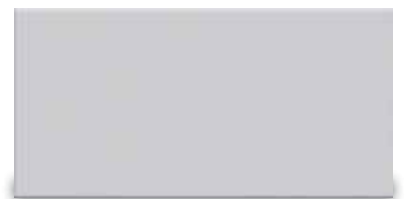

Quadra
2,5x20 cm



Stick
1,2x20 cm



Cod. M
2,5x20 cm



Cod. N
2,5x20 cm



Cod. W
2,5x10 cm



Cod. K
2,5x10 cm



Cod. G
2,5x10 cm



Cod. H
2,5x10 cm



Cod. E
2,5x2,5 cm



Cod. F
2,5x2,5 cm

IG

RF

TR

IN

10x20 cm

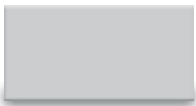

5x20 cm



P.E.I. ③



Cod. C
2,5x2,5 cm



Cod. D
2,5x2,5 cm

10x20 cm



5x20 cm



5x40 cm



P.E.I. ④



Cod. C
2,5x2,5 cm



Cod. D
2,5x2,5 cm



Cod. U
10x10 cm



Cod. Z
10x10 cm



Cod. X
10x20 cm



Cod. I
10x20 cm

5x5 cm



10x10 cm



20x20 cm

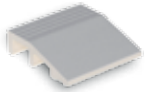

Bordo Cod. B
10x10 cm

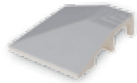

Angolo Cod. I
10x10 cm



Spigolo Cod. E
10x10 cm

5x5 cm



10x10 cm



20x20 cm



20x40 cm



5x5 cm



10x10 cm



20x20 cm



20x40 cm

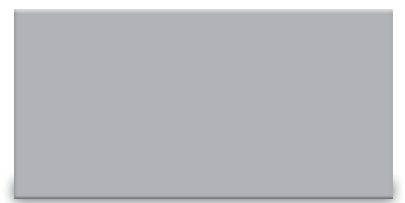

Stick
1,2x20 cm



Cod. M
2,5x20 cm



Cod. N
2,5x20 cm



Cod. W
2,5x10 cm



Cod. K
2,5x10 cm



Cod. E
2,5x2,5 cm



Cod. F
2,5x2,5 cm

5x5 cm



10x10 cm



20x20 cm



20x40 cm

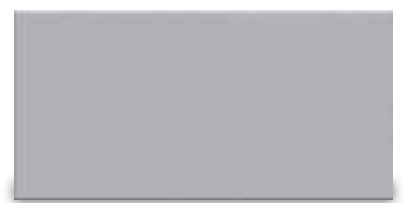

Quadra
2,5x20 cm



Stick
1,2x20 cm



Cod. M
2,5x20 cm



Cod. N
2,5x20 cm



Cod. W
2,5x10 cm



Cod. K
2,5x10 cm



Cod. G
2,5x10 cm



Cod. H
2,5x10 cm



Cod. E
2,5x2,5 cm



Cod. F
2,5x2,5 cm

P.E.I. ④

IG

P.E.I. ④

RF

P.E.I. ③

TR

P.E.I. ④

IN

10x20 cm



5x20 cm



Cod. C
2,5x2,5 cm



Cod. D
2,5x2,5 cm

10x20 cm



5x20 cm



5x40 cm



Cod. C
2,5x2,5 cm



Cod. D
2,5x2,5 cm



Cod. U
10x10 cm



Cod. Z
10x10 cm



Cod. X
10x20 cm



Cod. I
10x20 cm

5x5 cm



10x10 cm



20x20 cm



20x40 cm

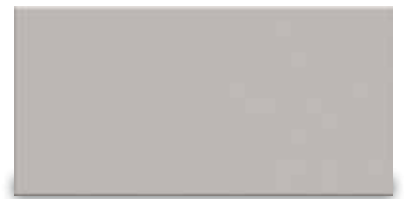

Quadra
2,5x20 cm



Stick
1,2x20 cm



Cod. M
2,5x20 cm



Cod. N
2,5x20 cm



Cod. W
2,5x10 cm



Cod. K
2,5x10 cm



Cod. G
2,5x10 cm



Cod. H
2,5x10 cm



Cod. E
2,5x2,5 cm



Cod. F
2,5x2,5 cm

IG

RF

TR

Bisello
10x20 cm



10x20 cm



5x20 cm



5x40 cm



P.E.I. ③

IN

Cod. C
2,5x2,5 cm



Cod. D
2,5x2,5 cm



Cod. U
10x10 cm



Cod. Z
10x10 cm



Cod. X
10x20 cm



Cod. I
10x20 cm



5x5 cm



10x10 cm



20x20 cm

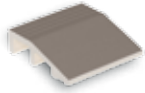

Bordo Cod. B
10x10 cm

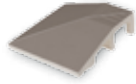

Angolo Cod. I
10x10 cm



Spigolo Cod. E
10x10 cm

5x5 cm



10x10 cm



20x20 cm



20x40 cm



5x5 cm



10x10 cm



20x20 cm



20x40 cm



Stick
1,2x20 cm



Cod. M
2,5x20 cm



Cod. N
2,5x20 cm



Cod. W
2,5x10 cm



Cod. K
2,5x10 cm



Cod. E
2,5x2,5 cm



Cod. F
2,5x2,5 cm

5x5 cm



10x10 cm

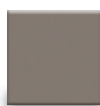

20x20 cm

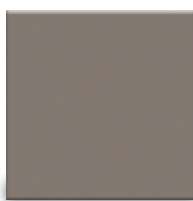

20x40 cm

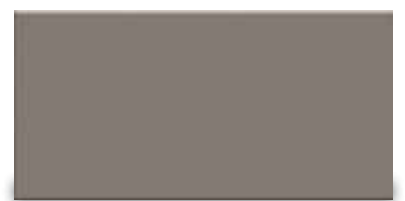

Quadra
2,5x20 cm



Stick
1,2x20 cm



Cod. M
2,5x20 cm



Cod. N
2,5x20 cm



Cod. W
2,5x10 cm



Cod. K
2,5x10 cm



Cod. G
2,5x10 cm



Cod. H
2,5x10 cm



Cod. E
2,5x2,5 cm



Cod. F
2,5x2,5 cm

P.E.I. ③

IG

P.E.I. ③

RF

P.E.I. ①

TR

P.E.I. ②

IN

10x20 cm

Bisello
10x20 cm

5x20 cm



Cod. C
2,5x2,5 cm

Cod. D
2,5x2,5 cm



10x20 cm

5x20 cm

5x40 cm

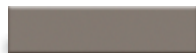
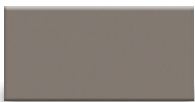

Cod. C
2,5x2,5 cm

Cod. D
2,5x2,5 cm



Cod. U
10x10 cm



Cod. Z
10x10 cm



Cod. X
10x20 cm



Cod. I
10x20 cm

5x5 cm



10x10 cm



20x20 cm



20x40 cm



Stick
1,2x20 cm



Cod. M
2,5x20 cm



Cod. N
2,5x20 cm



Cod. W
2,5x10 cm



Cod. K
2,5x10 cm



Cod. E
2,5x2,5 cm



Cod. F
2,5x2,5 cm

5x5 cm



10x10 cm



20x20 cm



20x40 cm



Quadra
2,5x20 cm



Stick
1,2x20 cm



Cod. M
2,5x20 cm



Cod. N
2,5x20 cm



Cod. W
2,5x10 cm



Cod. K
2,5x10 cm



Cod. G
2,5x10 cm



Cod. H
2,5x10 cm



Cod. E
2,5x2,5 cm



Cod. F
2,5x2,5 cm

IG

RF

TR

IN

10x20 cm



5x20 cm



P.E.I. ①



Cod. C
2,5x2,5 cm



Cod. D
2,5x2,5 cm

10x20 cm



5x20 cm



5x40 cm



P.E.I. ②



Cod. C
2,5x2,5 cm



Cod. D
2,5x2,5 cm



Cod. U
10x10 cm



Cod. Z
10x10 cm



Cod. X
10x20 cm



Cod. I
10x20 cm

5x5 cm



10x10 cm



20x20 cm

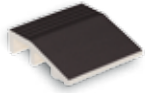

Bordo Cod. B
10x10 cm

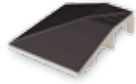

Angolo Cod. I
10x10 cm



Spigolo Cod. E
10x10 cm

5x5 cm



10x10 cm



20x20 cm



20x40 cm



5x5 cm



10x10 cm



Bisello

10x10 cm



20x20 cm

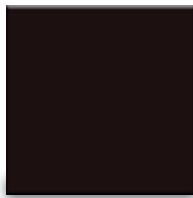

20x40 cm



Stick
1,2x20 cm



Cod. M
2,5x20 cm



Cod. N
2,5x20 cm



Cod. W
2,5x10 cm



Cod. K
2,5x10 cm



Cod. E
2,5x2,5 cm



Cod. F
2,5x2,5 cm

5x5 cm



10x10 cm



20x20 cm



20x40 cm



Quadra
2,5x20 cm



Stick
1,2x20 cm



Cod. M
2,5x20 cm



Cod. N
2,5x20 cm



Cod. W
2,5x10 cm



Cod. K
2,5x10 cm



Cod. G
2,5x10 cm



Cod. H
2,5x10 cm



Cod. E
2,5x2,5 cm



Cod. F
2,5x2,5 cm

P.E.I. ①

IG

P.E.I. ①

RF

P.E.I. ①

TR

10x20 cm

Bisello
10x20 cm

5x20 cm



Cod. C
2,5x2,5 cm



Cod. D
2,5x2,5 cm

10x20 cm



5x20 cm



5x40 cm



Cod. C
2,5x2,5 cm



Cod. D
2,5x2,5 cm



Cod. U
10x10 cm



Cod. Z
10x10 cm



Cod. X
10x20 cm



Cod. I
10x20 cm

P.E.I. ①

IN

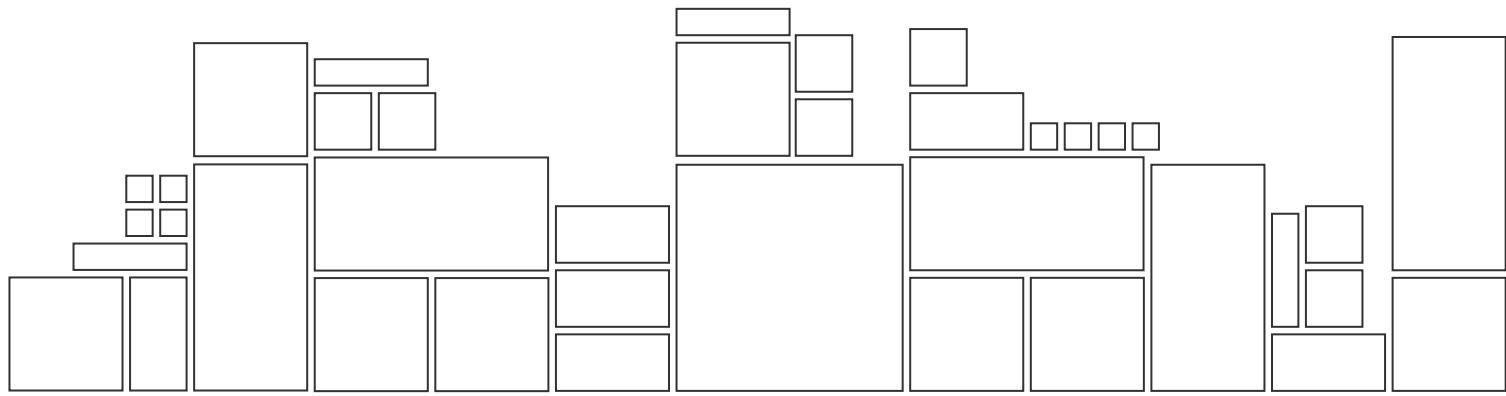

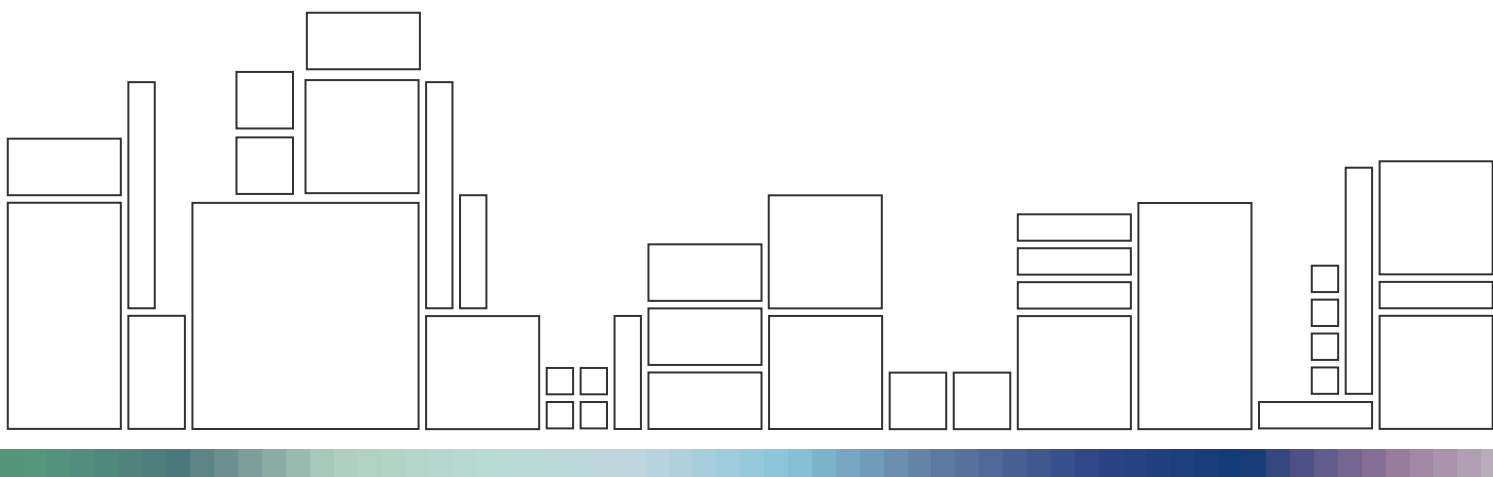

VOGUE Link

Interni Mix

Trasparenze Mix

Flooring Mix R10 B (A+B)

Grip Mix R11 C (A+B+C)

Cos'è Vogue Link

La collezione Vogue Link raggruppa prodotti che sono derivati dal Vogue System e con esso si integrano per formati e finiture. Pensata per soluzioni decorative sia in ambito residenziale che pubblico, ideale per pavimenti e rivestimenti in base alle caratteristiche della superficie utilizzata. Le molteplici proposte cromatiche offrono soluzioni progettuali in grado di rendere unico ogni ambiente.

What is Vogue Link

The Vogue Link collection brings products originating from the Vogue System range together, resulting in a perfect match of sizes and finishes. Intended as decorative solutions for private and public applications, they are ideal for floor and wall coverings offering the benefits of the features of the surface used. The vast range of colours makes it possible to design solutions that will make any space truly unique.

Was ist Vogue Link

Die Kollektion Vogue Link vereint Produkte, die vom Vogue System abgeleitet sind und dieses bezüglich der Formate und Oberflächenausführungen ergänzen. Sie ist für Dekorationslösungen sowohl im Wohnbereich als auch in der Öffentlichkeit gedacht und ideal für Fußböden und Verkleidungen, je nach den Eigenschaften der verwendeten Oberfläche. Das vielfältige farbliche Angebot bietet planerische Lösungen, die fähig sind, jede Umgebung einzigartig zu gestalten.

Qu'est-ce que Vogue Link

La collection Vogue Link comprend des produits dérivés du Vogue System dont elle intègre les formats et les finitions. Elle a été imaginée pour revêtir les sols et les murs des espaces résidentiels et publics, selon les caractéristiques de la surface utilisée. Les multiples propositions chromatiques proposent des projets permettant de donner à chaque espace un cachet tout à fait unique.

Interni Mix - trasparenze Mix - Flooring Mix R10 B (A+B) - Grip Mix R11 C (A+B+C)

Nell'ambito del programma Vogue Link , nascono le serie di miscele Interni Mix, trasparenze Mix, Flooring Mix e Grip Mix; nuove soluzioni decorative da abbinare all'ampia gamma di colori e formati di Vogue System. Le miscele in gres porcellanato smaltato ingelivo, nel formato cm 5x5, grazie alle 52 sfumature di colore proposte nella finitura satinata, lucida e antiscivolo, sono pensate per fornire ampie possibilità progettuali e fantasiose alternative alla tinta unita.

Adatte per pavimenti e rivestimenti, interni ed esterni, nel formato cm 5x5 assemblato su rete in fibra di vetro, f.to finito cm 30x30.

The Interni Mix, trasparenze Mix, Flooring Mix and Grip Mix series form part of the Vogue Link programme. These new decorative solutions can be combined with the wide range of colours and formats that make up the Vogue System.

The frost-resistant glazed porcelain stoneware mixes, in the 5x5 cm format, come in 52 non-slip, satin- and gloss-finish shades and are designed to offer a whole host of imaginative design alternatives to single plain colours.

Suitable for both floors and walls, indoors and outdoors, the fibreglass mesh-backed 5x5 cm format creates a finished size of 30x30 cm.

Die Mischungen Interni Mix, trasparenze Mix, Flooring Mix und Grip Mix wurden im Zusammenhang mit dem Vogue Link Programm entwickelt. Diese neuen Dekorationslösungen können mit einem umfassenden Angebot an Farben und Formaten des Vogue Systems kombiniert werden.

Die Mischungen aus temperaturunempfindlichem glasiertem lackiertem Steingut im Format 5x5 cm liefern dank der 52 Tönungen mit mattem, glänzendem oder rutschhemmendem Finish zahlreiche planerische Möglichkeiten und phantasievolle Alternativen zu einfarbigen Lösungen.

Geeignet für interne und externe Böden und Verkleidungen im Format 5x5 cm auf Glasfasergitter im Format 30x30 cm.

Dans le cadre du programme Vogue Link, nous vous proposons les séries Interni Mix, trasparenze Mix, Flooring Mix et Grip Mix : de nouvelles solutions décoratives à associer à la vaste gamme de coloris et de formats Vogue System.

Grâce aux 52 nuances de couleur proposées dans les finitions satinée, brillante et antidérapante, les panneaux en grès cérame émaillé ingélif, composés de carreaux de format 5x5 cm, permettent d'envisager toutes sortes de rendus et offrent une alternative originale aux teintes unies.

S'utilise en tant que carrelage de sol, revêtement mural, intérieur et extérieur, format 5x5 assemblé sur un maillage en fibre de verre, format du panneau: 30 x 30 cm

Interni Mix *superficie satinata satin-finish surface satinierte Oberfläche surface satinée*



M IN 01

M IN 02

M IN 03

M IN 04

M IN 05

M IN 06

M IN 07

M IN 08

M IN 09

M IN 10

M IN 11

Utilizzo: interni ed esterni, pavimenti e rivestimenti
 Use: internal and external, floor and wall tiling
 Einsatzbereich: Innen- und Außenbereiche, Bodenbeläge und Wandverkleidungen
 Utilisation: intérieurs et extérieurs, revêtements de sols et de murs

Formati
 Sizes
 Formate
 Formats

30x30
 (5x5)
 12"x12"
 (2"x2")

0,7 cm

montato su rete in fibra di vetro
 mesh-backed fiberglass
 einem Glasfasernetz zusammengesetzt wird
 assemblés sur filet en fibre de verre

Trasparenze Mix *superficie lucida glossy surface glänzende Oberfläche surface lustrée*

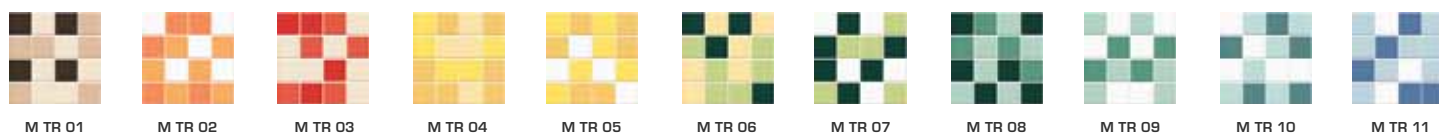

M TR 01

M TR 02

M TR 03

M TR 04

M TR 05

M TR 06

M TR 07

M TR 08

M TR 09

M TR 10

M TR 11

Utilizzo: interni ed esterni, rivestimento
 Use: internal and external, wall tiling
 Einsatzbereich: Innen- und Außenbereiche, Wandverkleidung
 Utilisation: intérieurs et extérieurs, revêtements de murs

Formati
 Sizes
 Formate
 Formats

30x30
 (5x5)
 12"x12"
 (2"x2")

0,7 cm

montato su rete in fibra di vetro
 mesh-backed fiberglass
 einem Glasfasernetz zusammengesetzt wird
 assemblés sur filet en fibre de verre

Flooring Mix R10 B (A+B) / Grip Mix R11 C (A+B+C) *superficie antiscivolo satinata satin-finish non-slip*

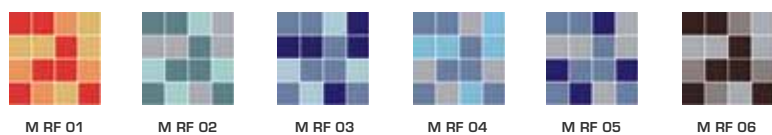

M RF 01

M RF 02

M RF 03

M RF 04

M RF 05

M RF 06

Utilizzo: interni ed esterni, pavimenti - R10 B (A+B)
 Use: internal and external, floors - R10 B (A+B)
 Einsatzbereich: Innen- und Außenbereiche, Bodenbeläge - R10 B (A+B)
 Utilisation: intérieurs et extérieurs, revêtements de sols - R10 B (A+B)

Formati
 Sizes
 Formate
 Formats

30x30
 (5x5)
 12"x12"
 (2"x2")

0,7 cm

montato su rete in fibra di vetro
 mesh-backed fiberglass
 einem Glasfasernetz zusammengesetzt wird
 assemblés sur filet en fibre de verre

M IN - Interni Mix

M TR - Trasparenze Mix

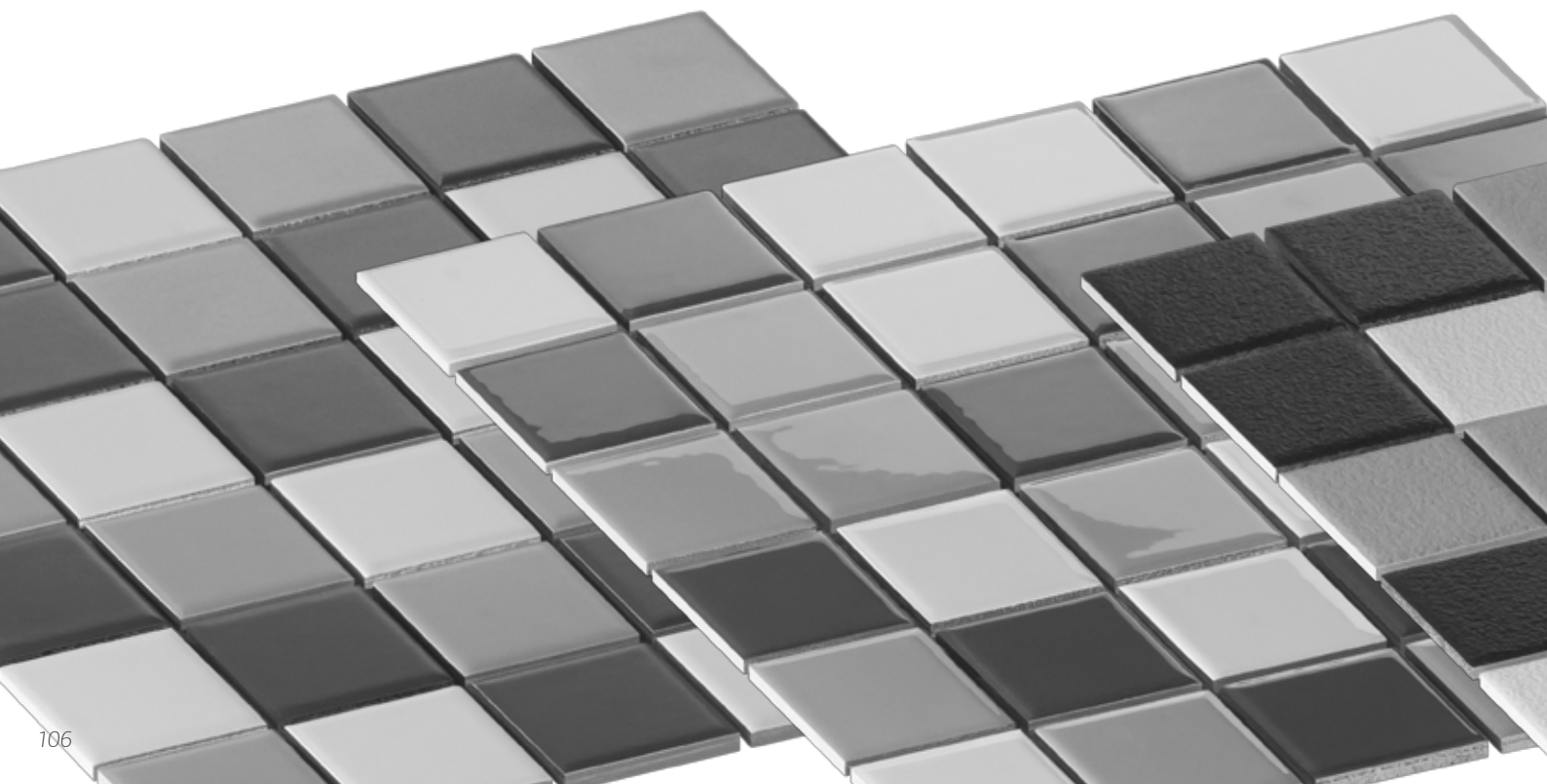



surface satinée, rutschfeste Oberfläche surface anti-dérapante satinée



Utilizzo: interni ed esterni, pavimenti - R11 C (A+B+C)
 Use: internal and external, floors - R11 C (A+B+C)
 Einsatzbereich: Innen- und Außenbereiche, Bodenbeläge - R11 C (A+B+C)
 Utilisation: intérieurs et extérieurs, revêtements de sols - R11 C (A+B+C)

Formati
 Sizes
 Formate
 Formats

30x30
 (5x5)
 12"x12"
 (2'x2')

0,7 cm

montato su rete in fibra di vetro
 mesh-backed fiberglass
 einem Glasfasernetz zusammengesetzt wird
 assemblés sur filet en fibre de verre

M RF - Flooring Mix R10 B (A+B)

M IG - Grip Mix R11 C (A+B+C)

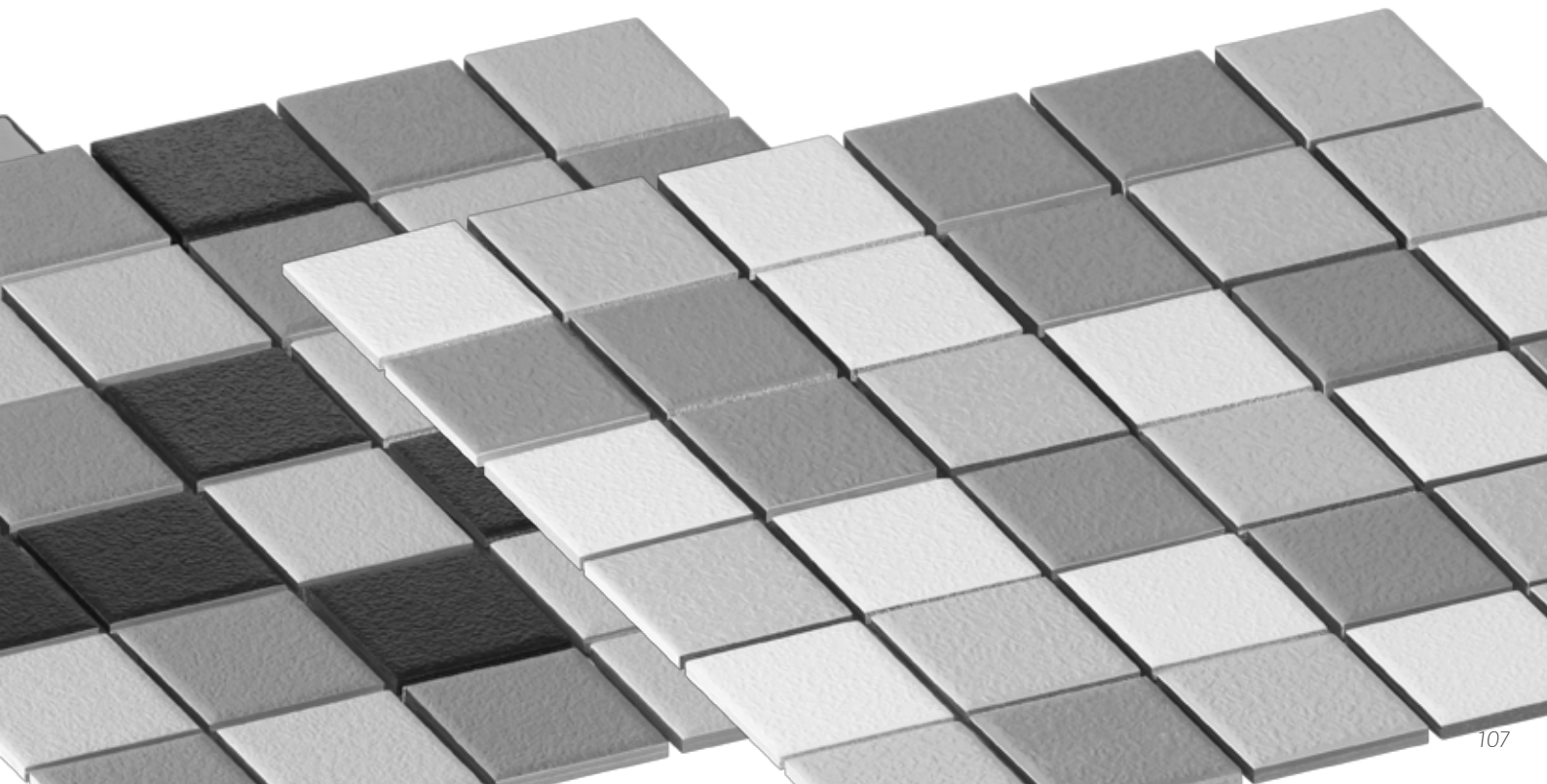

M IN 01

IN latte 33%
 IN seta 33%
 IN nocciola 33%

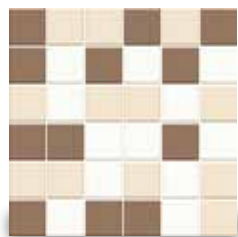

30x30 cm

M IN 02

IN seta 33%
 IN tortora 33%
 IN nocciola 33%



30x30 cm

M IN 03

IN nocciola 33%
 IN tortora 33%
 IN caffè 33%



30x30 cm

M IN 04

IN seta 33%
 IN tortora 33%
 IN bordeaux 33%

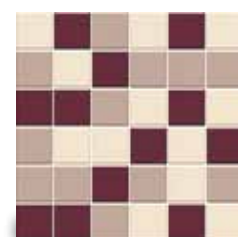

30x30 cm

M IN 05

IN latte 33%
 IN rosa 33%
 IN bordeaux 33%

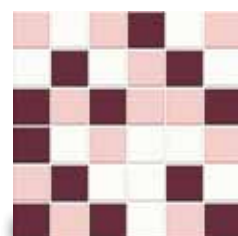

30x30 cm

M IN 06

IN latte 33%
 IN papaya 33%
 IN mandarino 33%

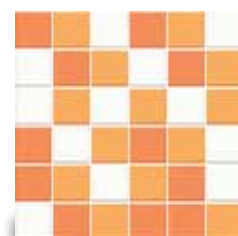

30x30 cm

M IN 07

IN seta 33%
 IN rosso 33%
 IN corallo 33%

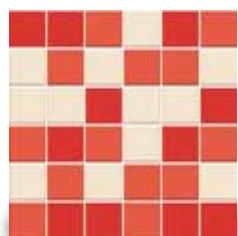

30x30 cm

M IN 08

IN girasole 33%
 IN cedro 33%
 IN pompelmo 33%

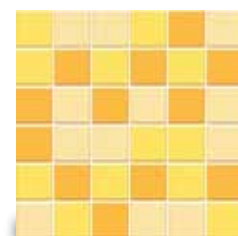

30x30 cm

M IN 09

IN ghiaccio 33%
 IN girasole 33%
 IN giallo 33%

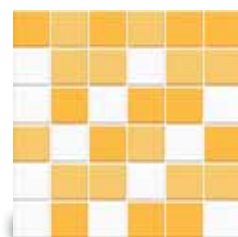

30x30 cm

M IN 10

IN pompelmo 33%
 IN pistacchio 33%
 IN oliva 33%

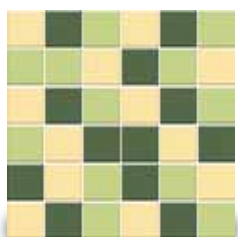

30x30 cm

M IN 11

IN ghiaccio 33%
 IN pistacchio 33%
 IN oliva 33%

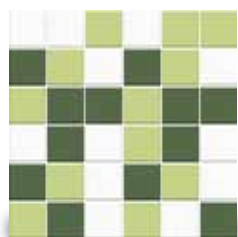

30x30 cm

M IN 12

IN pistacchio 33%
 IN oliva 33%
 IN menta 33%

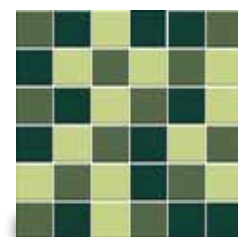

30x30 cm

M IN 13

IN menta 33%
 IN smeraldo 33%
 IN giada 33%

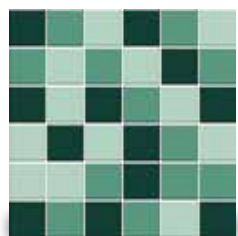

30x30 cm

M IN 14

IN latte 33%
 IN smeraldo 33%
 IN giada 33%

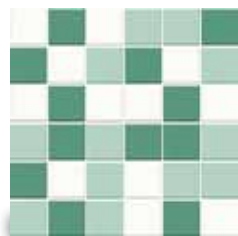

30x30 cm

M IN 15

IN ghiaccio 33%
 IN turchese 33%
 IN laguna 33%

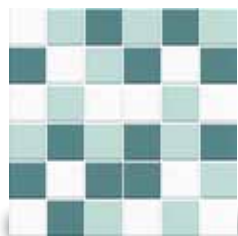

30x30 cm

M IN 16

IN ghiaccio 33%
 IN azzurro 33%
 IN blu avio 33%

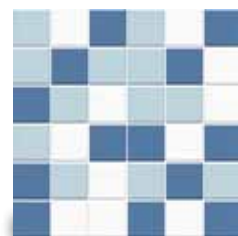

30x30 cm

M IN 17

IN blu avio 33%
 IN oltremare 33%
 IN lilla 33%



30x30 cm

M IN 18

IN lavanda 33%
 IN lilla 33%
 IN perla 33%

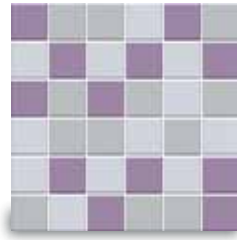

30x30 cm

M IN 19

IN ghiaccio 33%
 IN argento 33%
 IN grigio 33%

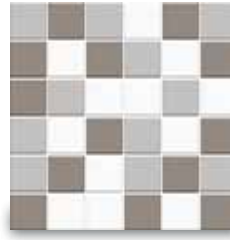

30x30 cm

M IN 20

IN argento 33%
 IN grigio 33%
 IN ferro 33%



30x30 cm

M IN 21

IN grigio 33%
 IN ferro 33%
 IN nero 33%



30x30 cm

S IN 01

IN ghiaccio 50%
 IN nero 50%

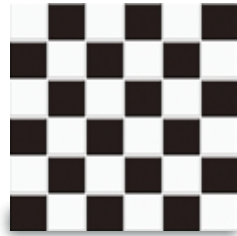

30x30 cm

Utilizzo: interni ed esterni, pavimenti e rivestimenti
 Use: internal and external, floor and wall tiling
 Einsatzbereich: Innen- und Außenbereiche, Bodenbeläge und Wandverkleidungen
 Utilisation: intérieurs et extérieurs, revêtements de sols et de murs

Formati
 Sizes
 Formate
 Formats

30x30
 (5x5)
 12"x12"
 (2'x2')

0,7 cm

montato su rete in fibra di vetro
 mesh-backed fiberglass
 einem Glasfasernetz zusammengesetzt wird
 assemblés sur filet en fibre de verre

M TR 01

TR seta 33%
TR beige 33%
TR caffè 33%



30x30 cm

M TR 02

TR ghiaccio 33%
TR papaya 33%
TR mandarino 33%

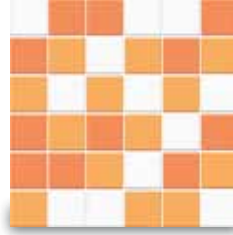

30x30 cm

M TR 03

TR seta 33%
TR rosso 33%
TR corallo 33%

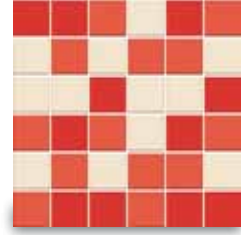

30x30 cm

M TR 04

TR giallo 33%
TR cedro 33%
TR pompelmo 33%

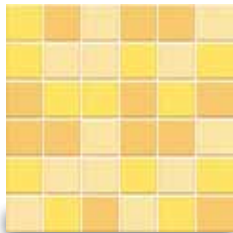

30x30 cm

M TR 05

TR ghiaccio 33%
TR giallo 33%
TR cedro 33%

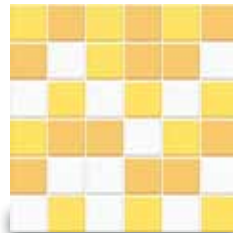

30x30 cm

M TR 06

TR pompelmo 33%
TR pistacchio 33%
TR menta 33%

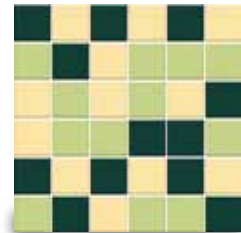

30x30 cm

M TR 07

TR ghiaccio 33%
TR pistacchio 33%
TR menta 33%

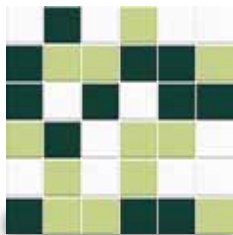

30x30 cm

M TR 08

TR menta 33%
TR smeraldo 33%
TR giada 33%

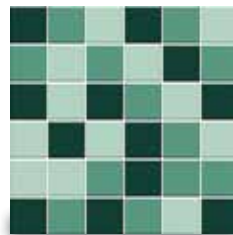

30x30 cm

M TR 09

TR ghiaccio 33%
TR smeraldo 33%
TR giada 33%

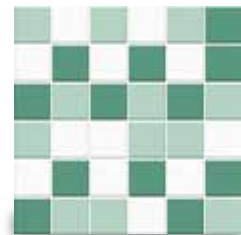

30x30 cm

M TR 10

TR ghiaccio 33%
TR turchese 33%
TR laguna 33%

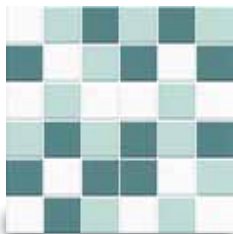

30x30 cm

M TR 11

TR ghiaccio 33%
TR azzurro 33%
TR blu avio 33%

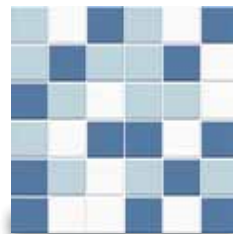

30x30 cm

M TR 12

TR azzurro 33%
TR cielo 33%
TR blu avio 33%

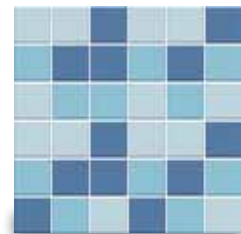

30x30 cm

M TR 13

TR blu avio 33%
TR oltremare 33%
TR lilla 33%



30x30 cm

M TR 14

TR blu avio 33%
TR lilla 33%
TR perla 33%

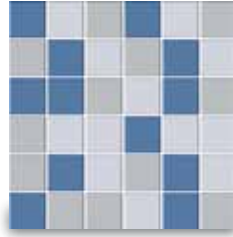

30x30 cm

M TR 15

TR lavanda 33%
TR lilla 33%
TR perla 33%

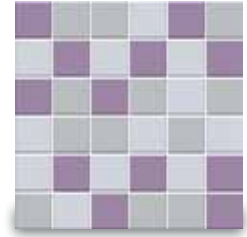

30x30 cm

M TR 16

TR perla 33%
TR grigio 33%
TR ferro 33%



30x30 cm

M TR 17

TR grigio 33%
TR ferro 33%
TR nero 33%

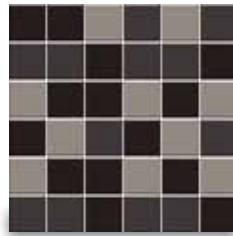

30x30 cm

S TR 01

TR ghiaccio 50%
TR nero 50%

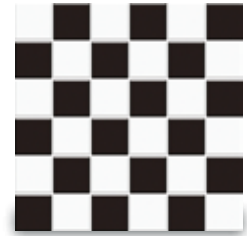

30x30 cm

Utilizzo: interni ed esterni, rivestimento
Use: internal and external, wall tiling
Einsatzbereich: Innen- und Außenbereiche, Wandverkleidung
Utilisation: intérieurs et extérieurs, revêtements de murs

Formati
Sizes
Formate
Formats

30x30
(5x5)
12"x12"
(2'x2')

0,7 cm

montato su rete in fibra di vetro
mesh-backed fiberglass
einem Glasfasernetz zusammengesetzt wird
assemblés sur filet en fibre de verre

M RF 01

RF mandarino 33%
RF giallo 33%
RF rosso 33%

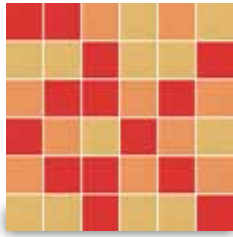

30x30 cm

M RF 02

RF turchese 33%
RF laguna 33%
RF perla 33%

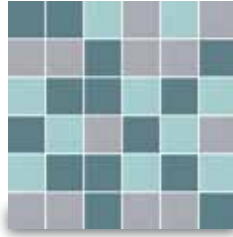

30x30 cm

M RF 03

RF azzurro 33%
RF blu avio 33%
RF cobalto 33%

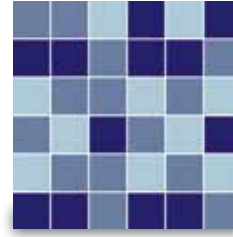

30x30 cm

M RF 04

RF cielo 33%
RF blu avio 33%
RF perla 33%

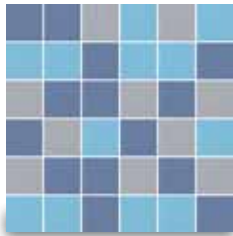

30x30 cm

M RF 05

RF blu avio 33%
RF cobalto 33%
RF perla 33%

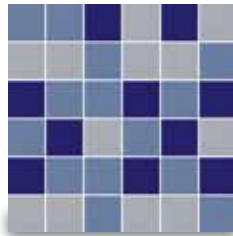

30x30 cm

M RF 06

RF perla 33%
RF grigio 33%
RF nero 33%

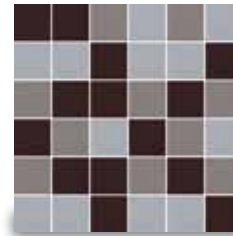

30x30 cm

Utilizzo: interni ed esterni, pavimenti - R10 B (A+B)
Use: internal and external, floors - R10 B (A+B)
Einsatzbereich: Innen- und Außenbereiche, Bodenbeläge - R10 B (A+B)
Utilisation: intérieurs et extérieurs, revêtements de sols - R10 B (A+B)

Formati
Sizes
Formate
Formats

30x30
(5x5)
12"x12"
(2'x2') } $\begin{matrix} \nabla \\ \equiv \\ \blacktriangle \end{matrix}$ 0,7 cm

montato su rete in fibra di vetro
mesh-backed fiberglass
einem Glasfasernetz zusammengesetzt wird
assemblés sur filet en fibre de verre

M IG 01

IG ghiaccio 33%
 IG mandarino 33%
 IG giallo 33%

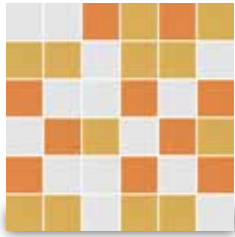

30x30 cm

M IG 02

IG ghiaccio 33%
 IG turchese 33%
 IG laguna 33%

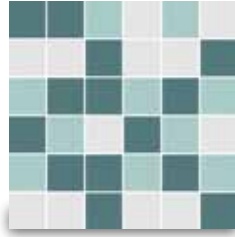

30x30 cm

M IG 03

IG ghiaccio 33%
 IG azzurro 33%
 IG blu avio 33%

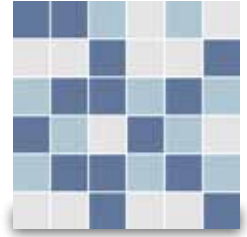

30x30 cm

M IG 04

IG azzurro 33%
 IG cielo 33%
 IG blu avio 33%

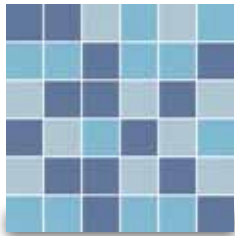

30x30 cm

M IG 05

IG ghiaccio 33%
 IG blu avio 33%
 IG cobalto 33%

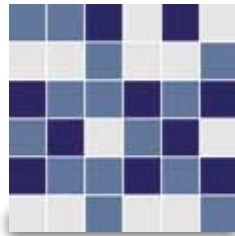

30x30 cm

M IG 06

IG ghiaccio 33%
 IG perla 33%
 IG grigio 33%

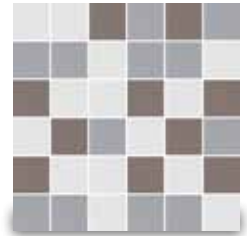

30x30 cm

Utilizzo: interni ed esterni, pavimenti - R11 C (A+B+C)
 Use: internal and external, floors - R11 C (A+B+C)
 Einsatzbereich: Innen- und Außenbereiche, Bodenbeläge - R11 C (A+B+C)
 Utilisation: intérieurs et extérieurs, revêtements de sols - R11 C (A+B+C)

Formati
 Sizes
 Formate
 Formats

30x30
 (5x5)
 12"x12"
 (2'x2')

0,7 cm

montato su rete in fibra di vetro
 mesh-backed fiberglass
 einem Glasfasernetz zusammengesetzt wird
 assembled sur filet en fibre de verre

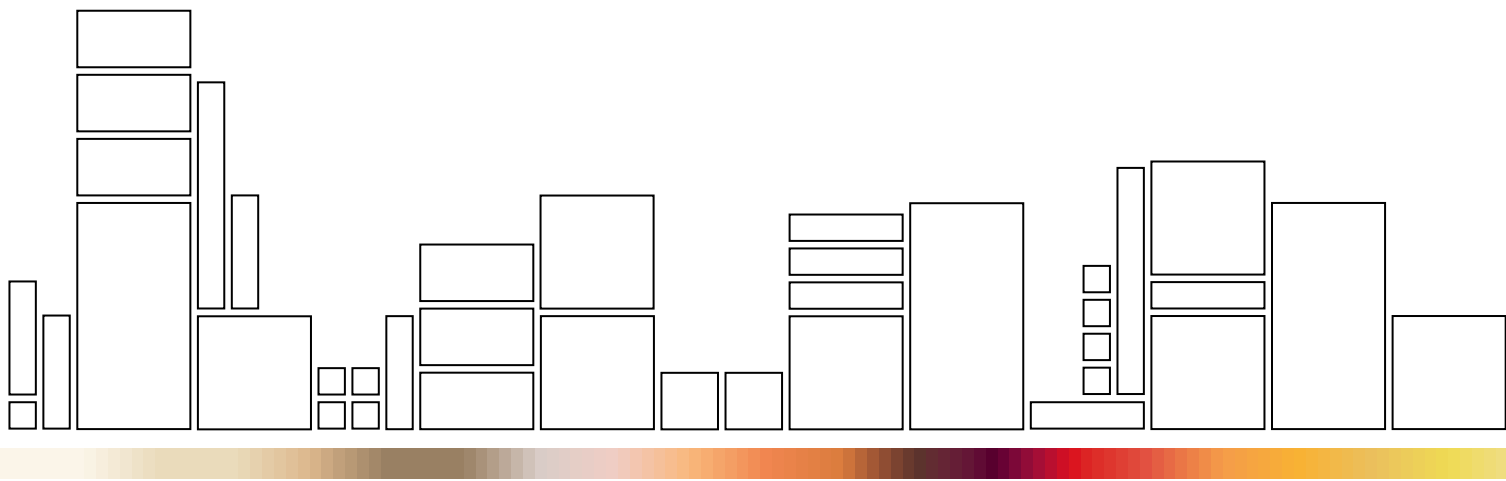



VOGUE Floor

Interni40
Flooring40 R10
Grip40 B (A+B)

Cos'è Vogue Floor

Vogue Floor raggruppa le serie Ceramica Vogue appositamente pensate per un uso a pavimento. Caratteristica comune alle serie è la capacità di coniugare un'estetica moderna ad alte prestazioni tecniche e di sicurezza, senza mai trascurare la necessità di garantire facilità di pulizia e di manutenzione. Praticità, funzionalità antiscivolo e originalità delle texture accomunano le linee Vogue Floor, tutte disponibili in una vasta gamma cromatica, adatte a ricoprire anche grandi superfici e utilizzabili in combinazione alle altre collezioni di Ceramica Vogue.

What is Vogue Floor

Vogue Floor groups together the Ceramica Vogue series specifically designed for floor use. A common denominator of the series is their ability to combine modern design with high technical performance and safety, without neglecting the need for easy cleaning and maintenance. The Vogue Floor ranges are practical, non-slip and with original textures, and come in a wide range of colours, suited for tiling large surfaces and in combination with the other Ceramica Vogue collections.

Was ist Vogue Floor

Zu Vogue Floor gehören die Serien von Ceramica Vogue, die speziell für den Einsatz als Bodenbelag bestimmt sind. Ein gemeinsames Merkmal der Serie ist die Fähigkeit, moderne Ästhetik mit hohen technischen Leistungen und Sicherheit zu kombinieren, ohne dabei die Notwendigkeit außen vor zu lassen, eine einfache Reinigung und Pflege zu gewährleisten. Zweckmäßigkeit, Funktionalität im Hinblick auf die Rutschhemmung und Trittsicherheit sowie die Originalität der Texturen verbinden sich mit einer umfassenden Farbauswahl. Die Fliesen von Vogue Floor sind zum Verlegen auf großen Flächen geeignet und können mit anderen Kollektionen von Ceramica Vogue kombiniert werden.

Qu'est-ce que Vogue Floor

Vogue Floor regroupe les séries Ceramica Vogue spécialement conçues pour une utilisation en tant que revêtements de sols. La caractéristique commune aux séries est la capacité d'allier une esthétique moderne aux hautes prestations en matière de technique et de sécurité, sans jamais négliger le besoin de garantir à la fois facilité de nettoyage et d'entretien. Commodité, fonction anti-dérapante et originalité des textures sont typiques des lignes Vogue Floor, toutes disponibles dans une vaste gamme chromatique, adaptées à revêtir aussi les grandes surfaces et utilisables en assortiment avec les autres collections de Ceramica Vogue.

Interni40

La superficie satinata e il grande formato per rivestire pavimentazioni elegantemente colorate. La gamma composta da 14 colori, derivati dal Vogue System, si presta anche ad un utilizzo a parete.

Large, satin-finish tiles for elegantly coloured floorings. The range, consisting of 14 colours based on the Vogue System, also lends itself for use on walls.

Die matte Oberfläche und das große Format zur eleganten Verkleidung farbiger Böden. Die Serie besteht aus 14 Farben des Vogue Systems und ist auch für Wände geeignet.

Surface satinée et grand format, c'est le carrelage idéal pour des sols colorés et élégants. La gamme se compose de 14 coloris, dérivés du Vogue System, et peut également être utilisée en tant que revêtement mural.

Floorin40 R10

Serie ideata con caratteristiche che coniugano l'aspetto estetico e quello tecnico antiscivolo (R10). Adatta per l'impiego in ambienti commerciali e residenziali.

Series designed to combine aesthetic and technical non-slip features (R10). Suitable for use in commercial and residential environments.

Die Serie vereint Ästhetik mit Rutschfestigkeit (R10). Für den Einsatz in privaten und gewerblichen Bereichen geeignet.

Série dont les caractéristiques allient esthétique et finition antidérapante (R10). Peut être utilisée dans des bâtiments commerciaux ou résidentiels.

Grip40 B (A+B)

Pensata per l'impiego a pavimento in zone con presenza di acqua. La caratteristica antiscivolo B (A+B) si presta in modo ottimale all'impiego nelle pavimentazioni circostanti le piscine.

Designed for use as flooring in wet areas. Its non-slip B characteristics (A + B) make it optimal for use as poolside flooring.

Für Böden in Nassbereichen. Durch die rutschhemmenden Eigenschaften B (A+B) eignet sich das Produkt hervorragend für Böden in Schwimmbadbereichen.

Conçue pour être posée au sol en présence d'eau, cette série présente l'avantage d'être antidérapante (A+B) et peut donc être utilisée autour des piscines.

Interni40 *superficie satinata satin-finish surface satinierter Oberfläche surface satinée*



Utilizzo: interni ed esterni, pavimenti e rivestimenti
 Use: internal and external, floor and wall tiling
 Einsatzbereich: Innen- und Außenbereiche, Bodenbeläge und Wandverkleidungen
 Utilisation: intérieurs et extérieurs, revêtements de sols et de murs

Formati
 Sizes
 Formate
 Formats

40x40
 16"x16"

0,85 cm

Flooring40 R10 *superficie antiscivolo satinata satin-finish non-slip surface satinierter, rutschfeste Oberfläche surface anti-dérapante*



Utilizzo: interni ed esterni, pavimenti - R10
 Use: internal and external, floors - R10
 Einsatzbereich: Innen- und Außenbereiche, Bodenbeläge - R10
 Utilisation: intérieurs et extérieurs, revêtements de sols - R10

Formati
 Sizes
 Formate
 Formats

40x40
 16"x16"

0,85 cm

Grip40 B (A+B) *superficie antiscivolo satinata satin-finish non-slip surface satinierter, rutschfeste Oberfläche surface anti-dérapante*



Utilizzo: interni ed esterni, pavimenti - B (A+B)
 Use: internal and external, floors - B (A+B)
 Einsatzbereich: Innen- und Außenbereiche, Bodenbeläge - B (A+B)
 Utilisation: intérieurs et extérieurs, revêtements de sols - B (A+B)

Formati
 Sizes
 Formate
 Formats

40x40
 16"x16"

0,85 cm

IN - Interni40

RF - Flooring40 R10

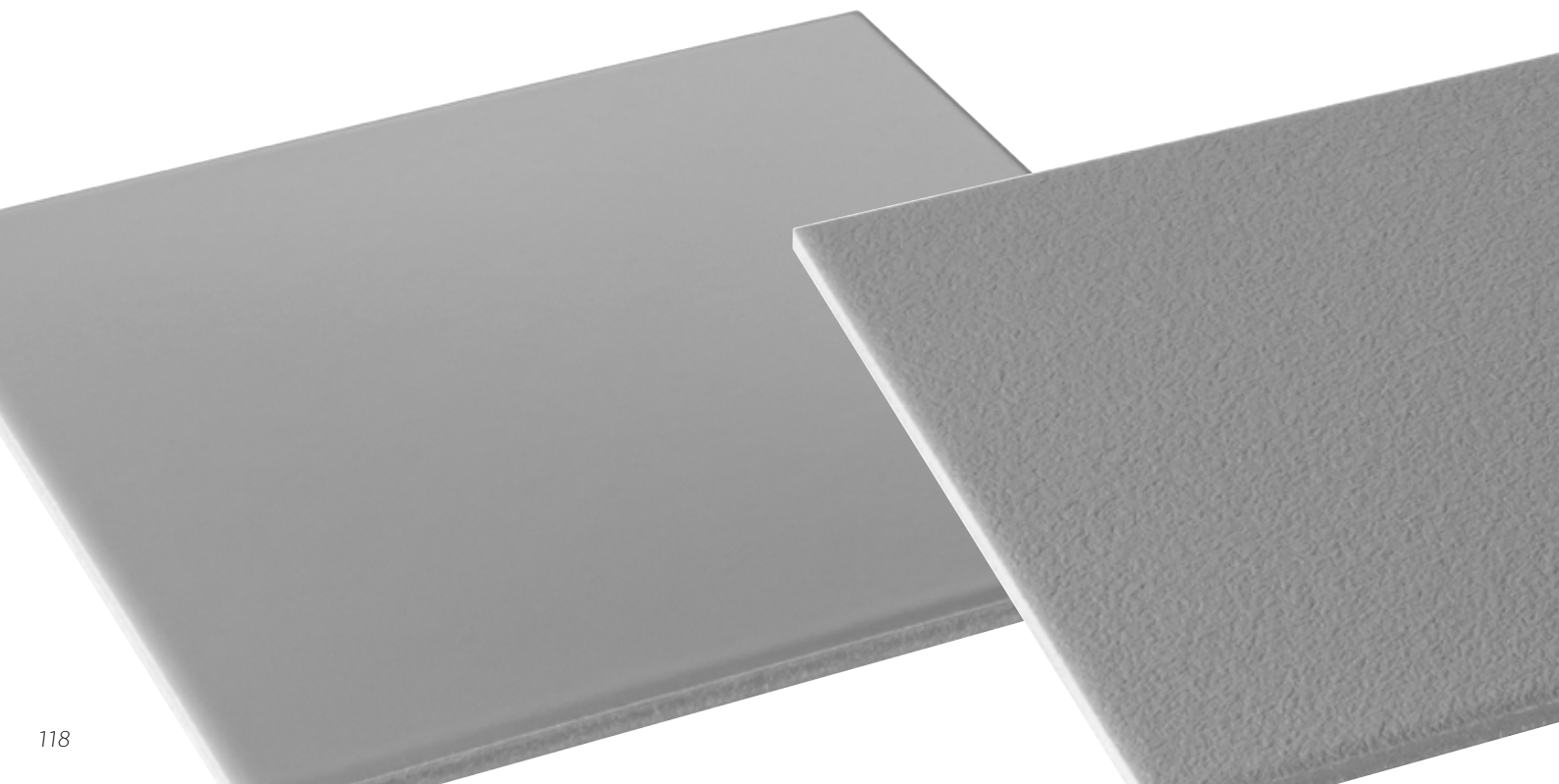



IN argento



IN ferro



IN nero

satinée



RF oltremare



RF argento



RF grigio



RF ferro



RF nero

satinée

IG - Grip40 B (A+B)



IN ghiaccio

P.E.I. ④



40x40 cm

IN latte

P.E.I. ④



40x40 cm

IN seta

P.E.I. ④



40x40 cm

IN nocciola

P.E.I. ②



40x40 cm

IN caffè

P.E.I. ①



40x40 cm

IN mandarino

P.E.I. ③



40x40 cm

IN pompelmo

P.E.I. ④



40x40 cm

IN pistacchio

P.E.I. ④



40x40 cm

IN oliva

P.E.I. ②



40x40 cm

IN azzurro

P.E.I. ④



40x40 cm

IN oltremare

P.E.I. ②



40x40 cm

IN argento

P.E.I. ③



40x40 cm

IN ferro

P.E.I. ②



40x40 cm

IN nero

P.E.I. ①



40x40 cm

Utilizzo: interni ed esterni, pavimenti e rivestimenti
 Use: internal and external, floor and wall tiling
 Einsatzbereich: Innen- und Außenbereiche, Bodenbeläge und Wandverkleidungen
 Utilisation: intérieurs et extérieurs, revêtements de sols et de murs

Formati
 Sizes
 Formate
 Formats

40x40 }
 16"x16" } $\frac{\nabla}{\blacktriangle} 0,85 \text{ cm}$

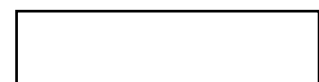

9,5x40
 3 1/4"x16"

Battiscopa
 Skirting
 Sockelleiste
 Plinthe

RF ghiaccio

P.E.I. ④

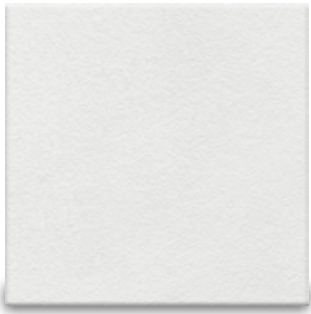

40x40 cm

RF seta

P.E.I. ④



40x40 cm

RF tortora

P.E.I. ③



40x40 cm

RF rosso

P.E.I. ③



40x40 cm

RF mandarino

P.E.I. ③



40x40 cm

RF giallo

P.E.I. ③



40x40 cm

RF menta

P.E.I. ①



40x40 cm

RF turchese

P.E.I. ②



40x40 cm

RF laguna

P.E.I. ④



40x40 cm

RF azzurro

P.E.I. ④



40x40 cm

RF blu avio

P.E.I. ③



40x40 cm

RF oltremare

P.E.I. ②



40x40 cm

RF argento

P.E.I. ④



40x40 cm

RF grigio

P.E.I. ③



40x40 cm

RF ferro

P.E.I. ②



40x40 cm

RF nero

P.E.I. ①



40x40 cm

Utilizzo: interni ed esterni, pavimenti - R10
 Use: internal and external, floors - R10
 Einsatzbereich: Innen- und Außenbereiche, Bodenbeläge - R10
 Utilisation: intérieurs et extérieurs, revêtements de sols - R10

Formati
 Sizes
 Formate
 Formats

40x40
 16"x16"

} $\frac{\nabla}{\blacktriangle}$ 0,85 cm

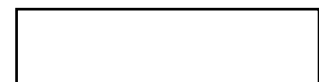

9,5x40
 3 1/4"x16"

Battiscopa - disponibile nella finitura *Interni*
 Skirting - available in *Interni* finishes
 Sockelleiste - verfügbar in der Ausführung *Interni*
 Plinthe - disponible dans la finition *Interni*

IG ghiaccio

P.E.I. ④



40x40 cm

IG seta

P.E.I. ④



40x40 cm

IG tortora

P.E.I. ③



40x40 cm

IG argento

P.E.I. ④



40x40 cm

IG grigio

P.E.I. ③



40x40 cm

Utilizzo: interni ed esterni, pavimenti - B (A+B)
 Use: internal and external, floors - B (A+B)
 Einsatzbereich: Innen - und Außenbereiche, Bodenbeläge - B (A+B)
 Utilisation: intérieurs et extérieurs, revêtements de sols - B (A+B)

Formati
 Sizes
 Formate
 Formats

40x40
 16"x16"

} $\frac{\nabla}{\blacktriangle} 0,85 \text{ cm}$



9,5x40
 3 1/4"x16"

Battiscopa - disponibile nella finitura *Interni*
 Skirting - available in *Interni* finishes
 Sockelleiste - verfügbar in der Ausführung *Interni*
 Plinthe - disponible dans la finition *Interni*

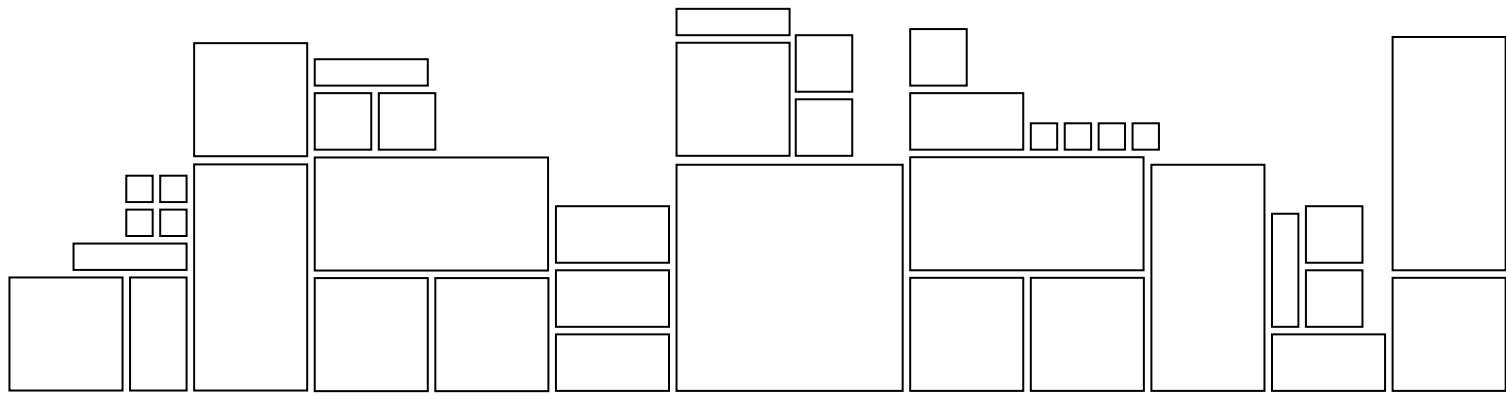

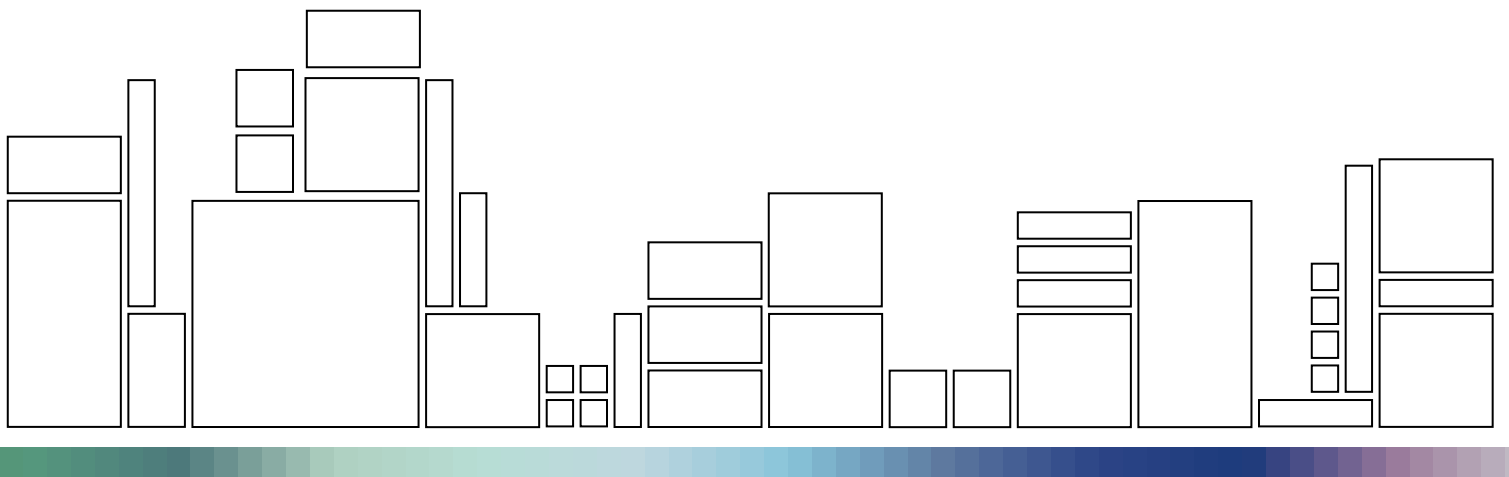

VOGUE Pool

Bump C (A+B+C) V6

Special Pool

Cos'è Vogue Pool

La collezione Vogue Pool offre prodotti e pezzi speciali appositamente studiati per la progettazione e realizzazione di piscine. A completamento della proposta, la collezione Vogue System, per il rivestimento delle vasche, nelle finiture satinata, lucide e antiscivolo R10 B (A+B) e R11 C (A+B+C), la collezione Vogue Link per creare piacevoli decorazioni sia a pavimento che a rivestimento e la collezione Vogue Floor disponibile in una vasta gamma cromatica nel formato 40x40 adatta anche a pavimentazioni tecniche R10 e B(A+B).

What is Vogue Pool

Vogue Pool is a collection of products and special pieces specifically designed for the creation and installation of swimming pools. The range is completed by the Vogue System collection of products for tiling pool tanks, available in satin, glossy and non slip finishes R10 B (A+B) and R11 C (A+B+C), the Vogue Link collection of attractive decorations for both floors and walls and the Vogue Floor collection available in a vast range of colours in the 40x40 size, also ideal for technical flooring R10 and B(A+B).

Was ist Vogue Pool

Die Kollektion Vogue Pool bietet Produkte und Formteile, die speziell für die Planung und Errichtung von Schwimmbecken entwickelt wurden. Ergänzt wird dieses Angebot durch die Kollektion Vogue System für die Verkleidung von Schwimmbecken in der satinierten, glänzenden und rutschhemmenden Ausführung R10 B (A+B) und R11 C (A+B+C), die Kollektion Vogue Link für die Gestaltung von angenehmen Dekorationen auf den Böden und Wandverkleidungen sowie die Kollektion Vogue Floor, die in einer breiten Farbpalette im Format 40x40 erhältlich ist, das auch für technische Fußböden geeignet ist R10 und B (A+B).

Qu'est-ce que Vogue

La collection Vogue Pool propose des produits et des pièces spéciales expressément conçus pour la conception et la réalisation de piscines. Pour le revêtement des bassins, dans les finitions satinée, polie et antidérapante R10 B (A+B) et R11 C (A+B+C), la collection Vogue System complète cette proposition. La collection Vogue Link a été conçue pour créer d'agréables décors aussi bien sur les sols que sur les murs, et la collection Vogue Floor existe en une vaste gamme chromatique en 40x40 dont les caractéristiques s'adaptent aussi aux sols techniques R10 et B (A+B).

Bump C (A+B+C) V6

Superficie strutturata da tratti lineari che garantiscono un grado di antiscivolosità - gruppo C (A+B+C) - a piedi nudi. Prodotto ideale per il rivestimento di bordi vasca, lava piedi, zone di virata, gradini in presenza di acqua.

The textured surface has linear markings, guaranteeing group C (A+B+C) category skid-resistance with bare feet. An ideal product for tiling pool surrounds, footbaths, turning pads, and steps under- or close to water.

Strukturierte Oberfläche mit geraden Linien, die einen hohen Rutschhemmungsgrad - Gruppe C (A+B+C) - in Barfußbereichen gewährleisten. Das ideale Produkt für die Verkleidung von Schwimmbeckenbereichen, Fußbecken, Wendebereichen und Stufen, die nass sein können.

Surface structurée par des traits linéaires assurant un degré d'antiglissance - groupe C (A+B+C) - pieds nus. Produit idéal pour le revêtement des margelles des bassins, des lave-pieds, des zones de virage, des marches en présence d'eau.

Special Pool

Una gamma di pezzi speciali appositamente studiati per realizzare la maggior parte dei bordi vasca, prodotti anche con lunghezza 10 cm per offrire la soluzione ottimale anche in presenza di profili di vasca curvilinei.

A range of special pieces designed specifically to cater for the majority of pool surrounds, products even with lengths of 10 cm to offer the ideal solution even for curved pool edges.

Eine Palette an Formteilen, die speziell für die Verwirklichung des Großteils der Beckenränderarten entwickelt wurden und auch mit 10 cm Länge produziert werden, um auch bei kurvenförmigen Beckenprofilen die optimale Lösung zu bieten.

Une gamme de pièces spéciales expressément conçues pour réaliser la plupart des margelles des bassins, produites aussi en 10 cm de long pour proposer la solution la meilleure même en présence de supports curvilignes.

Bump C (A+B+C) V6

superficie antiscivolo strutturata structured skid resistant surface rutschfeste strukturierte



BP ghiaccio



BP seta



BP turchese



BP laguna



BP cielo



BP cobalto



BP grigio

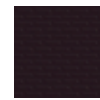

BP nero

Utilizzo: interni ed esterni, pavimenti - C (A+B+C) V6

Use: internal and external, floors - C (A+B+C) V6

Einsatzbereich: Innen - und Außenbereiche, Bodenbeläge - C (A+B+C) V6

Utilisation: intérieurs et extérieurs, revêtements de sols - C (A+B+C) V6

Formati
Sizes
Formate
Formats

10x20
4'x8" } 0,7 cm

Special Pool

superficie antiscivolo strutturata structured skid resistant surface rutschfeste strukturierte



cod. BR ghiaccio

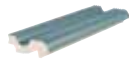

cod. BR turchese



cod. BR cobalto



cod. BR nero

Utilizzo: interni ed esterni

Use: internal and external

Einsatzbereich: Innen - und Außenbereiche

Utilisation: intérieurs et extérieurs

Formati
Sizes
Formate
Formats

6,3x20
2½'x8"



cod. BC ghiaccio



cod. BC turchese



cod. BC cobalto



cod. BC nero

Utilizzo: interni ed esterni

Use: internal and external

Einsatzbereich: Innen - und Außenbereiche

Utilisation: intérieurs et extérieurs

Formati
Sizes
Formate
Formats

10x20
4'x8"

BP - Bump C (A+B+C) V6

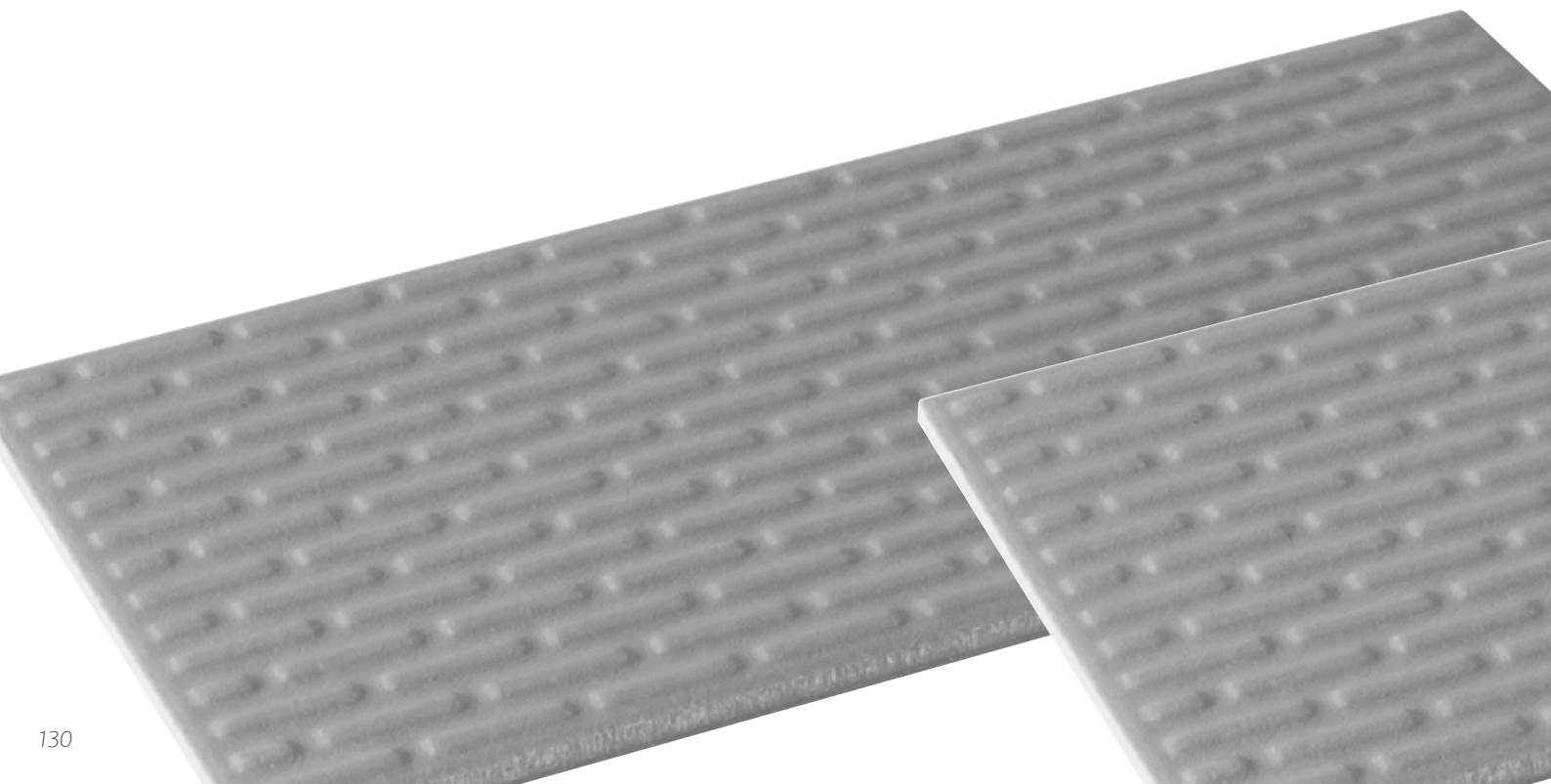

Oberfläche surface antidérapante structurée

Oberfläche surface antidérapante structurée



cod. FU ghiaccio cod. FU turchese cod. FU cobalto cod. FU nero

Utilizzo: interni ed esterni

Use: internal and external

Einsatzbereich: Innen - und Außenbereiche

Utilisation: intérieurs et extérieurs, revêtements de sols

Formati
Sizes 4,5x20
Formate 1¾x8"
Formats

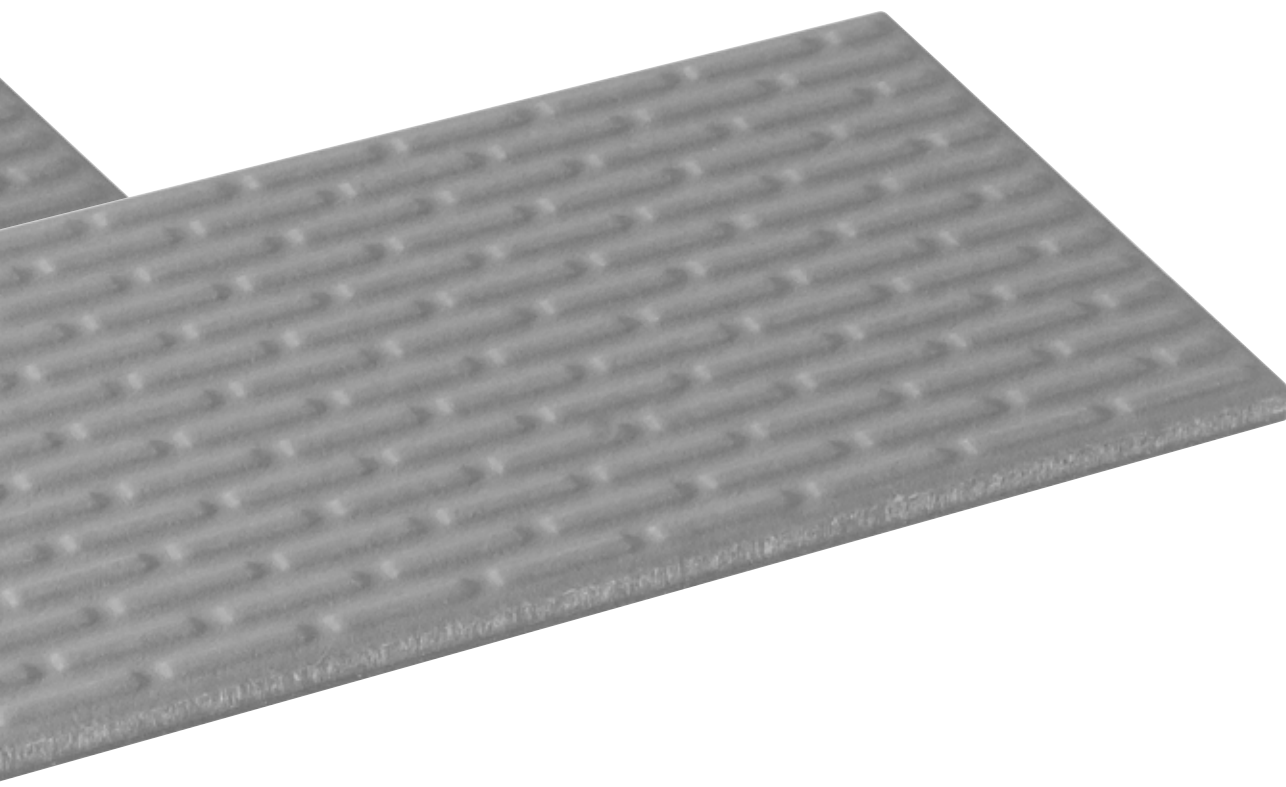

BP ghiaccio

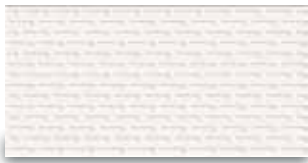

10x20 cm

BP seta

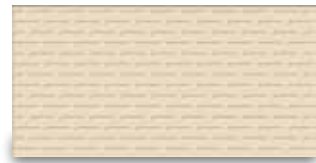

10x20 cm

BP turchese



10x20 cm

BP laguna



10x20 cm

BP cielo

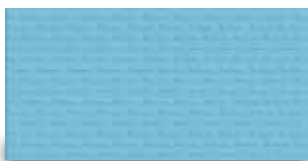

10x20 cm

BP cobalto



10x20 cm

BP grigio



10x20 cm

BP nero



10x20 cm

Utilizzo: interni ed esterni, pavimenti - C (A+B+C) V6

Use: internal and external, floors - C (A+B+C) V6

Einsatzbereich: Innen - und Außenbereiche, Bodenbeläge - C (A+B+C) V6

Utilisation: intérieurs et extérieurs, revêtements de sols - C (A+B+C) V6

Formati
Sizes
Formate
Formats

10x20 }
4'x8" } $\frac{\nabla}{\blacktriangle}$ 0,7 cm

cod. BC ghiaccio

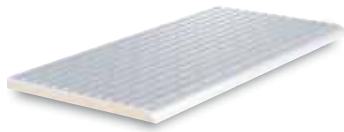

10x20 cm

cod. BR ghiaccio



6,3x20 cm

cod. FU ghiaccio



4,5x20 cm

cod. BC turchese

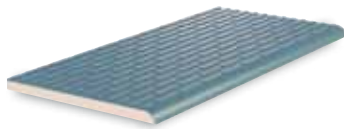

10x20 cm

cod. BR turchese

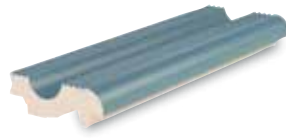

6,3x20 cm

cod. FU turchese

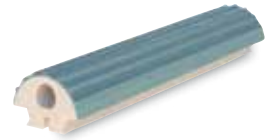

4,5x20 cm

cod. BC cobalto

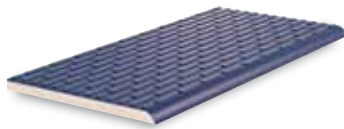

10x20 cm

cod. BR cobalto



6,3x20 cm

cod. FU cobalto

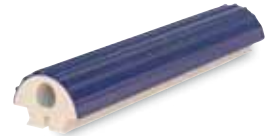

4,5x20 cm

cod. BC nero

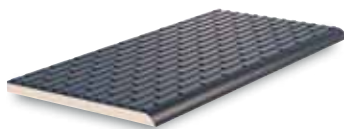

10x20 cm

cod. BR nero



6,3x20 cm

cod. FU nero

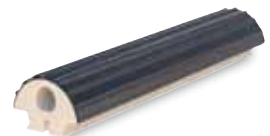

4,5x20 cm

Utilizzo: interni ed esterni
 Use: internal and external
 Einsatzbereich: Innen - und Außenbereiche
 Utilisation: intérieurs et extérieurs

Formati
 Sizes
 Formate
 Formats

Cod. BC 10×20 $\left. \begin{array}{l} 4' \times 8'' \\ \hline \end{array} \right\} \begin{array}{l} \nabla \\ \hline \end{array} 0,7 \text{ cm}$

Cod. BR $6,3 \times 20$ $\left. \begin{array}{l} 2\frac{1}{2}' \times 8'' \\ \hline \end{array} \right\} \begin{array}{l} \nabla \\ \hline \end{array} 2,2 \text{ cm}$

Cod. FU $4,5 \times 20$ $\left. \begin{array}{l} 1\frac{3}{4}' \times 8'' \\ \hline \end{array} \right\} \begin{array}{l} \nabla \\ \hline \end{array} 3 \text{ cm}$

Sistema Finlandese Finnish system System Finland Système Finlandais

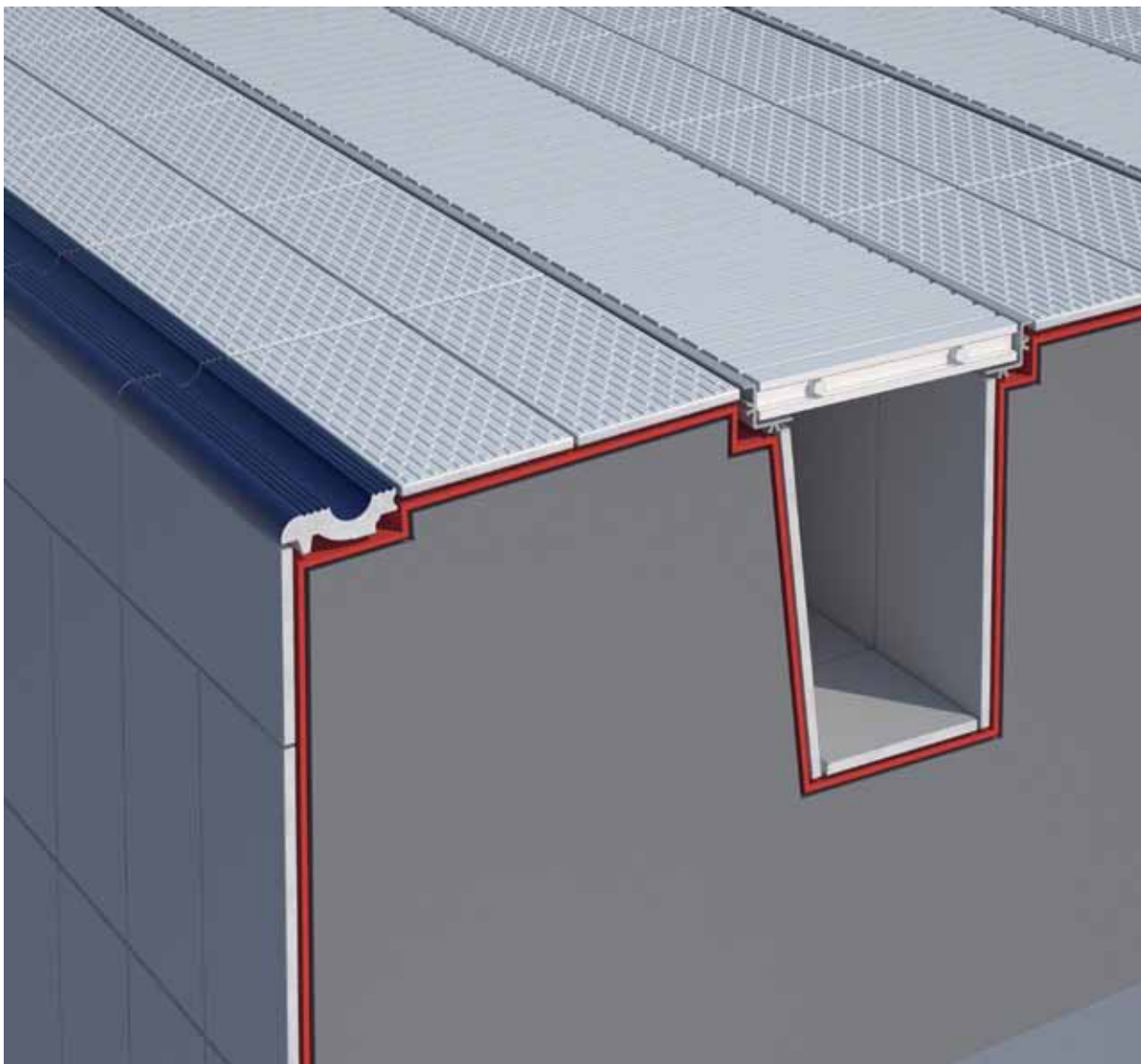

1. cod. BR 6,3x20

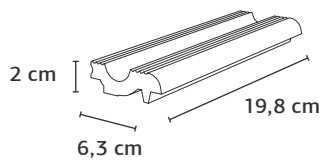

2. BP 10x20

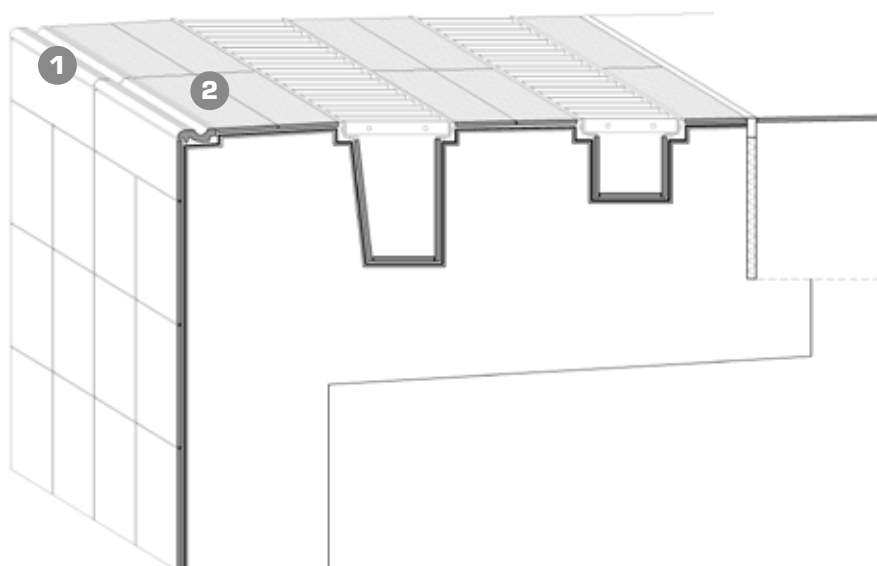
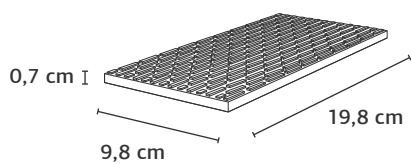

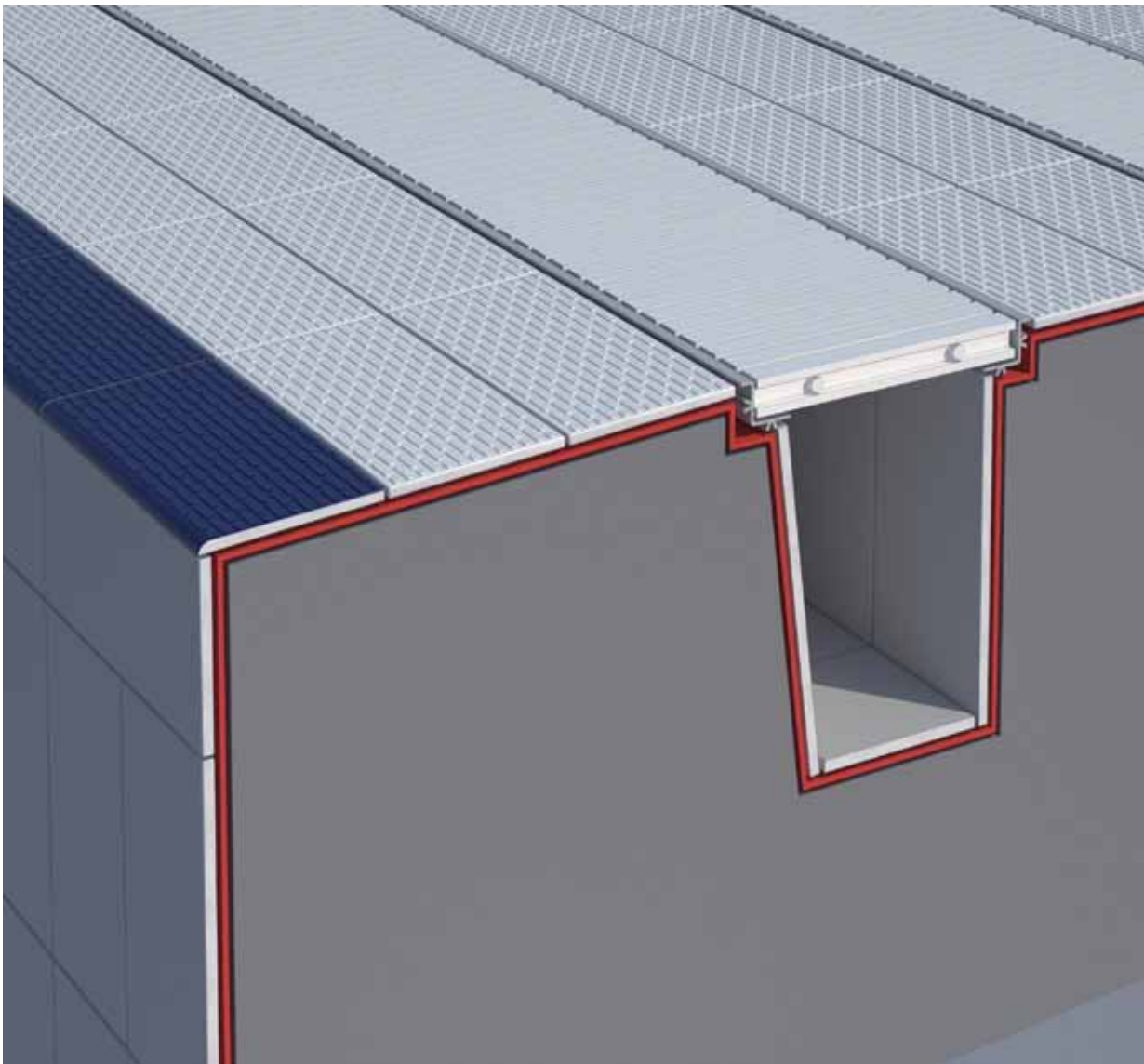

1. cod. BC 10x20

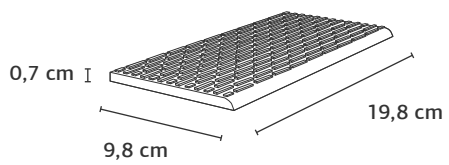

2. BP 10x20

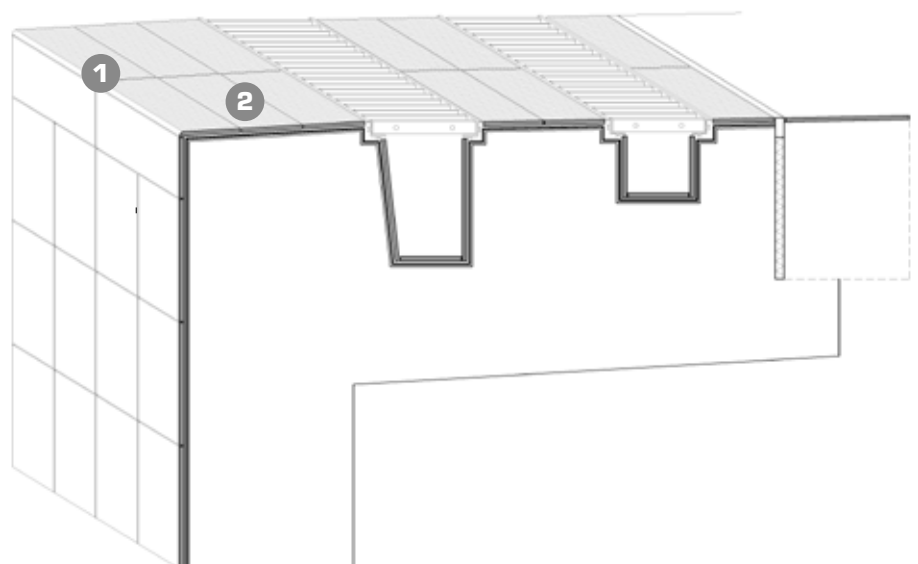
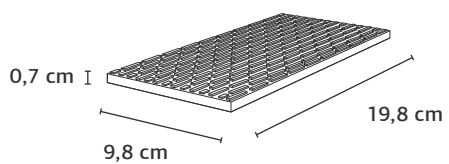

Sistema Zurigo Zurich system System mit Züricher Rinne Système Zurich

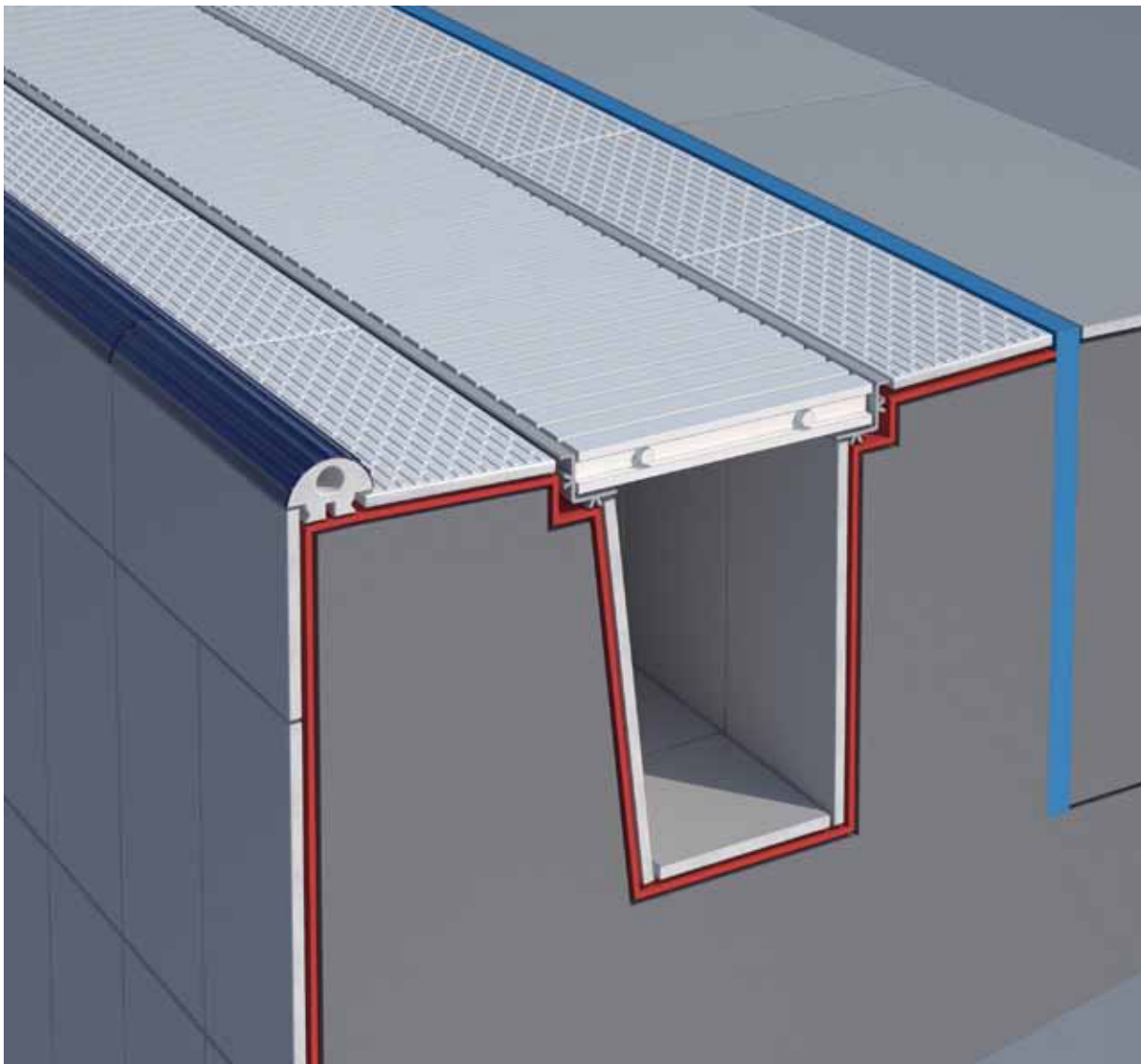

1. cod. FU 4,5x20

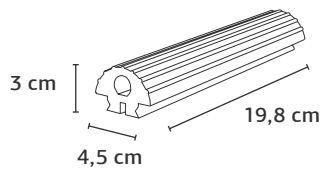

2. BP 10x20

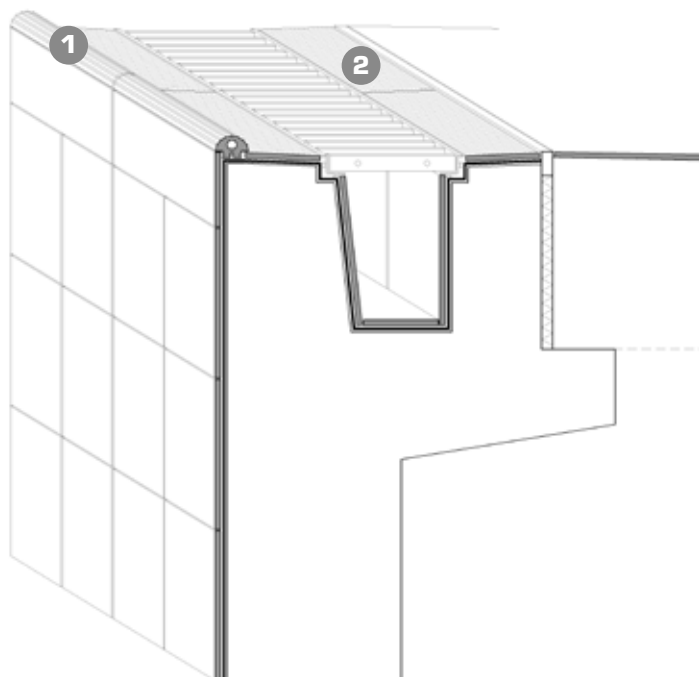
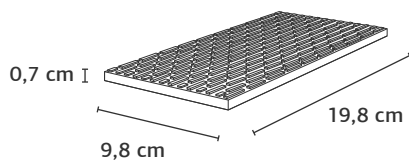



1. cod. B 10x10

Vogue System (p. 25)

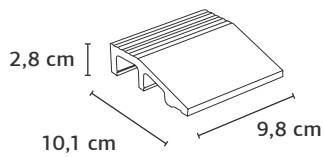

2. BP 10x20

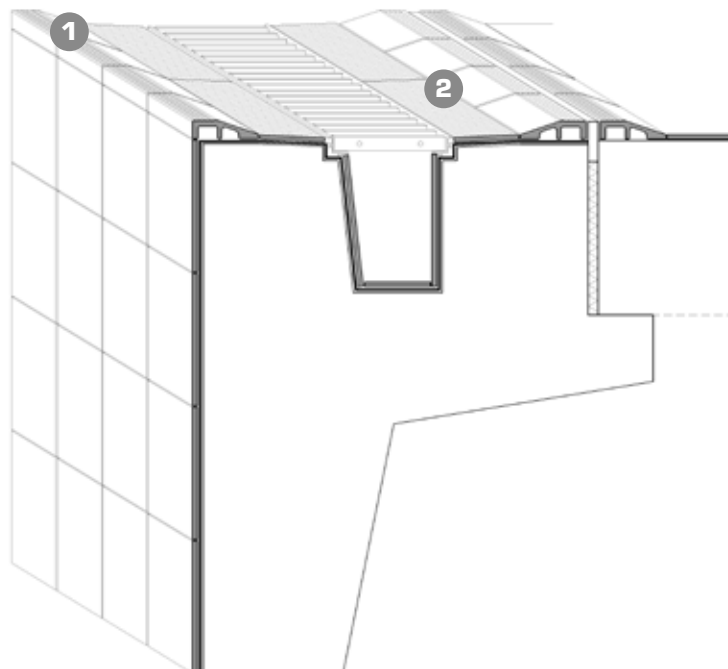
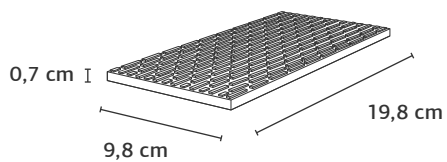

Sistema Skimmer Skimmer system Skimmer-System Skimmer ou écumeur de surface

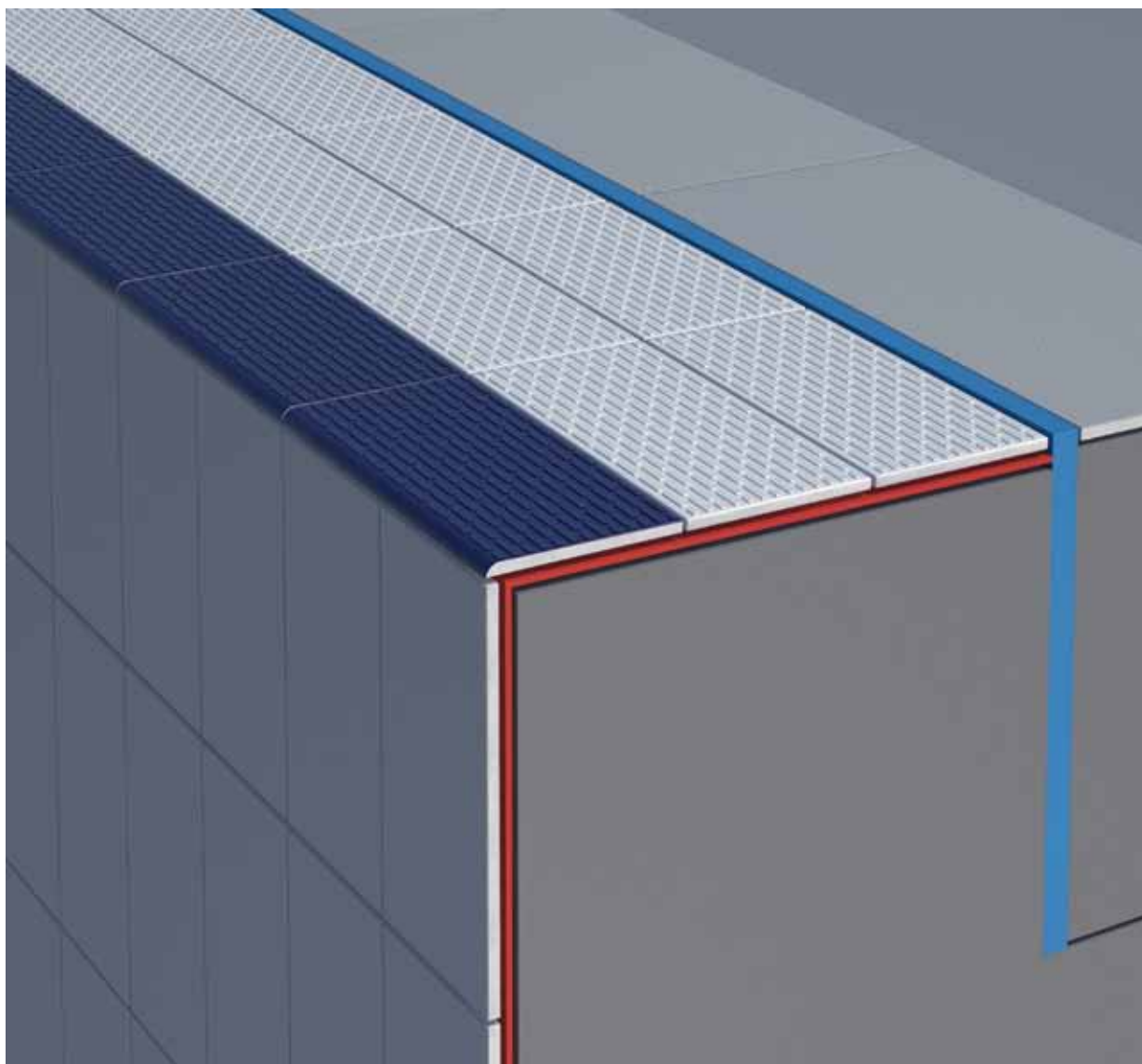

1. cod. BC 10x20

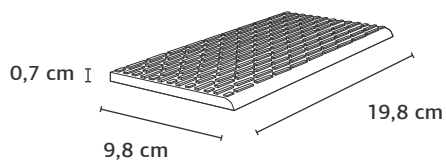

2. BP 10x20

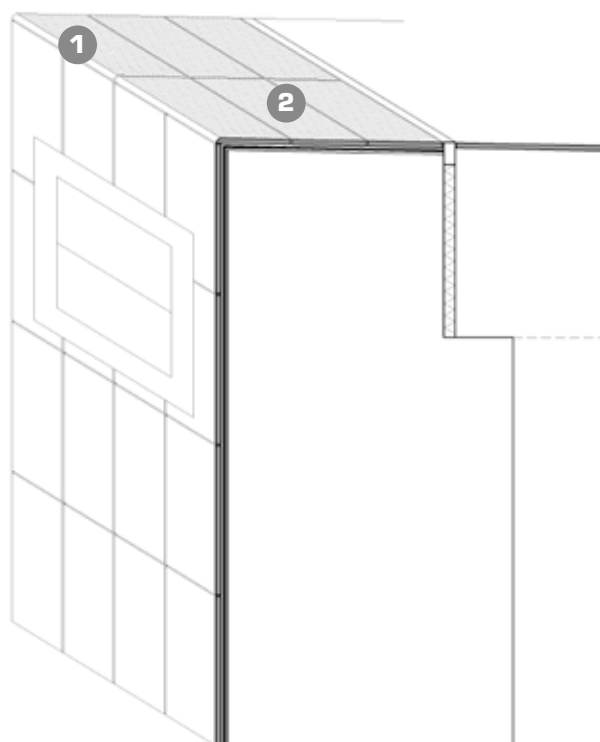
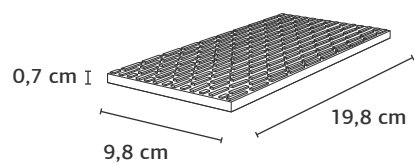

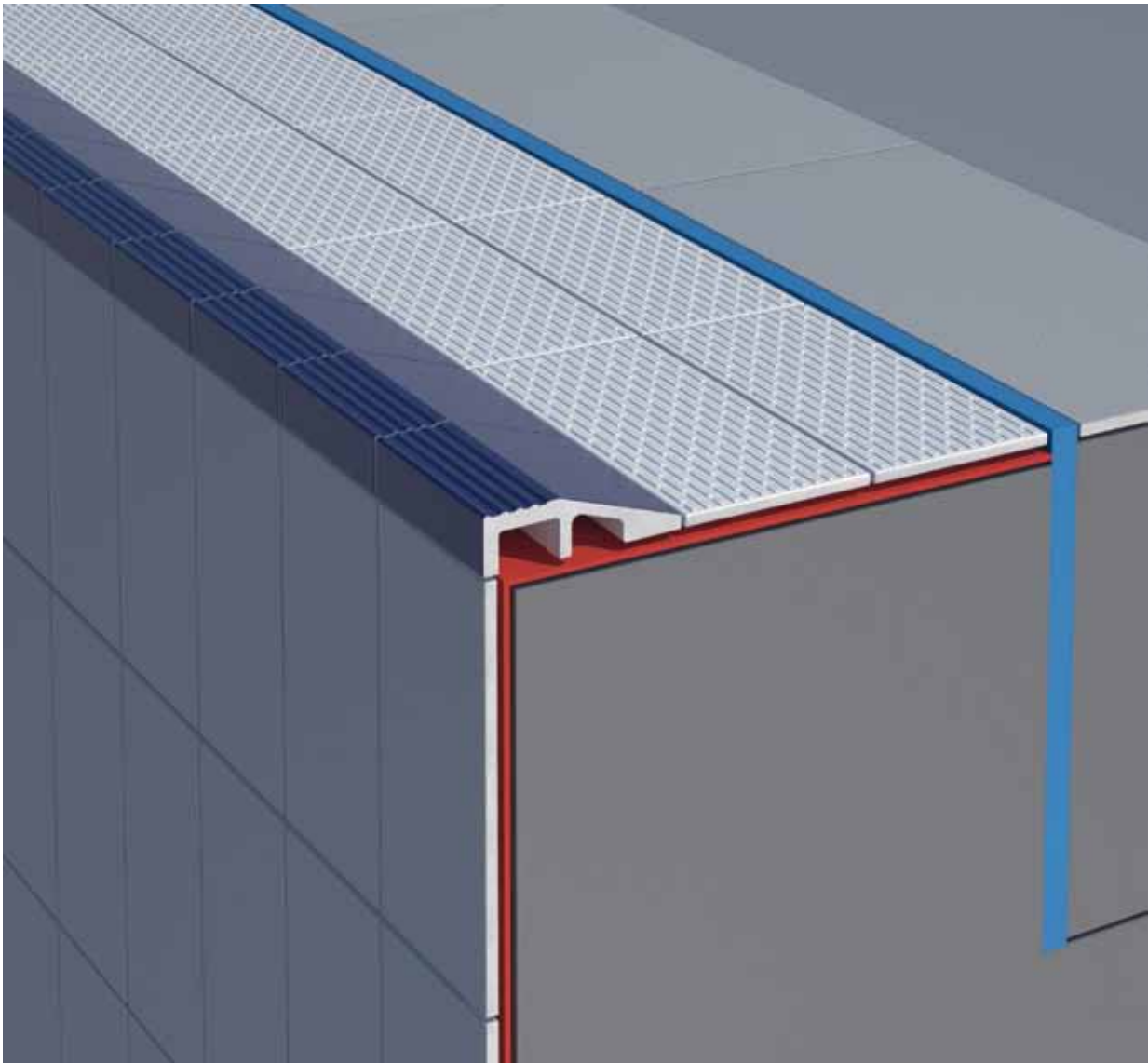

1. cod. B 10x10

Vogue System (p. 25)

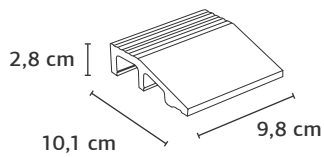

2. BP 10x20

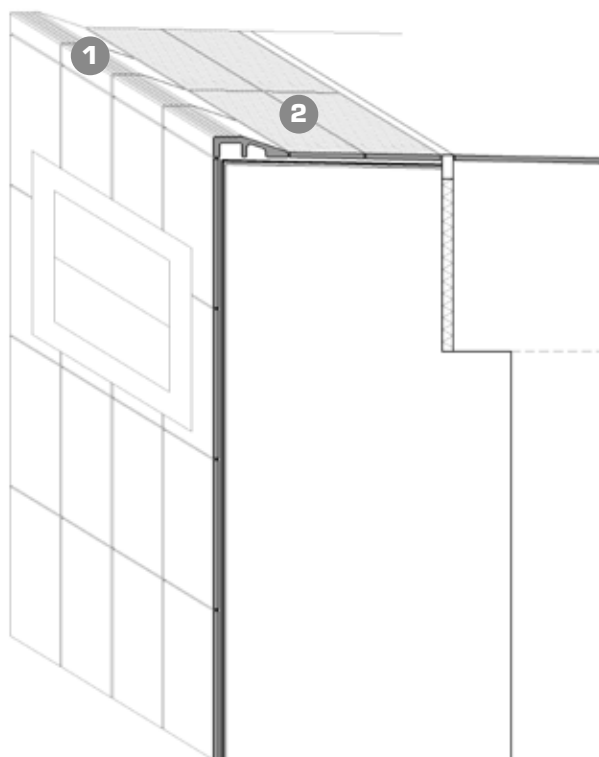
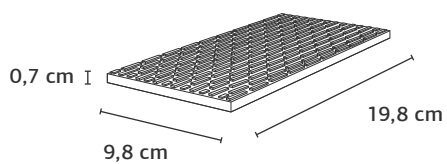

Gradino di riposo Resting step Sitzstufen Marche de repos

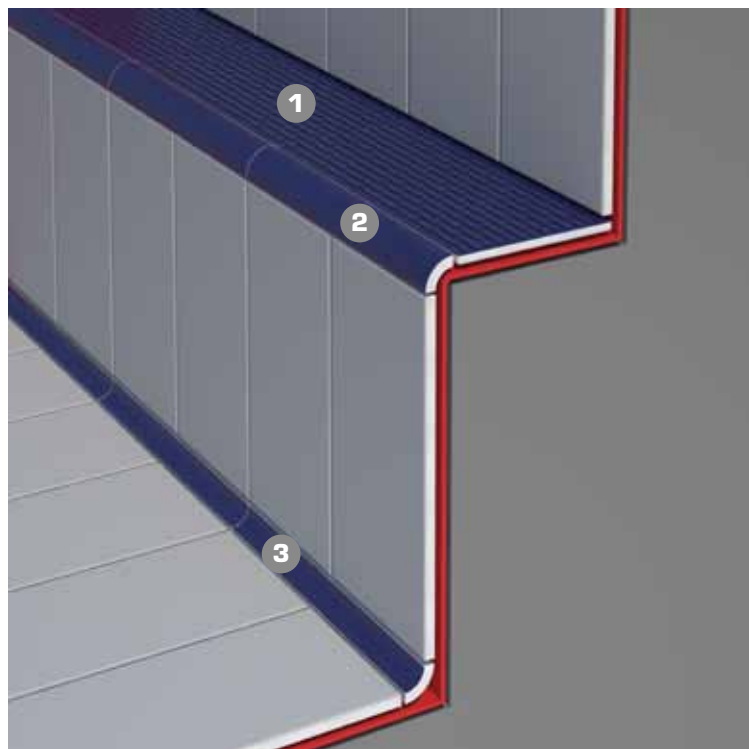

1. BP 10x20

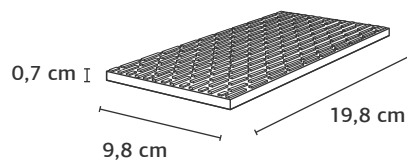

2. cod. N 2,5x20

Vogue System (p. 25)

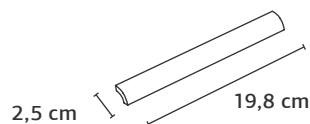

3. cod. M 2,5x20

Vogue System (p. 25)

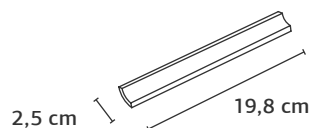

Scala e gradini Ladder and steps Treppe und Stufen Escalier et marches

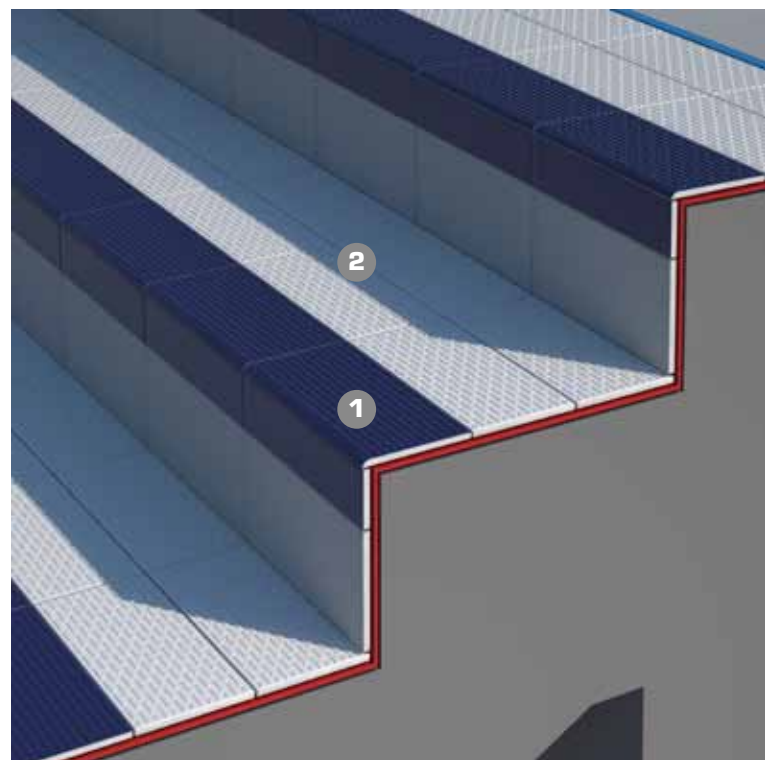

1. cod. BC 10x20

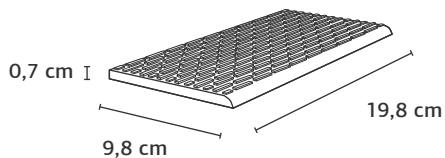

2. BP 10x20

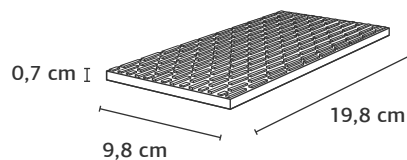

Muretto Wall kleine Mauer Muret



1. BP 10x20

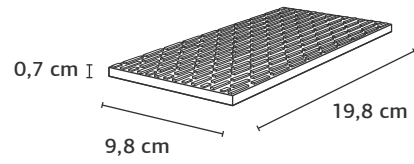

2. cod. K 2,5x10

Vogue System (p. 25)

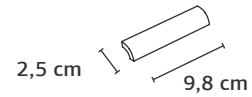

3. cod. F 2,5x2,5

Vogue System (p. 25)

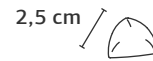

4. cod. N 2,5x20

Vogue System (p. 25)

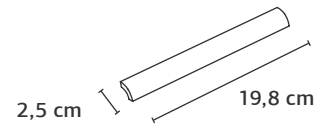

Referenze

References

Referenzen

Références

Biblioteca S.M.S. Luigi Lombardi
Bari (BA) - Italy
Project: ma0/Studio d'architettura









Collegio Universitario San Paolo Einaudi
Torino (TO) - Italy
Project: arch. Luca Moretto



Asilo Nido Girotondo

Piacenza (PC) - Italy

Project: FA+FB Fabio Boiardi Filippo Armani architetti







Residenza privata
Viserbella (RN) - Italy
Project: Area 52 Studio di Progettazione



Negozi Camper
di Londra, Glasgow e Genova
Project: Tomás Alonso Design Studio







Chostro della Pace
Università di Fisciano

Salerno (SA) - Italy

Project: arch. Ettore Sotsass, arch. Marco Palmieri



Istituto Alberghiero Pellegrino Artusi
Riolo Terme (RA) - Italy
Project: Studio Rava Piersanti architetti

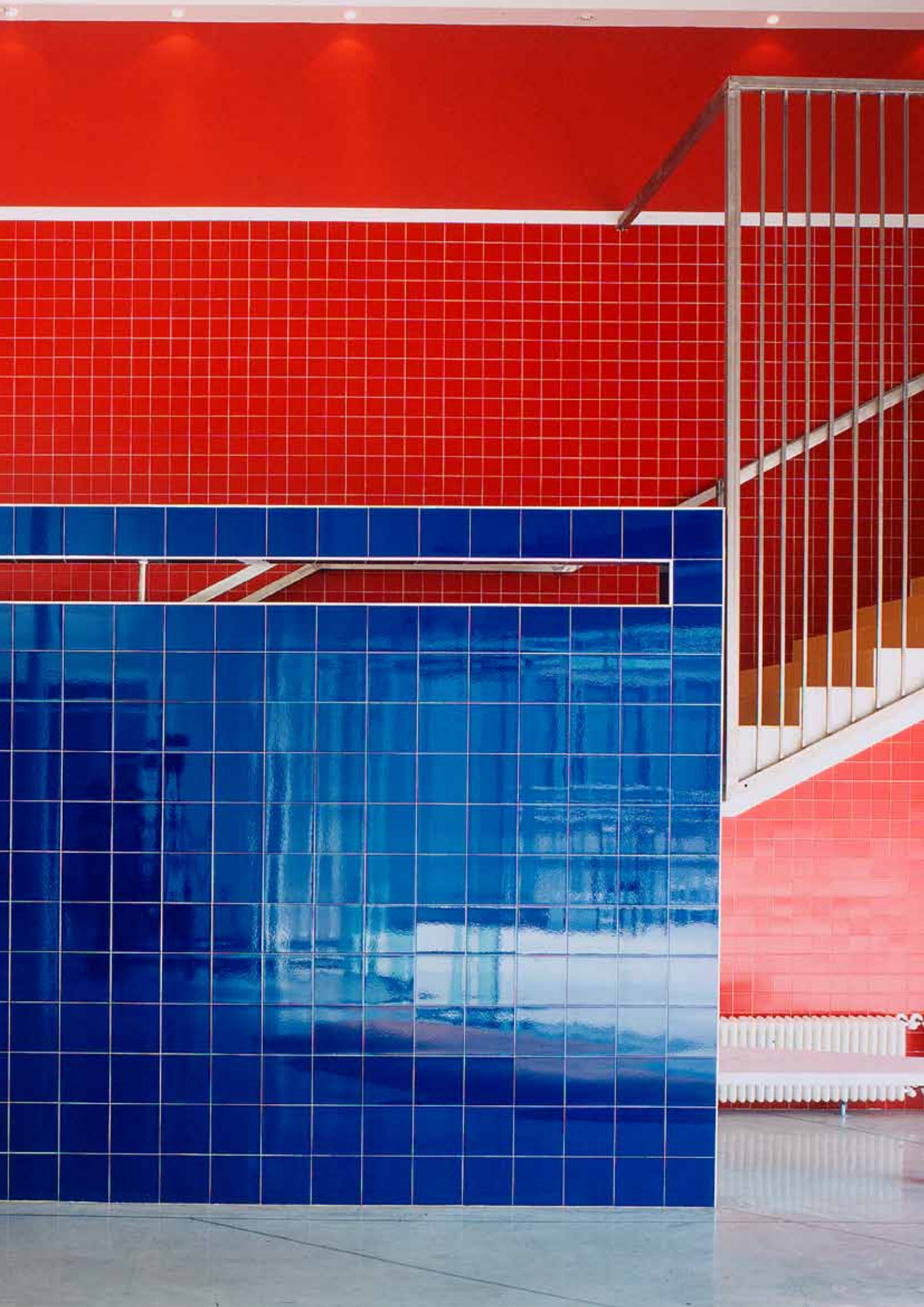





Azienda Ospedaliera Universitaria Meyer
Ospedale Pediatrico
Firenze (FI) - Italy
Project: CSPE (Centro Studi Progettazione Edilizia)



Centro di riabilitazione funzionale
Fisio&Lab Italia
Torino (TO) - Italy
Project: arch. Monia Pecchio







Collegio Universitario Crocetta Einaudi
Torino (TO) - Italy
Project: arch. Luca Moretto



Scuola Materna S. Giuseppe
Peraga di Vigonza (PD) - Italy
Project: Studio B.A. - Ing. Baratto Enzo







Palazzine per uffici Metro Complex
Milano (MI) - Italy
Project: arch. David Dydek



Torri Garibaldi
Sede Maire Tecnimont

Milano (MI) - Italy

Project: Progetto CMR – arch. Massimo Roj









Residenza Casa Maggio
Casa di Riposo Orfanelle Città di Chieri
Chieri (TO) - Italy
Project: arch. Carmen Restuccia



Hotel Poseidon

Torre del Greco (NA) - Italy

Project: Studio ELT Stefano Esposito, Fabiana Longo,
Rosa Troja - Studio d'architetti associati







Aquapark
UherskéHradiště - CzechRepublic
Project: Saura Development Solutions



Hippopotamus Restaurant Grill – Budapest Airport
Budapest - Hungary
Project: T-W Interiors Kft.



NEGRONI

pizza · pasta · panini







Sede Assicurazione Allianz
Budapest - Hungary
Project: Schüller és Társai Építésziroda Kft. / Schüller
Ferenc



C. C. "Centro Sicilia"- Iperspar
Catania (CT) - Italy
Project: Design International



Offerta
FORMAGGIO
ASIAGO TA
€ 0.69

TAKE AWAY
FRESCHIZIAE QUALITÀ

Offerta
EMMENTALER
SUIZZERO TA
€ 0.79

Offerta
PROVOLONE PICCOLA
PIRELLA
€ 0.99

0.15 1.00 1.40 0.60 0.70 0.80 0.90





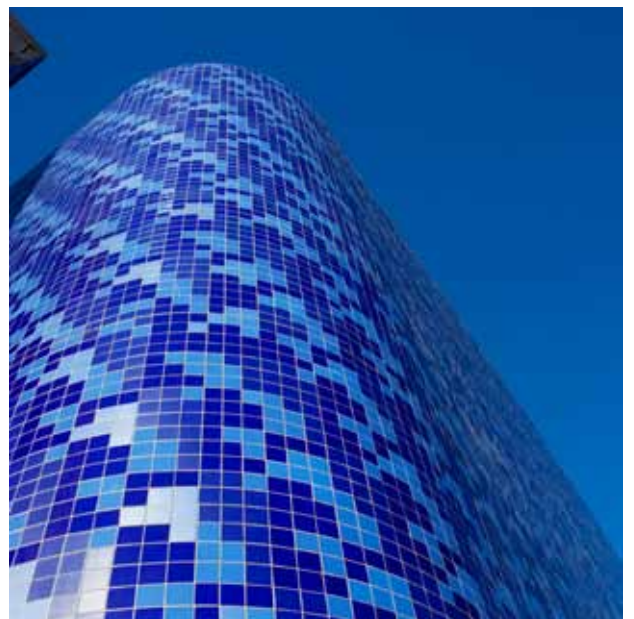

Soweto Theatre
Johannesburg - South Africa
Project: Afritects



Casa dei Bambini Scuola Montessori
Milano (MI) - Italy
Color project: Francesca Valan







Rep. pediatria Ospedale Causa Pia Luvini
Cittiglio (VA) - Italy
Project: Il Ponte del Sorriso Onlus



American International School
Budapest - Hungary
Project: A+A Stúdió Kft. Annus Ferenc



Ospedali, assistenza Hospitals, Health Assistance Krankenhäuser, Betreuung Hôpitaux, assistance

Castle Peak Hospital (Hong Kong) | Groupe Hospitalier Pitie Salpetriere, Paris (Francia) | IOMI Istituto Ortopedico Mezzogiorno Italia, Ganzirri (ME) | Ospedale Benesov (Rep. Ceca) | Ospedale, Gallipoli (LE) | Ospedale, Swidnica (Polonia) | Senior Citizen at Jordan Valley, casa di riposo (Hong Kong) | Casa di riposo A. Galvan (PD) | Polo Pediatrico Meyer Firenze (FI) | Clinica Veterinaria Città di Bari Bari (BA) | Centro riabilitazione funzionale Fizio&Lab Italia Torino (TO) | Casa Maggio - Casa di riposo della Città di Chieri, Chieri (TO) | Seniorenheim, Ergolsbach (Germania) | Reparto Pediatria Ospedale Causa Pia Luvini – Cittiglio (VA)

Istruzione e cultura Education and culture Bildung und Kultur Instruction et culture

Bibliothèque de Lille (Francia) | Crumling High School/Jerry Loughery Archs (Irlanda del Nord) | FIU, Miami University, Miami (USA) | Mensa Universitaria Pisa (PI) | Opera House, Oslo (Norvegia) | Palazzo Grassi (VE) | Sede Scuola Gambero Rosso Roma (RM) | South Cambridge District School/Aucklets (Regno Unito) | Teatro La Fenice Venezia (VE) | Università di Bressanone (BZ) | Università di Fisciano (SA) | West London Academy/Foster & Partners (Regno Unito) | Asilo Nido Girotondo Piacenza (PC) | Biblioteca S.M.S. Luigi Lombardi Bari (BA) | Collegio Universitario San Paolo Einaudi Torino (TO) | Collegio Universitario Crocetta Einaudi (TO) | Scuola di danza Open Dance Center Milano (MI) | Istituto Alberghiero Pellegrino Artusi Riolo Terme (RA) | Scuola Materna “S. Giuseppe”, Paraga di Vigenza (PD) | Acquario, Cattolica (RN) | Casa dello Studente Firenze (FI) | Chiostro della Pace Università di Fisciano Salerno (SA) | Soweto Theatre –Johannesburg (South Africa) | Casa dei Bambini Scuola Montessori Milano (MI) | American International School Budapest (Hungary)

Residenziale Residential Haushalt Résidentiel

Waterside Apartments, Kinsale (Irlanda) | Wohnpark,Westerland/Sylt (Germania) | Selvaag Bygg AS, Oslo (Norvegia) | Shatin 2B residential towers (Hong Kong) | Tai Koo Valley site V – residential towers (Hong Kong)

Ospitalità Hospitality Gästeunterbringung Hospitalité

Circolo Nautico Ruggiero di Lauria (PA) | Club Med (All over the world) | Complesso Alimini Otranto (LE) | Hayatt Hotel, Varsavia (Polonia) | Hotel Cosmopolitan Terme, Ischia (NA) | Hotel Le Ruote Cadeo (PC) | Hotel Logoav Park/Broadway Maylan/Algarve (Portogallo) | Hotel Porro, Salsomaggiore Terme (PR) | Hotel Royal Casino-Sofitel, Mandeleu-la-Napoule (Francia) | Hotel Schmidt, Adelsried (Germania) | Hotels Eurodisney (Francia) | St. Joseph Society Center, Mill Hills Father (Irlanda) | Sporthotel, Waregem (Belgio) | Struttura alberghiera a Gioiosa Marea (ME) | Villaggio Turistico La Madonnina Follonica (GR) | Villaggio turistico Valle di Mare (SR) | Grand Hotel Salerno (SA) | NAVALIS hotel bathrooms in Klaipeda (Lithuania) | Casa dei Servi della Sofferenza (Padre Pio), S. Giovanni Rotondo (FG)

Fitness-salute-sport Fitness-Health-Sports Fitness-Gesundheit-Sport Fitness-santé-sport

Hilton Hotel, piscina, Praga (Rep. Ceca) | Hotel Gem, piscina e spogliatoi, Wroclaw (Polonia) | Hotel Stadion, Fitness Center, Budapest (Ungheria) | Hyatt Hotel, Swimming Pool, Dead Sea (Israele) | Star Hotel Swimming Pool, Sidney (Australia) | Centre Sportif Aqua Club Val Thorens (Francia) | Centro Benessere Tropos (FI) | Centro CONI Tirrenia (PI) | Changing Rooms Formosa Auckland (Nuova Zelanda) | Club Mediterranée (All over the world) | Coleraine Sports Pavilion (Irlanda del Nord) | Dolphins Stadium, Miami (USA) | Erlebnisbad, Bonn (Germania) | Exerzizien-Haus, Werdenfels (Germania) | Fonte del benessere, centro fitness Siracusa (SR) | Golf Club Cattolica (RN) | Heilbachlandschaft, Bad Kissingen (Germania) | Kurbad, Bad Ems (Germania) | New Wembley Stadium/Foster & Partners (Regno Unito) | Nowa Gdynia – Lodz, spogliatoi piscine (Polonia) | Palestra Le Club Piacenza (PC) | Palestra Kontakt Soffiano (FI) | Piscina Delfino, Avola (SR) | Piscina, Pioermel (Francia) | Thalassotherapie, Carnac (Francia) | Zodiac Palestre Firenze (FI) | Centro Ravviva S.c.s. Torino (TO) | Aquapark Uherske Hradiste, Rep.Ceca | Piscina Opole (Polonia) | Piscina Suwalki, Polonia | LIKENAI sanatorium swimming-pool in Likenai (Lithuania)

Commerciali Commercial Verkauf Commerciaux

Auchan Bari (BA) | Auchan Budapest (Ungheria) | Auchan Casa Massima (BA) | Auchan, località Melilli (SR) | Auchan, Mesagne (BR) | Auchan, Modugno (BA) | Champion (All over the world) | Carrefour (All over the world) | Coop Codis (Olanda) | Danish Supermarket (Danimarca) | IGA (Canada) | IKA Supermarket (Svezia) | Interspar, catena supermercati (Rep. Ceca) | IperCoop (PC) | Monoprix (All over the world) | Panorama (RM) | Pizza Hut (All over the world) | Sobey's (Canada) | MyChef (All over the world) | McDonald (tutt'Italia) | Innscor food chain, Africa | RIMI supermarket chain in Lithuania (Latvia & Estonia) | IKEA exposition boxes in Vilnius, (Lithuania) | IKEA exposition boxes in Espoo, Finland | LA CREPE, creperie restaurant in Vilnius (Lithuania) | RŪTA chocolate factory in Šiauliai (Lithuania) | Hippopotamus Restaurant Grill – Budapest Airport Budapest (Hungary) | C.C. "Centro Sicilia" Iperspar Catania (CT)

Varie Miscellaneous Verschiedenes Divers

Aéroport de Bâle/(Svizzera-Francia) | Autogrill (tutt'Italia) | Banca Popolare di Sondrio, Lugano (Svizzera) | BBC – Fit Out and Base Building/Pringle Brandon & McCorman Jamieson (UK) | Belfast Royal Courts (Irlanda del Nord) | Bundesbahn, Regensburg (Germania) | Centre de Loisir Plascese, Isneauville (Francia) | Centre Immobilier Pierre et Vacances (Francia) | Cinema Multisala Lecce (LE) | City Quay Offices, Dublin (Irlanda) | Cucina e Sala mensa Regione Lazio (RM) | Exhibition Building, Oslo (Norvegia) | Fiera di Bologna (BO) | Filiale Mercedes Benz- Smart (RM) | Filiali Renault (RM) | Hala Sazka – Praga (Rep. Ceca) | Iceland Parliament, Reykjavik (Islanda) | Ind. Farmaceutica Eli Lilly Italia S.p.A Sesto Fiorentino (FI) | Manchester Magistrate Courts/Gensler (Regno Unito) | Metro Station, Schiedam (Olanda) | Mokarabia Coffee Bar (tutt'Italia) | Muro a mosaico in P.zza Borgo Dora Torino (TO) | One North Wacker Tower, Chicago (USA) | Porto Turistico "Marina Cala De' Medici", Castiglioncello (LI) | Prinz. Leopold-Kaserne, Regensburg (Germania) | Pump Station, Los Angeles California (USA) | Queen Elisabeth 2, Cruiseship/ SMC Design (Regno Unito) | Salon Volvo, Varsavia (Polonia) | Sede Empoli Calcio, Empoli (FI) | Shell Office Building, Copenhagen (Danimarca) | Stazion Metro, Rennes (Francia) | Stekljeni Dvor, uffici, Ljubljana (Slovenia) | Telekomunikacija, Varsavia (Polonia) | T+R Autobahnraststätte, Irschenberg (Germania) | Uffici Ferrovie di Stato (RM) | Uffici Mediaset, Sottopasso Stazione Ferroviaria Sopot (Polonia) | Aeroporto Linate zona arrivi Milano (MI) | Palazzine per uffici Metro Complex Milano (MI) | Torri Garibaldi Sede Maire Tecnimont Milano (MI) | Sede Assicurazione Allianz Budapest (Hungary) | Terme di Caracalla (RM) | Uffici R.A.I. in Via di Grottarossa (RM)

Schede Tecniche

Technical Charts
Technische Informationen
Fiches Techniques

Voci di capitolato Tender specifications Ausschreibungstext Detail des appels d'offre

Piastrelle di ceramica pressate a secco con basso assorbimento di acqua ($0,5\% < E_b \leq 3\%$)

Gruppo B1_b - M - GL EN 14411:2012 appendice H.

Glazed ceramic tiles, dry pressed with low water absorption ($0,5\% < E_b \leq 3\%$)

Group B1_b - M - GL EN 14411:2012 H appendix.

Keramische glasierte Fliesen, trockengepresst, geringer Wasseraufnahme ($0,5\% < E_b \leq 3\%$)

Gruppe B1_b - M - GL EN 14411:2012 H Anhang.

Carreaux ceramiques émaillés, pressés à sec à faible absorption d'eau ($0,5\% < E_b \leq 3\%$)

Groupe B1_b - M - GL EN 14411:2012 annexe H.

Commenti:

La modularità e le caratteristiche dimensionali delle piastrelle Ceramica Vogue presentano valori decisamente migliorativi rispetto alle prescrizioni delle norme, che ottimizzano il risultato estetico riducendo al contempo i costi di posa. Vogue è un prodotto facile da posare. I test relativi alle proprietà chimiche confermano che i prodotti di Ceramica Vogue forniscono prestazioni elevate per quanto riguarda la facilità di manutenzione, resistenza alle macchie, igienicità. In caso di particolari esigenze relative alla resistenza chimica, sono disponibili, a richiesta, test specifici.

Remarks:

Modularity and dimensional characteristics of the Ceramica Vogue ceramic tiles are definitely over the prescriptions of the norms, enhancing the aesthetical effect and reducing at the same time the laying costs. The Vogue product is easy to lay. The tests about chemical properties confirm high performances of the Ceramica Vogue products concerning an easy maintenance, resistance to stains, hygienic conditions. In case of particular requests concerning the chemical resistance, specific tests are available on demand.

Hinweise:

Die Modularität sowie die charakteristischen Dimensionen der Ceramica Vogue fliesen sind hochwertig und übersteigen die erforderlichen Normwerte, optimieren das esthetische Verlegebild und sind nicht so verlegkostenintensiv. Voguefliesen sind einfach zu verlegen! Die Prüfungsergebnisse der Säureteste bestätigen daß die Ceramica Vogue eine hohe Resistenz gegen Flechenbildung aufweist und somit einfach in der Pflege, Reinigung und Hygiene ist. Sofern besondere Eigenschaften hinsichtlich divv. chemischen Reaktionen gefordert werden, liegen auf Abruf, spezielle Testergebnisse vor.





Commentaires:

La modularité et les caractéristiques dimensionnelles des carreaux Ceramica Vogue présentent des valeurs nettement au-dessus des prescriptions des normes, afin d'optimiser le résultat esthétique en réduisant en même temps les coûts de pose. Vogue est donc un produit facile à poser. Les tests relatifs aux propriétés chimiques confirment que Ceramica Vogue donne prestations élevées pour ce qui concerne la facilité d'entretien, résistance aux taches, hygiène. Pour des nécessités spécifiques aux résistances chimiques, sont disponibles les tests spécifiques sur demande



Dimensioni e qualità della superficie Dimensions and surface quality
 Abmessungen und Qualität der Oberfläche Dimensions et qualité de la surface

formato nominale nominal shape Nennmaße format nominal	dimensione di fabbricazione actual size effektive Maße format réel	metodo di prova test methods Pruefverfahren méthods d'essai	requisiti requirements Anforderungen exigences		risultati Vogue Vogue results Vogue Ergebnisse résultats Vogue	
5x5 cm	lati - sides - Seiten - cotés: 48,1x48,1 mm	EN ISO 10545-2			lati - sides Seiten - cotés:	± 0,3 mm
	spessore - thickness - Stärke - épaisseur: 7 mm				spessore - thickness Stärke - épaisseur:	± 0,4 mm
5x20 cm	lati - sides - Seiten - cotés: 48,1x198,4 mm	EN ISO 10545-2	lati - sides Seiten - cotés:	± 0,6%	lati - sides Seiten - cotés:	± 0,3%
	spessore - thickness - Stärke - épaisseur: 7 mm		spessore - thickness Stärke - épaisseur:	± 5%	spessore - thickness Stärke - épaisseur:	± 4%
5x40 cm	lati - sides - Seiten - cotés: 48,1x398,8 mm	EN ISO 10545-2	lati - sides Seiten - cotés:	± 0,6%	lati - sides Seiten - cotés:	± 0,3%
	spessore - thickness - Stärke - épaisseur: 8,5 mm		spessore - thickness Stärke - épaisseur:	± 5%	spessore - thickness Stärke - épaisseur:	± 4%
10x10 cm	lati - sides - Seiten - cotés: 98,2x98,2 mm	EN ISO 10545-2	lati - sides - Seiten cotés - lados:	± 0,9 mm	lati - sides Seiten - cotés:	± 0,3 mm
	spessore - thickness - Stärke - épaisseur: 7 mm		spessore - thickness Stärke - épaisseur:	± 0,5 mm	spessore - thickness Stärke - épaisseur:	± 0,4 mm
10x20 cm	lati - sides - Seiten - cotés: 98,2x198,4 mm	EN ISO 10545-2	lati - sides Seiten - cotés:	± 0,6%	lati - sides Seiten - cotés:	± 0,3%
	spessore - thickness - Stärke - épaisseur: 7 mm		spessore - thickness Stärke - épaisseur:	± 5%	spessore - thickness Stärke - épaisseur:	± 4%
20x20 cm	lati - sides - Seiten - cotés: 198,4x198,4 mm	EN ISO 10545-2	lati - sides Seiten - cotés:	± 0,6%	lati - sides Seiten - cotés:	± 0,3%
	spessore - thickness - Stärke - épaisseur: 7 mm		spessore - thickness Stärke - épaisseur:	± 5%	spessore - thickness Stärke - épaisseur:	± 4%
20x40 cm	lati - sides - Seiten - cotés: 198,4x398,8 mm	EN ISO 10545-2	lati - sides Seiten - cotés:	± 0,6%	lati - sides Seiten - cotés:	± 0,3%
	spessore - thickness - Stärke - épaisseur: 8,5 mm		spessore - thickness Stärke - épaisseur:	± 5%	spessore - thickness Stärke - épaisseur:	± 4%
40x40 cm	lati - sides - Seiten - cotés: 398,8x398,8 mm	EN ISO 10545-2	lati - sides Seiten - cotés:	± 0,6%	lati - sides Seiten - cotés:	± 0,3%
	spessore - thickness - Stärke - épaisseur: 8,5 mm		spessore - thickness Stärke - épaisseur:	± 5%	spessore - thickness Stärke - épaisseur:	± 4%
Rettilineità dei lati (superficie di esercizio) - Straightness of sides (working surface) - Geradheit der Seiten (Betriebsfläche) - Côtés rectilignes (surface d'utilisation)		EN ISO 10545-2	± 0,5%		± 0,4%	
Ortogonalità - Squareness - Rechtwinkligkeit - Angularité		EN ISO 10545-2	± 0,5%		± 0,4%	
Planarità della superficie - Flatness - Ebenflächigkeit - Planitude		EN ISO 10545-2	± 0,5%		± 0,4%	
Qualità della superficie - Surface quality - Oberflächenbeschaffenheit - Qualité de la surface		EN ISO 10545-2	min. 95%		min. 95%	



Proprietà fisiche Physical properties Physikalische Eigenschaften Propriétés physiques

prova test Prüfungen essai	metodo di prova test methods Pruefverfahren méthods d'essai	requisiti requirements Anforderungen exigences	risultati Vogue Vogue results Vogue Ergebnisse résultats Vogue
 Massa d'acqua assorbita (%) - Water absorption (%) Wasseraufnahme (%) - Masse d'eau absorbée (%)	EN ISO 10545-3	$0,5\% < E_b \leq 3,0\%$	2,5 % (escluso pezzi speciali e bisello - trims and bisello excepted ausser Formstücke und Bisello - à l'exception des pièces spéciales et bisello)
 Resistenza di rottura Tensile strength Bruchfestigkeit Résistant aux ruptures	spessore - thickness - Stärke épaisseur: $\geq 7,5$ mm	EN ISO 10545-4	1.100 N min.
	spessore - thickness - Stärke épaisseur: $< 7,5$ mm	EN ISO 10545-4	700 N min.
 Modulo di rottura - Modulus of rupture - Biegefestigkeit - Module de rupture	EN ISO 10545-4	30 N/mm ² min.	> 40 N/mm ²
 Resistenza all'abrasione (P.E.I.) - Abrasion resistance (P.E.I.) - Abriebbeständigkeit (P.E.I.) - Résistance à l'abrasion (P.E.I.)	EN ISO 10545-7	riportare la classe di abrasione - quote the abrasion class - geben Sie die Abnutzung Kategorie - donner la classe d'abrasion	vedi pagina prodotto - refer to product page - siehe Produktseite - voir page produit
 Coefficiente di dilatazione termica lineare Coefficient of linear thermal expansion - Lineare Wärmeausdehnungskoeffizient - Coefficient de dilatation thermique linéaire	EN ISO 10545-8	metodo di prova disponibile test method available Prüfverfahren vorhanden méthode d'essai disponible	$< 5 \times 10^{-6} / ^\circ\text{C}$
 Resistenza agli sbalzi termici - Thermal shock resistance Temperaturwechselbeständigkeit - Résistance aux chocs thermiques	EN ISO 10545-9	metodo di prova disponibile test method available Prüfverfahren vorhanden méthode d'essai disponible	garantita - granted - garantiert - garantie
 Resistenza al cavillo - Crazing resistance Haarissbeständigkeit - Résistance au tressailage	EN ISO 10545-11	richiesta - required - gefordert demandé	garantita - granted - garantiert - garantie
 Resistenza al gelo - Frost resistance - Frostbeständigkeit Résistance au gel	EN ISO 10545-12	metodo di prova disponibile test method available Prüfverfahren vorhanden méthode d'essai disponible	garantita (escluso pezzi speciali, bisello) - granted (trim, bisello pieces excepted) - garantiert (ausser Formstücke, Bisello) garantie (à l'exception des pièces spéciales, bisello)
 Dilatazione dovuta all'umidità - Expansion to humidity Ausdehnung bei Feuchtigkeit - Dilatation à l'humidité	EN ISO 10545-10	metodo di prova disponibile test method available Prüfverfahren vorhanden méthode d'essai disponible	< 0,04%
 Resistenza all'urto - Impact resistance Impaktbeständigkeit - Résistance au choc	EN ISO 10545-5	metodo di prova disponibile test method available Prüfverfahren vorhanden méthode d'essai disponible	> 0,6 (vedi appendice P) - (see P appendix) - (sehen Sie P Anhang) - (voir l'annexe P)



Proprietà chimiche Chemical properties Chemische Eigenschaften Propriétés chimiques

prova test Prüfungen essai	metodo di prova test methods Pruefverfahren méthods d'essai	requisiti requirements Anforderungen exigences	risultati Vogue Vogue results Vogue Ergebnisse résultats Vogue
 Resistenza alle macchie - Stain resistance - Fleckenbeständigkeit Résistance aux taches	EN ISO 10545-14	classe 3 min.	3 min. (vedi appendice P) - (see P appendix) - (sehen Sie P Anhang) - (voir l'annexe P)
 Resistenza ai prodotti chimici d'uso domestico ed agli additivi per piscina - Resistance to chemical products for housekeeping and to the additives used in swimming-pools - Beständigkeit gegen Hausreinigungsmittel und gegen die in Schwimmbecken verwendeten chemischen Zusätze - Résistance aux produits de nettoyage pour la maison at aux additifs utilisés dans les piscines	EN ISO 10545-13	GB min.	GB min.
 Resistenza ad acidi e basi a bassa concentrazione Resistance to acids and bases at low concentrations Beständigkeit gegen Säuren und Basen niedriger Konzentration - Résistant aux acides et basiques à faible concentration	EN ISO 10545-13	indicata dal produttore indicated by the producer vom Hersteller angegeben indiquée par le producteur	GLB min.

Proprietà chimiche Chemical properties Chemische Eigenschaften Propriétés chimiques

	Resistenza ad acidi e basi ad alta concentrazione Resistance to acids and bases at high concentrations Beständigkeit gegen Säuren und Basen hoher Konzentration Résistant aux acides et basiques à concentration élevée	EN ISO 10545-13	metodo di prova disponibile test method available Prüfverfahren vorhanden méthode d'essai disponible	GHB min.
	Cessione di piombo e cadmio - Lead and cadmium losses - Abgabe von Pb und Cd - Perte de plomb et cadmium	EN ISO 10545-15	metodo di prova disponibile test method available Prüfverfahren vorhanden méthode d'essai disponible	disponibile a richiesta - available if required - vorhanden wenn erforderlich - disponible sur demande

Altre prove Other tests Weiteren Prüfungen Autres essais

prova test Prüfungen essai	metodo di prova test methods Prüfverfahren méthods d'essai	requisiti requirements Anforderungen exigences	risultati Vogue Vogue results Vogue Ergebnisse résultats Vogue	
	Resistenza dei colori alla luce - Resistance of the colors to the light - Lichtsfestigkeit der Farben - Résistance des couleurs à la lumière	DIN 51094	non previsto - not contemplated nicht vorgesehen - pas prévu	garantita - granted - garantiert - garantie
	Reazione al fuoco - Reaction to the fire - Reaktion bei Feuer - Réaction au feu	senza prova without test ohne Prüfung sans essai	decisione 96/603/CE decision 96/603/CE - Entscheidung 96/603/CE - décision 96/603/CE	classe A1

Determinazione della pulibilità e analisi microbatterica

I materiali di Ceramica Vogue possono considerarsi a tutti gli effetti antibatterici in quanto, previo accurata pulizia con prodotti specifici, non favoriscono il proliferare dei batteri (prova di laboratorio disponibile).

Determination of cleanability and microbacterial analysis

Ceramica Vogue materials may be considered antibacterial for all intents and purposes, as they do not promote the proliferation of bacteria provided they are properly cleaned using appropriate cleaning products (laboratory tests available).

Bestimmung der Reinigbarkeit und mikrobakterielle Analyse

Die Materialien von Ceramica Vogue können in jeder Hinsicht als antibakteriell betrachtet werden, da sie nach gründlicher Reinigung mit spezifischen Produkten die Bakterienverbreitung nicht begünstigen (Laborprobe verfügbar).

Détermination de la nettoyabilité et analyse microbactérienne

Les matériaux de Ceramica Vogue peuvent être considérés anti-bactériens dans la mesure où, grâce à un nettoyage soigné avec des produits adaptés, ils ne favorisent pas la prolifération des bactéries (test de laboratoire disponible).

Conformità alla Normativa

Il materiale Ceramica Vogue (prima scelta) è conforme a quanto previsto dalla normativa UNI EN 14411-2012 - Appendice H. Il sistema di gestione applica quanto previsto dalle Norme della Serie ISO 9000, ISO 14000 e dal Regolamento CE761/2001 EMAS. L'intero ciclo produttivo è dotato di Autorizzazione Integrata Ambientale, ai sensi dell'art. 4 D.Lgs 372/99 (I.P.P.C)

Conformity to Standards

Ceramica Vogue material (best quality) complies with the provisions of standard UNI EN 14411-2012 – Appendix H. The management system applies the provisions of the Standards in the series ISO 9000, ISO 14000 and the CE761/2001 EMAS Regulation. The whole production cycle is covered by an Integrated Environmental Authorisation, pursuant to Art. 4 of Italian Legislative Decree (D.Lgs) 372/99 (I.P.P.C)

Konformität mit den Bestimmungen

Das Material von Ceramica Vogue (erste Wahl) entspricht den Vorgaben der Bestimmung UNI EN 14411-2012 - Anhang H. Das Managementsystem wendet die Vorgaben der Bestimmungen der Reihe ISO 9000, ISO 14000 und der Regelung CE 761/2001 EMAS an. Der gesamte Produktionszyklus ist mit integrierter Umweltgenehmigung gemäß Art. 4 der Gesetzesverordnung 372/99 ausgestattet (I.P.P.C)

Conformité à la Norme

Le matériau Ceramica Vogue (premier choix) est conforme aux dispositions de la norme UNI EN 14411-2012 - Annexe H. Le système de gestion applique les dispositions de la norme de la série ISO 9000, ISO 14000 et du Règlement CE 761/2001 EMAS. L'ensemble du cycle de production fait l'objet d'une Autorisation environnementale intégrée en vertu de l'art. 4 du D.L. 372/99 (IPPC).

Appendice P P Appendix P Anhang Annexe P

EN ISO 10545-5: Determinazione della resistenza all'impatto mediante la misurazione del coefficiente di restituzione: Questa prova è destinata solo a prove su piastrelle che sono utilizzate in aree in cui la resistenza all'urto è considerata essere di particolare importanza. Il requisito normale per applicazioni sottoposte a basse sollecitazioni è un coefficiente di restituzione di 0,55. Per applicazioni sottoposte a sollecitazioni pesanti si richiederebbero valori più alti.

EN ISO 10545-14: Determinazione della resistenza alle macchie: La prova è obbligatoria per le piastrelle smaltate. Per le piastrelle non smaltate, se la macchiatura può costituire un problema, si raccomanda di consultare il fabbricante. Questo metodo non è inteso per le variazioni temporanee di colore che si possono verificare in certi tipi di piastrelle smaltate a causa dell'assorbimento di acqua nel supporto sotto lo smalto.

EN ISO 10545-5: Determination of impact resistance by measurement of the coefficient of restitution: This test is only applied on tiles to be used in areas where the impact resistance is of particular interest. The normal requirement for light uses is a restitution coefficient of 0,55. Higher values would be asked for heavy uses.

EN ISO 10545-14: Determination of resistance to stains: The test is compulsory for glazed tiles. If stains may be a problem for unglazed tiles please refer to the manufacturer. This test is not to be used for the temporary colour variations which may appear in certain types of glazed tiles because of the water absorption of the body under the glaze.

EN ISO 10545-5: Bestimmung der Schlagfestigkeit durch Messung des Ruckprallkoeffizienten: Diese Proben sind nur für jene Fliesen gedacht, welche einer normalen Druck- und Schlagkraft ausgesetzt und somit einer besonderen Gütekategorie zuzuordnen sind. Als normale Requisite dieser Prüfung, in regelmäßigen Abständen,mäßigem Druck ausgesetzt ist, liegt der Widerstand bei 0,55; bei stärkerer Anwendung sind höhere Werte erforderlich.

EN ISO 10545-14: Bestimmung der Beständigkeit gegen Fleckenbildner: Eine Pflichtprüfung für glasierte Fliesen. Bei unglasierten Fliesen sollte man, sofern nicht zu entfernende Fleckenbildung ein Problem stellen, beim Hersteller den Rat einholen. Dies ist bei glasierten Fliesen, bei vorübergehenden Farbveränderung, hervorgerufen durch der Feuchtigkeit unterhalb der Glasur, nicht nötig.

EN ISO 10545-5: Détermination du coefficient de restitution à l'impact: Ce test est destiné uniquement à carreaux utilisés dans zones où la résistance aux chocs est considérée d'importance spécifique. Le requis normal pour applications soumises à faibles sollicitations est un coefficient de restitution de 0,55. pour applications soumises à sollicitations plus importantes des valeurs plus haut sont demandés.

EN ISO 10545-14: Détermination de la résistance aux taches: Le test est obligatoire pour les carreaux émaillés. Pour les carreaux non émaillés, si les taches peuvent constituer un problème, veuillez consulter le fabricant. Cette méthode n'est pas à utiliser vers les variations temporaires de couleur pouvant se vérifier sur certaines types de carreaux émaillés suite à l'absorption d'eau par le support en dessous de l'émail.

Appendice N N Appendix N Anhang Annexe N

Classificazione delle piastrelle smaltate per pavimento in base alla loro resistenza all'abrasione

Questa classificazione approssimativa viene fornita solo a scopo di guida (vedere ISO 10545-7). Non dovrebbe essere utilizzata per fornire prescrizioni di prodotto in relazione a requisiti particolari.

Classe 0: piastrelle in questa classe non sono consigliate per il rivestimento dei pavimenti

Classe 1: rivestimenti di pavimenti in aree soggette a calpestio con scarpe a suola morbida o a piedi nudi senza sporco abrasivo (per esempio bagni e camere da letto in edifici residenziali, senza accesso diretto dall'esterno).

Classe 2: Rivestimenti di pavimenti in aree soggette a calpestio con scarpe a suola morbida o normale con, tutt'al più, piccoli quantitativi occasionali di sporco abrasivo (per esempio stanze nelle zone giorno di abitazioni private, ad eccezione di cucine, ingressi ed altre stanze ad alto traffico). Questo non si applica nel caso di calzature non normali, quali ad esempio scarpe chiodate.

Classe 3: Rivestimento di pavimenti in aree soggette a calpestio con scarpe normali e con presenza frequente di piccole quantità di sporco abrasivo (per esempio cucine di edifici residenziali, sale, corridoi, balconi, logge e terrazze). Questo non si applica nel caso di calzature non normali, quali ad esempio scarpe chiodate.

Classe 4: Rivestimenti di pavimenti in aree soggette a calpestio da traffico ordinario con sporco abrasivo, per cui le condizioni sono più severe di quelle riportate in classe 3 (per esempio ingressi, cucine commerciali, hotel, negozi ed aree vendita).

Classe 5: Rivestimenti di pavimenti soggetti a traffico pedonale intenso per periodi di tempo prolungati con sporco abrasivo, cosicché le condizioni sono le più severe nelle quali si possano utilizzare piastrelle smaltate per pavimento (per esempio aree pubbliche come centri commerciali, sale di aeroporti, ingressi di hotel, passaggi pedonali pubblici e applicazioni industriali).

Questa classificazione è valida per le applicazioni riportate in condizioni normali. Si dovrebbero prendere in considerazione le scarpe, il tipo di traffico ed i metodi di pulizia prevedibili, ed i pavimenti dovrebbero essere adeguatamente protetti dallo sporco abrasivo all'ingresso di edifici mediante interposizione di sistemi di pulizia delle scarpe. In casi estremi di traffico molto pesante e di abbondanza di sporco abrasivo, si possono prendere in considerazione piastrelle non smaltate per pavimento del gruppo I.

Classification of glazed floor tiles based on resistance to abrasion

This approximate classification is to be intended as a guide (see ISO 10545-7). It should not be used for product prescriptions related to specific requirements.

Class 0: Tiles in this class are not recommended for floor coverings.

Class 1:

Floor coverings in barefoot areas or with use of shoes with soft soles without abrasive dirt (for example bathrooms and bedrooms in residential buildings, without direct access from outside).

Class 2: Floor coverings in areas where using shoes with soft or normal soles and with eventual small quantities of abrasive dirt (for example the day-rooms in private houses except kitchens, entrances and other rooms with high traffic). This is not valid for not normal footwear, as for example hobnail shoes.

Class 3:

Floor coverings in areas where using normal shoes with frequent presence of small quantities of abrasive dirt (for example kitchens in residential buildings, living rooms, entrances, balconies, verandah and terraces). This is not valid for not normal footwear, as for example hobnail shoes.

Class 4: Floor coverings in ordinary traffic areas with abrasive dirt, therefore with worst conditions than in Class 3 (for example entrances, commercial kitchens, hotel, shops and selling areas)

Class 5: Floor coverings in areas with high pedestrian traffic for extended times and with abrasive dirt, so that the conditions are the worst where you can use glazed floor tiles (for example public areas like commercial centers, airport halls, hotel entrances, public pedestrian crossings and industrial applications).

This classification is valid for applications in standard conditions. Shoes, type of traffic and foreseeable cleaning systems should be taken in consideration and the floors should properly be protected from abrasive dirt at the building entrances through shoes cleaning systems. In extreme situations of very heavy traffic and lot of abrasive dirt, unglazed floor tiles of Group I can be taken in consideration.

Klassifizierung der glasierten Bodenfliesen gem. der Abriebwerte

Die nachstehende Klassifizierung soll als allgemeiner und unverbindlicher Hinweis der verschiedenen Einsatzbereiche dienen (siehe ISO 10545-7).

Klasse 0: Diese Fliesen sind nicht für die Verkleidung von Fußböden geeignet.

Klasse 1: Verkleidung von Fußböden mit äußerst geringer Beanspruchung z.B. Sanitär- oder Schlafräume ohne direkten Zugang von außen.

Klasse 2:

Leichte Beanspruchung mit weichen Schuhsohlen z.B. Privater Wohnbau mit Ausnahme von Küchen, Eingangsbereich und sonstige, eher stark begangene Bereiche.

Klasse 3: Mittlere Beanspruchung wie z.B. der gesamte Wohnraum inkl. Küche Loggien und Terrassen mit mäßigem Verschmutzung. Kein grobes Schuhwerk!

Klasse 4: Bodenbeläge mit stärkere Beanspruchung, also Flächen mit höherem Benutzungsgrad wie bei Klasse 3. wie z.B. Eingänge, Verkauf- und Wirtschaftsräume, Hotels und Büros.

Klasse 5: Flächen mit starkem Beanspruchungsgrad wo glasierte Fliesen einen sehr hohe Widerstandsfähigkeit gegen Abrieb ausweisen müssen wie z.B. Bereiche mit erhöhtem Publikumsverkehr wie Einkaufscenter, Flughallen, Restaurants Banken usw.

Diese Klassifizierung ist für normale Umstände gültig. Man sollte bei der Bewertung immer auf die Gattung des Schuhwerks, die Höhe der Beanspruchung, die Art der möglichen Verschmutzung und die voraussehbaren Reinigungs- und Pflegemaßnahmen in Betracht ziehen. Wo möglich, ist eine Schmutzschleuse anzuraten, wo Scheuerpartikel hängen bleiben und den Bodenbelag nicht zusätzlich belasten. Stark oder extrem stark zu belastende Bodenbeläge sollen mit unglasiertem Steinzeug der Gruppe I verkleidet werden.

Classification des carreaux émaillés pour revêtements de sol par apport à leur résistance à l'abrasion

Cette classification approximative est fournie uniquement avec e but d'une guide (voir ISO 10545-7). Elle ne devrait pas être utilisée afin de fournir prescriptions de produit par apport à requis particuliers.

Classe 0: Les carreaux dans cette classe sont déconseillés pour les revêtements des sols

Classe 1: Revêtement de sols dans lieux sujet à passage avec chaussures à semelle souple ou à pieds nus sans saleté abrasive (par exemple salles de bains et chambres à coucher en bâtiments résidentiels, sans accès direct de l'extérieur)

Classe 2: Revêtement de sols dans lieux sujet à passage avec chaussures à semelle souple ou normale avec au maximum petites quantités de saleté abrasive (par exemple pièces des zones à jours de logements privés, exceptés cuisines, entrées et autres pièces à fort passage). Ceci n'est pas applicable avec chaussures anormales, comme par exemple chaussures avec clous.

Classe 3: Revêtement de sols dans lieux sujet à passage avec chaussures à semelle normale ou avec une présence fréquente de petites quantités de saleté abrasive (par exemple cuisines résidentielles, salons, couloirs et terrasses) Ceci n'est pas applicable avec chaussures anormales, comme par exemple chaussures avec clous.

Classe 4: Revêtement de sols dans lieux sujet à passage de trafic ordinaire en présence de saleté abrasive, donc les conditions étant plus sévères de celles en classe 3 (par exemple entrées, cuisines commerciales, hôtels, commerces et aires de vente).

Classe 5: revêtements de sols sujets à trafic piéton intensif pour périodes prolongées en présence de saleté abrasive, étant les conditions les plus sévères d'utilisation des carreaux émaillés pour revêtement de sols (par exemple zones publiques type centres commercial, hall d'aéroport, entrées d'hôtel, passages piétons et applications industrielles).

Cette classification est valable pour les applications en conditions normales. Il faudrait prendre en considération les chaussures, la typologie de trafic et les méthodes d'entretiens prévus, et les surfaces devraient être correctement protégées de la saleté abrasive à l'entrée des bâtiments par l'interposition de systèmes de nettoyage des chaussures. Dans des cas extrêmes de passage très intensif et d'abondance de saleté abrasive, il est possible prendre en considération carreaux non-émaillés pour revêtements de sols du Groupe I.

Vogue System Flooring R10 B (A+B)

prova test Prüfungen essai	metodo di prova test methods Pruefverfahren méthods d'essai	requisiti requirements Anforderungen exigences				risultati Vogue Vogue results Vogue Ergebnisse résultats Vogue
 <p>determinazione proprietà antiscivolo: Determination of the anti-slip characteristics: Bestimmung der rutschemmenden Eigenschaft: Détermination des propriétés antiglissance:</p>	<p>DIN 51130 grado scivolosità non-skid characteristics Rutschfestigkeitswert coefficient de glissance</p>	<p>R9 aderenza normale normal adhesion normale Adhäsion adhérence normale $6^\circ \leq \alpha \text{ tot} \leq 10^\circ$</p>	<p>R10 aderenza media medium adhesion mittlere Adhäsion adhérence moyenne $10^\circ \leq \alpha \text{ tot} \leq 19^\circ$</p>	<p>R11 aderenza elevata high adhesion hohe Adhäsion adhérence élevée $19^\circ \leq \alpha \text{ tot} \leq 27^\circ$</p>	<p>α = angolo di inclinazione inclination angle Neigungswinkel angle de inclinaison</p>	R10
		<p>A aderenza media medium adhesion mittlere Adhäsion adhérence moyenne $\geq 12 < 18$</p>	<p>B aderenza elevata high adhesion hohe Adhäsion adhérence élevée $\geq 18 < 24$</p>	<p>C aderenza forte strong adhesion starke Adhäsion adhérence forte ≥ 24</p>		B (A+B)
<p>coefficiente di attrito: (1) asciutto (cuoio) (2) bagnato (gomma) Coefficient of friction: (1) dry (leather) (2) wet (Rubber) Reibungsbeiwert: (1) trocken (Haut) (2) nass (Gummi) Coefficient de frottement: (1) sec (cuir) (2) mouillé (caoutchouc)</p>	B.C.R.A.	<p>$\mu \leq 0,19$ scivolosità pericolosa dangerous slipperiness sehr hohe Rutschgefahr glissance dangereuse</p>	<p>$0,20 \leq \mu \leq 0,39$ scivolosità eccessiva extreme slipperiness hohe Rutschgefahr glissance excessive</p>	<p>$0,40 \leq \mu \leq 0,74$ attrito soddisfacente satisfactory friction befreidende Reibung frottement satisfaisant</p>	<p>$\mu \geq 0,75$ attrito eccellente excellent friction hervorragende Reibung frottement excellent</p>	<p>(1) $\mu > 0,48$ (2) $\mu > 0,42$</p>

Vogue System Grip R11 C (A+B+C)

prova test Prüfungen essai	metodo di prova test methods Pruefverfahren méthods d'essai	requisiti requirements Anforderungen exigences				risultati Vogue Vogue results Vogue Ergebnisse résultats Vogue
 <p>determinazione proprietà antiscivolo: Determination of the anti-slip characteristics: Bestimmung der rutschemmenden Eigenschaft: Détermination des propriétés antiglissance:</p>	<p>DIN 51130 grado scivolosità non-skid characteristics Rutschfestigkeitswert coefficient de glissance</p>	<p>R9 aderenza normale normal adhesion normale Adhäsion adhérence normale $6^\circ \leq \alpha \text{ tot} \leq 10^\circ$</p>	<p>R10 aderenza media medium adhesion mittlere Adhäsion adhérence moyenne $10^\circ \leq \alpha \text{ tot} \leq 19^\circ$</p>	<p>R11 aderenza elevata high adhesion hohe Adhäsion adhérence élevée $19^\circ \leq \alpha \text{ tot} \leq 27^\circ$</p>	<p>α = angolo di inclinazione inclination angle Neigungswinkel angle de inclinaison</p>	R11
		<p>A aderenza media medium adhesion mittlere Adhäsion adhérence moyenne $\geq 12 < 18$</p>	<p>B aderenza elevata high adhesion hohe Adhäsion adhérence élevée $\geq 18 < 24$</p>	<p>C aderenza forte strong adhesion starke Adhäsion adhérence forte ≥ 24</p>		C (A+B+C)
<p>coefficiente di attrito: (1) asciutto (cuoio) (2) bagnato (gomma) Coefficient of friction: (1) dry (leather) (2) wet (Rubber) Reibungsbeiwert: (1) trocken (Haut) (2) nass (Gummi) Coefficient de frottement: (1) sec (cuir) (2) mouillé (caoutchouc)</p>	B.C.R.A.	<p>$\mu \leq 0,19$ scivolosità pericolosa dangerous slipperiness sehr hohe Rutschgefahr glissance dangereuse</p>	<p>$0,20 \leq \mu \leq 0,39$ scivolosità eccessiva extreme slipperiness hohe Rutschgefahr glissance excessive</p>	<p>$0,40 \leq \mu \leq 0,74$ attrito soddisfacente satisfactory friction befreidende Reibung frottement satisfaisant</p>	<p>$\mu \geq 0,75$ attrito eccellente excellent friction hervorragende Reibung frottement excellent</p>	<p>(1) $\mu > 0,70$ (2) $\mu > 0,58$</p>

Vogue System Flooring40 R10

prova test Prüfungen essai	metodo di prova test methods Pruefverfahren méthods d'essai	requisiti requirements Anforderungen exigences					risultati Vogue Vogue results Vogue Ergebnisse résultats Vogue
 <p>determinazione proprietà antiscivolo: Determination of the anti-slip characteristics: Bestimmung der rutschemmenden Eigenschaft: Détermination des propriétés antiglissance:</p>	<p>DIN 51130 grado scivolosità non-skid characteristics Rutschfestigkeitswert coefficient de glissance</p>	<p>R9 aderenza normale normal adhesion normale Adhäsion adhérence normale $6^\circ \leq \alpha \text{ tot} \leq 10^\circ$</p>	<p>R10 aderenza media medium adhesion mittlere Adhäsion adhérence moyenne $10^\circ \leq \alpha \text{ tot} \leq 19^\circ$</p>	<p>R11 aderenza elevata high adhesion hohe Adhäsion adhérence élevée $19^\circ \leq \alpha \text{ tot} \leq 27^\circ$</p>	<p>α = angolo di inclinazione inclination angle Neigungswinkel angle de inclinaison</p>	<p>R10</p>	

Vogue System Grip40 B (A+B)

prova test Prüfungen essai	metodo di prova test methods Pruefverfahren méthods d'essai	requisiti requirements Anforderungen exigences					risultati Vogue Vogue results Vogue Ergebnisse résultats Vogue
 <p>determinazione proprietà antiscivolo di zone bagnate a piedi nudi: Determination of the anti-slip characteristics for barefoot wet areas: Bestimmung der rutschemmenden Eigenschaft für nassbelastete Barfußbereiche: Détermination des propriétés antiglissance dans environs baignés à pieds nus:</p>	<p>DIN 51097 angolo inclinazione (°) inclination angle (°) Neigungswinkel (°) angle d'inclinaison (°)</p>	<p>A aderenza media medium adhesion mittlere Adhäsion adhérence moyenne $\geq 12 < 18$</p>	<p>B aderenza elevata high adhesion hohe Adhäsion adhérence élevée $\geq 18 < 24$</p>	<p>C aderenza forte strong adhesion starke Adhäsion adhérence forte ≥ 24</p>		<p>B (A+B)</p>	

Vogue Pool Bump c (A+B+C) v6

prova test Prüfungen essai	metodo di prova test methods Pruefverfahren méthods d'essai	requisiti requirements Anforderungen exigences					risultati Vogue Vogue results Vogue Ergebnisse résultats Vogue
 <p>determinazione proprietà antiscivolo di zone bagnate a piedi nudi: Determination of the anti-slip characteristics for barefoot wet areas: Bestimmung der rutschemmenden Eigenschaft für nassbelastete Barfußbereiche: Détermination des propriétés antiglissance dans environs baignés à pieds nus:</p>	<p>DIN 51097 angolo inclinazione (°) inclination angle (°) Neigungswinkel (°) angle d'inclinaison (°)</p>	<p>A aderenza media medium adhesion mittlere Adhäsion adhérence moyenne $\geq 12 < 18$</p>	<p>B aderenza elevata high adhesion hohe Adhäsion adhérence élevée $\geq 18 < 24$</p>	<p>C aderenza forte strong adhesion starke Adhäsion adhérence forte ≥ 24</p>		<p>C (A+B+C)</p>	

 <p>valutazione dello spazio di dislocazione assessment of displacement space Beurteilung des Verlegungsraums. estimation de l'espace de positionnement</p>	<p>DIN 51130 volume cavità deflusso (cm³/dm²) Volume of outflow cavity Abflusskavitätswolumen volume cavité d'écoulement</p>	<p>V4 $4 \text{ cm}^3/\text{dm}^2$</p>	<p>V6 $6 \text{ cm}^3/\text{dm}^2$</p>	<p>V8 $8 \text{ cm}^3/\text{dm}^2$</p>	<p>V10 $10 \text{ cm}^3/\text{dm}^2$</p>	<p>V6</p>
---	---	--	--	--	--	------------------

ASTM Test Results

Test	Test methods	Requirements	Vogue results
 Water absorption (%)	C 373	0,5% to 3%	2,5 %
 Breaking strenght in N	C 648	≥ 250 lbf	> 265 lbf
 Chemical resistance	C 650	No requirement	Pass
 Stain resistance	C 1378	Pass	Pass
 Crazing resistance	C 424	Pass	Pass
 Frost resistance	C 1026:2013	As reported	Pass
 Bond strength of ceramic tile to portland cement	C 482	≥ 50 psi	214 psi
 Thermal shock	C484	No sample must show visible effects	Pass

Vogue System Flooring R10 B (A+B)

Test	Test methods	Requirements	Vogue results
Dry Coefficient of friction	C 1028	anti slip > 0,60	0,77
Wet Coefficient of friction	C 1028	anti slip > 0,60	0,68

Vogue System Grip R11 C (A+B+C)

Test	Test methods	Requirements	Vogue results
Dry Coefficient of friction	C 1028	anti slip > 0,60	0,71
Wet Coefficient of friction	C 1028	anti slip > 0,60	0,79

Marchatura CE

Il Regolamento Europeo 305/2011 (CPR) abroga la Direttiva 89/106/CEE sui prodotti da costruzione (CPD) introducendo dal 01/07/2013 alcune importanti novità nell'ambito della Marchatura CE dei prodotti da costruzione.

La Dichiarazione di Conformità dei prodotti da costruzione viene sostituita dalla Dichiarazione di Prestazione (DoP) con diverso significato e contenuto.

In assenza di questa dichiarazione i prodotti non possono circolare all'interno dei confini dell'Unione Europea.

La presenza del marchio CE su tutti gli imballi di Ceramica Vogue attesta che, il prodotto in essi contenuto è conforme a quanto dichiarato nelle schede tecniche, e la costanza delle prestazioni del prodotto è stata verificata ed attestata a garanzia dell'utilizzatore.

CE mark

European Regulation 305/2011 (CPR) abrogates Directive 89/106/EEC concerning construction products, introducing a number of important changes concerning the CE mark on construction products effective 01/07/2013.

The Declaration of Conformity for construction products is replaced by the Declaration of Performance (DoP), with a different meaning and different content.

Products cannot circulate within the European Union without this declaration.

The presence of the CE mark on all Ceramica Vogue packages demonstrates that the product contained in them conforms to the declarations of the technical information sheets and that the constancy of the product's performance has been tested as a guarantee for the user.

CE-Kennzeichnung

Die europäische Regelung 305/2011 (BPR) ersetzt die Richtlinie 89/106/EWG hinsichtlich Bauprodukten, indem ab dem 01.07.2013 einige wichtige Neuheiten im Rahmen der CE-Kennzeichnung der Bauprodukte eingeführt werden.

Die Konformitätserklärung der Bauprodukte wird von der Leistungserklärung (LE) mit anderer Bedeutung und anderem Inhalt abgelöst.

In Ermangelung dieser Erklärung dürfen die Produkte innerhalb der Grenzen der EU nicht mehr in Umlauf gebracht werden.

Das Vorliegen des CE-Zeichens auf allen Verpackungen von Ceramica Vogue bescheinigt, dass das darin enthaltene Produkt den Erklärungen in den technischen Datenblättern entspricht und dass die Konstanz der Leistungen des Produkts als Garantie des Benutzers überprüft und bescheinigt wurde.

Symbole CE

Le règlement européen 305/2011 (CPR) abroge la directive 89/106/CEE sur les produits de construction (CPD) en introduisant depuis le 01/07/2013 certaines nouveautés importantes dans le cadre du symbole CE des produits de construction.

La déclaration de conformité des produits de construction est remplacée par la déclaration de prestation (DoP) avec un sens et un contenu différents.

En l'absence de cette déclaration, les produits ne peuvent pas circuler dans le territoire de l'Union Européenne.

La présence du symbole CE sur tous les emballages de Ceramica Vogue atteste que le produit qu'ils contiennent est conforme à ce qui est déclaré sur les fiches techniques, et que la constance des prestations du produit a été vérifiée et attestée comme garantie pour l'utilisateur.

Manutenzione e pulizia

La qualità di un rivestimento in piastrelle ceramiche dipende, oltre che da una buona progettazione e da una corretta posa, anche dalla cura che verrà rivolta alle superfici.

Le piastrelle Ceramica Vogue in gres porcellanato smaltato sono resistenti, igieniche e facili da pulire, non richiedono particolari cure ma solo l'applicazione di alcune elementari norme di pulizia.

E' importante distinguere tra pulizia di fine cantiere e pulizia ordinaria.

PULIZIA DI FINE CANTIERE

Oltre a mantenere sempre protette le superfici durante la fasi di cantiere, è di fondamentale importanza curare la prima pulizia. Questa operazione ha lo scopo di eliminare ogni traccia e residuo di posa dalla superficie delle piastrelle. Prima del lavaggio è importante rimuovere con un aspiratore lo sporco grossolano evitando di rigare la superficie delle piastrelle. La pulizia deve essere fatta con prodotti in commercio tipo Deterdek (www.filachim.com), Keranet (www.mapei.com) o prodotti similari.

Si raccomanda di seguire rigorosamente le indicazioni riportate sulle schede tecniche dei prodotti utilizzati e comunque di fare delle prove dei prodotti di pulizia su una piccola porzione di una piastrella prima di eseguire la pulizia totale della superficie.

PULIZIA ORDINARIA

Per la pulizia ordinaria è bene usare prodotti in grado di eliminare eventuali macchie di sporco senza però intaccare la smaltatura superficiale, evitare quindi sostanze molto aggressive quali prodotti a base acida.

Usare semplici prodotti adatti alla pulizia della ceramica. Per migliorare l'efficacia dei detergenti diluirli con acqua calda.

NORME GENERALI

Sostanze abrasive o strumenti per la pulizia quali spugne abrasive o spazzole eccessivamente dure sono sconsigliati in quanto potrebbero provocare sulla superficie delle piastrelle graffi o segni impossibili poi da eliminare.

Sui prodotti con caratteristiche antiscivolo evitare assolutamente l'utilizzo di prodotti lavaincera o cere.

Nel caso di locali comunicanti con l'esterno è indispensabile utilizzare zerbini per ridurre l'apporto di agenti abrasivi.

Maintenance

The quality of a ceramic wall tile depends not only on proper design and laying, but also the care taken of the surface thereafter.

Ceramica Vogue glazed porcelain stoneware tiles are hard-wearing, hygienic and easy to clean. They require no particular maintenance other than the application of a number of simple cleaning rules.

It is important to distinguish between the cleaning to be carried out when the building work is complete and ordinary cleaning.

CLEANING AFTER BUILDING WORK IS COMPLETED

In addition to keeping surfaces protected during the various phases of the building work, it is of fundamental importance to ensure the tiles are cleaned properly for the first time once the building work is complete.

The purpose of this operation is to remove all traces and residue from the laying process from the surface of the tiles. Before washing the tiles, it is important to vacuum off the worst of the dirt, without scratching the surface of the tiles. Cleaning must be done using products such as Deterdek (www.filachim.com), Keranet (www.mapei.com) or similar.

The indications on the technical specifications of the products used must be followed very carefully, and all cleaning products should be tested on a small portion of a tile before proceeding to clean the whole surface.

ORDINARY CLEANING

For ordinary cleaning, it is best to use products able to remove any dirty marks without damaging the surface glaze, avoiding particularly aggressive (e.g. acid-based) products.

Use simple products suitable for cleaning ceramics. To improve the efficacy of the cleaning agents, dilute them in hot water.

GENERAL RULES

Abrasive substances or cleaning instruments such as abrasive sponges or excessively hard brushes should be avoided, because they could scratch the surface or leave marks that will be impossible to remove.

On products with anti-slip characteristics, wash and wax or wax products must not be used.

For areas that lead directly outdoors, mats must be used in order to limit the abrasive agents brought in.

Pflege und Reinigung

Die Qualität einer Verkleidung aus Keramikfliesen ist neben einer guten Planung und korrekten Verlegung auch von der Pflege abhängig, die den Oberflächen gewidmet wird.

Die Fliesen Ceramica Vogue aus glasiertem lackiertem Steingut sind resistent, hygienisch und leicht zu reinigen. Sie erfordern keine besondere Pflege sondern nur die Berücksichtigung einiger grundsätzlichen Reinigungsregeln.

Es ist wichtig, zwischen der Baustellenendreinigung und einer normalen Reinigung zu unterscheiden.

BAUSTELLENENDREINIGUNG

Die Oberflächen müssen während der Bauphase immer geschützt bleiben und außerdem ist es von absoluter Wichtigkeit, dass die erste Reinigung sorgfältig durchgeführt wird.

Hierzu müssen alle Spuren und Reste der Verlegung von den Fliesenoberflächen entfernt werden. Vor der Reinigung mit einem Staubsauger den groben Schmutz entfernen, dabei darauf achten, dass die Fliesenoberflächen nicht zerkratzt werden. Die Reinigung mit handelsüblichen Produkten, wie Deterdek (www.filachim.com), Keranet (www.mapei.com) oder ähnlich durchführen.

Es wird empfohlen, die Angaben auf den Datenblättern der verwendeten Produkte genau zu befolgen und in jedem Fall das Produkt auf einem kleinen Fliesenbereich zu testen, bevor die gesamte Fläche gereinigt wird.

NORMALE REINIGUNG

Für die normale Reinigung sollten Produkte verwendet werden, die eventuelle Flecken entfernen ohne die Glasur der Oberfläche anzugreifen - keine aggressiven oder säurehaltigen Mittel verwenden.

Einfache Produkte zur Fliesenreinigung verwenden. Für eine bessere Wirkung die Reinigungsmittel in heißem Wasser verdünnen.

ALLGEMEINE HINWEISE

Von Scheuermitteln oder Reinigungsgeräten, wie Scheuerschwämme oder harten Bürsten wird abgeraten, da sie die Oberfläche der Fliesen zerkratzen oder andere nicht entfernbare Spuren hinterlassen können.

Auf Produkten mit rutschhemmenden Eigenschaften dürfen auf keinen Fall wachshaltige Reinigungsmittel oder Bohnerwachs verwendet werden.

In Bereichen mit externem Zugang muss eine Matte verwendet werden, um die Verunreinigung mit scheuernden Komponenten zu verringern.

Entretien et nettoyage

Au-delà d'une conception intelligente et d'une pose dans les règles de l'art, la qualité d'un revêtement céramique dépend aussi du soin qui sera apporté aux surfaces.

Les carrelages Ceramica Vogue en grès cérame émaillé sont résistants, hygiéniques et faciles à nettoyer. Ils n'exigent aucun soin particulier, seulement quelques règles élémentaires de propreté.

Il est important de faire la différence entre le nettoyage de fin de chantier et le nettoyage ordinaire.

NETTOYAGE DE FIN DE CHANTIER

En plus de protéger les surfaces pendant toute la durée du chantier, il est fondamental de soigner le premier nettoyage.

Cette opération a pour but d'éliminer toute trace et résidu de pose présent à la surface du carrelage. Avant de procéder au lavage, il est important de passer l'aspirateur afin d'éliminer la saleté pour éviter de rayer les carreaux. Effectuer ensuite le nettoyage à l'aide de produits disponibles dans le commerce tels que Deterdek (www.filachim.com), Keranet (www.mapei.com) ou tout autre produit similaire.

Il est recommandé de suivre rigoureusement les indications figurant sur les fiches techniques des produits utilisés et, quoi qu'il en soit, de procéder à un essai sur une petite surface avant de passer au nettoyage du carrelage dans sa totalité.

NETTOYAGE ORDINAIRE

Pour le nettoyage ordinaire, il est préférable d'utiliser des produits en mesure d'éliminer toute trace éventuelle de saleté sans abîmer l'émail des carreaux. Les substances très agressives, à base acide notamment, sont donc à éviter.

Utiliser les produits habituellement conseillés pour nettoyer le carrelage. Pour améliorer l'efficacité des détergents, vous pouvez les diluer dans de l'eau chaude.

NORMES GENERALES

Les substances abrasives, les éponges abrasives ou encore les brosses excessivement dures sont déconseillées car elles risquent de rayer la surface des carreaux ou de laisser des traces qui pourraient s'avérer impossible à éliminer.

Sur les produits antidérapants, éviter absolument d'utiliser des produits lavants-cirants ou des cires.

Si le carrelage est posé sur des pièces qui communiquent avec l'extérieur, il est indispensable d'utiliser des tapis-brosses afin de limiter l'apport d'agents abrasifs.

Pezzi Speciali Special pieces Formteile Pièces spéciales

Quadra 2,5x20

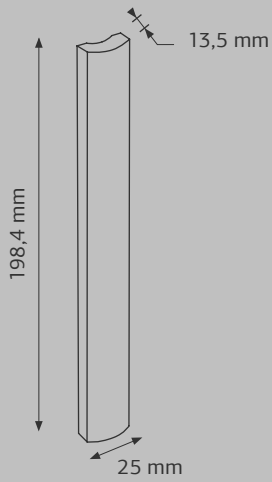

Stick 1,2x20

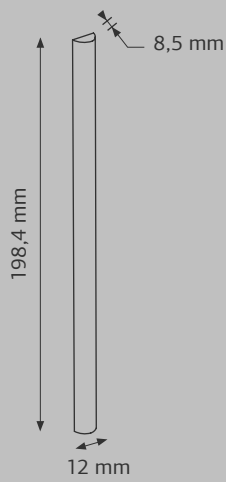

cod. M 2,5x20

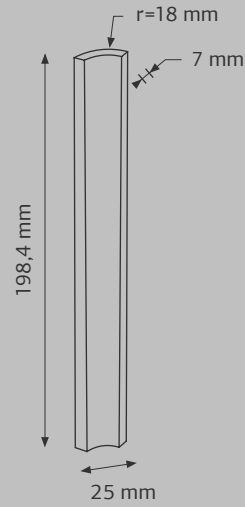

cod. N 2,5x20

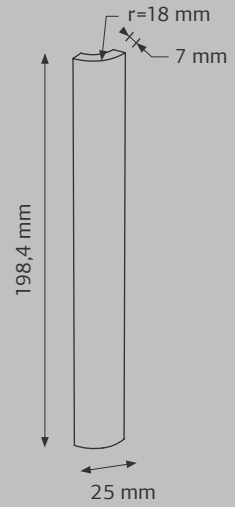

cod. W 2,5x10

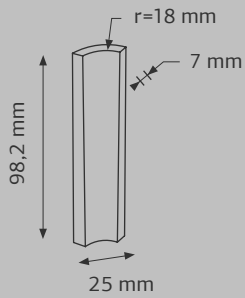

cod. K 2,5x10

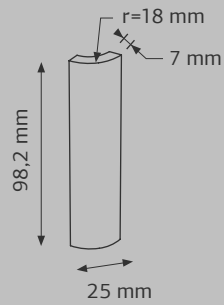

cod. G 2,5x10

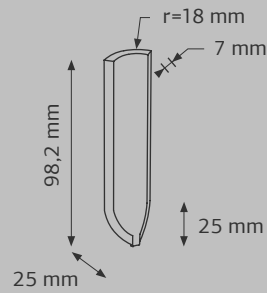

cod. H 2,5x10

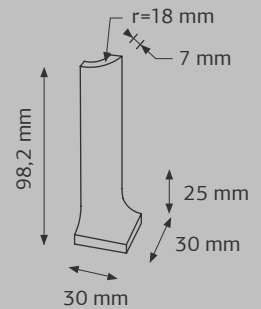

cod. C 2,5x2,5

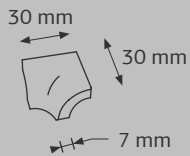

cod. D 2,5x2,5

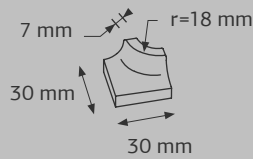

cod. F 2,5x2,5

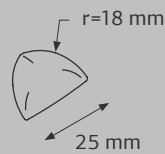

cod. E 2,5x2,5

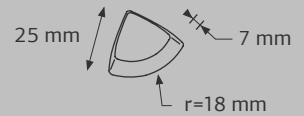

cod. X 10x20

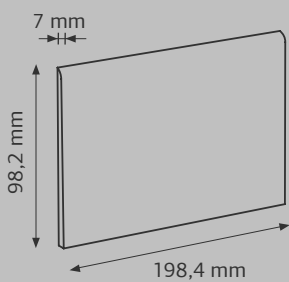

cod. U 10x10

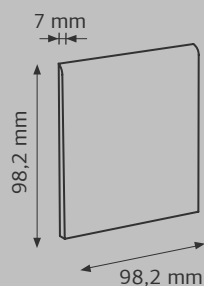

Battiscopa 9,5x40

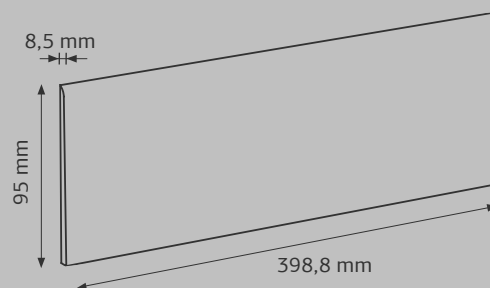

Pezzi Speciali Special pieces Formteile Pièces spéciales

cod. **I** 10x20

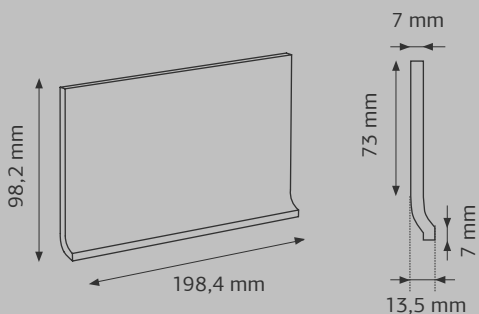

cod. **Z** 10x10

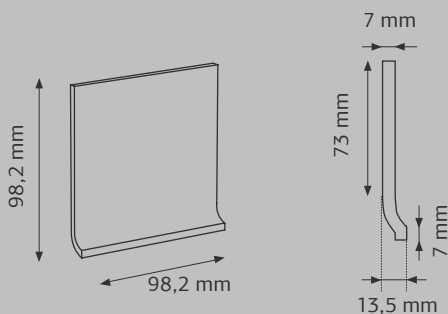

Bordo cod. **B** 10x10

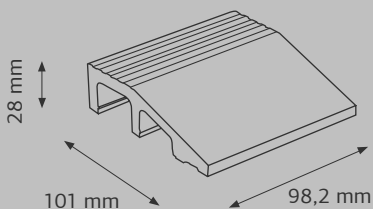

Spigolo cod. **E** 10x10

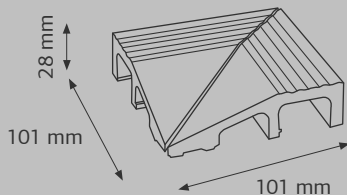

Angolo cod. **I** 10x10

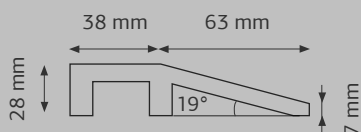
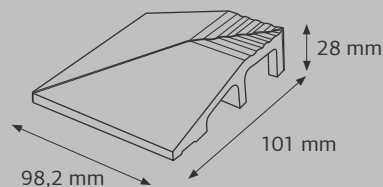

Special Pool Special Pool Special Pool Special Pool

cod. **BR** 6,3x20

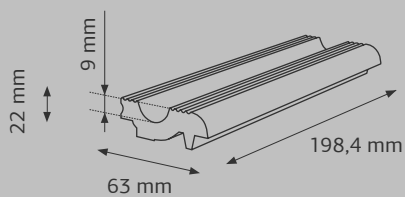

cod. **FU** 4,5x20

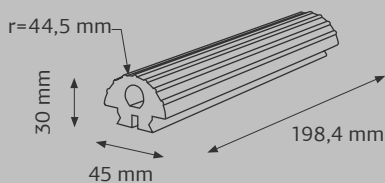

cod. **BC** 10x20

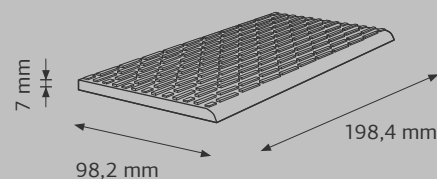

cod. **BR1** 6,3x10

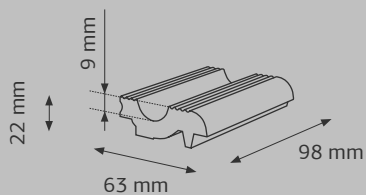

cod. **FU1** 4,5x10

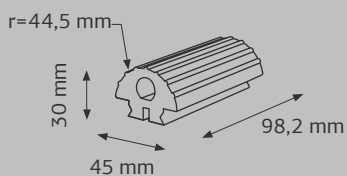

cod. **BC1** 10x10

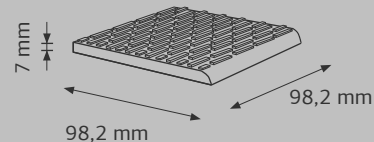

Fotografi:

LUCIANO BUSANI

ALBERTO NOVELLI

SANCEZ Y MONTORO

LUCA MORETTO

GABRIELE BASILICO

AFRITECTS

SANTI CALECA

ANTONIO PAPPALARDO

FRANCESCO SEMMOLA

MECCANICHE CREATIVE

Progetto:



Realizzazione:

Ufficio marketing interno

Stampa:

Arti Grafiche Biellesi - Candelo (BI)

Ufficio stampa:

info@sabrinagiacchetti.it

Stampato in Italia - Settembre 2013



www.ceramicavogue.it

Ceramica VOGUE

è un marchio di



Socio Ordinario
del GBC Italia

UFFICI e PRODUZIONE:

SS 143 Loc. Vergnasco - 13882 Cerrione (BI) ITALIA
tel. +39.015.672.1 - fax Italia +39.015.671.626
fax Export +39.015.671.352
e-mail: info@cervogue.com

SHOW ROOM:

Teatro Olimpia - Foro Buonaparte, 74 - 20121 Milano ITALIA
tel. +39.02.80.50.94.98 - fax +39.02.80.45.28
e-mail: showroom@altaeco.com

ПРЕДСТАВИТЕЛЬСТВО В РОССИИ:

117292 Москва ул. Дмитрия Ульянова, д.16, к.2, оф. 249
тел. +7 (495) 7249354 - 974 1692 - факс +7 (495) 5434261
e-mail: russia@altaeco.com

中國聯絡處:

e-mail: altaeco@126.com

MADE IN ITALY



www.ceramicavogue.it